



# BARRET®

ATTREZZATURE PER L'ALLENAMENTO DEI CAMPIONI  
TRAINING TOOLS FOR CHAMPIONS



**catalogo**  
**2024-2025**  
**brochure**

*GET READY FOR THE MATCH!*



## Barret Srl

Dal 1989 Barret Srl produce attrezzature tecniche per lo sport.

In particolare, l'Azienda si è affermata nel corso degli anni per la ideazione e realizzazione di strumenti di allenamento ormai divenuti indispensabili per la preparazione fisica, tecnica e tattica dei giocatori di calcio, così come per la preparazione degli atleti di molti altri sport, sia di squadra che individuali.

Barret offre la più ampia varietà di attrezzature quali sagome, ostacoli, delimitatori, birilli, paletti per slalom, archi di precisione, kit per calcio-tennis, forche, bande elastiche, slitte, plinti, tavolette propriocettive, telai con rete, muri in vetroresina, porte minicalcio, porte bifrontali, ridotte e regolamentari.

La qualità che contraddistingue i prodotti offerti e le numerose innovazioni proposte con continuità nel corso degli anni hanno permesso all'Azienda di affermarsi non solo sul mercato italiano, ma anche su quello internazionale.

Barret ha sviluppato nel tempo una preziosa collaborazione con Juventus FC, AC Milan e FC Internazionale fondamentale per permettere un interscambio di idee ed informazioni con i preparatori atletici della prima squadra e del settore giovanile, finalizzato al continuo miglioramento della funzionalità delle attrezzature tecniche per l'allenamento.

**I prodotti Barret, infatti, vengono utilizzati quotidianamente sui campi di allenamento de La Continassa, di Milanello e di Appiano Gentile per coadiuvare la preparazione fisica e tecnica di alcuni tra i migliori giocatori di calcio del mondo.**

Sarebbe impresa ardua ricordare tutti i Club nazionali ed internazionali e le Federazioni che hanno scelto più volte di acquistare le nostre attrezzature attraverso la rete distributiva italiana ed estera.

Cogliamo l'occasione per ringraziare i preparatori atletici ed i responsabili acquisti di Milan, Inter, Juventus, Roma, Lazio, Napoli, Sampdoria, Fiorentina, Udinese, Palermo, Torino, Empoli, Cagliari, Bologna, Sassuolo, Spal, Barcellona, Real Madrid, Bayern Monaco, PSG, Arsenal, Chelsea, Manchester City, Zenit e delle Nazionali di Calcio di Italia, Germania, Inghilterra, Francia, Spagna, Portogallo e Russia.

### Company Profile

*Founded in 1989, Barret Srl gained a foothold in the international football training equipment market by creating innovative tools which have become more and more essential during training sessions of pro athletes worldwide.*

*Barret manufactures products such as mannequins, hurdles, markers, cones, slalom poles, shooting arcs, soccer-tennis kits, heading trellises, all kinds of fiberglass and net rebounders, sledges, vaulting boxes, equilibrium boards, any size goals and mini goals.*

*The quality and variety of products introduced over the years make Barret the go-to company when a training camp is about to start.*

*Barret has a long history of working together with Juventus FC, AC Milan and FC Internazionale, three of the most prestigious clubs in football history: all the inputs and feedbacks received by their coaches always pushes Barret to shape and improve new products.*

*As a matter of fact Barret tools are used everyday at La Continassa, Milanello and Appiano Gentile Training Centers in order to constantly enhance some of the best world football players' athletic and technical performances.*

*It would be nearly impossible to name all professional Football Clubs and National Teams that have chosen to purchase Barret products through our distribution network.*

*However we would like to take this opportunity to thank clubs such as Milan, Inter, Juventus, Roma, Lazio, Napoli, Sampdoria, Fiorentina, Udinese, Palermo, Torino, Empoli, Cagliari, Bologna, Sassuolo, Spal, Barcellona, Real Madrid, Bayern Monaco, PSG, Arsenal, Chelsea, Manchester City, Zenit and the Italian, English, German, Spanish, Portuguese, French and Russian National Teams.*

# BARRET®

Le materie prime (i vari preparati plastici ed i profilati in polipropilene copolimero ed in PVC nei vari diametri, spessori e colori) utilizzate da BARRET per lo stampaggio e l'assemblaggio degli articoli in materiale plastico sono certificate dai nostri fornitori nel rispetto delle normative vigenti che impediscono l'utilizzo di sostanze ritenute tossiche per la salute dell'uomo e dell'ambiente.

*Barret manufactures plastic products in PVC and polypropylene such as dummies, cones, markers, hurdles, slalom poles etc. using only certified non toxic raw materials not dangerous for human beings and the environment.*



 **FORNITORE UFFICIALE**



**Centro Sportivo Luigi Berlusconi - Monza**



 **FORNITORE UFFICIALE**





 **FORNITORE UFFICIALE**



**Centro Sportivo Luigi Berlusconi - Monza**

**BARRET srl**  
**dal 1989**  
**since 1989**





**BARRET**  
Attrezzature per l'allenamento dei campioni  
Training Tools for champions

**BARRET s.r.l.**  
Via Maria Curie, 6/8  
Zona Ind. S. Pietro in Palazzi  
37010 Cecina (SI) - Italy  
Telefono (+39) 0584 642117  
Fax (+39) 0584 642115  
E-mail: info@barrengroup.com  
www.barrengroup.com



**BARRET**  
ATTREZZATURE PER L'ALLENAMENTO DEI CAMPIONI  
TRAINING TOOLS FOR CHAMPIONS

F.C. INTERNAZIONALE  
APPIANO GENTILE

**BARRET s.r.l.**  
Via Maria Curie, 6/8  
Zona Ind. S. Pietro in Palazzi  
37010 Cecina (SI) - Italy  
Telefono (+39) 0584 642117  
Fax (+39) 0584 642115  
E-mail: info@barrengroup.com  
www.barrengroup.com



**BARRET**  
ATTREZZATURE PER L'ALLENAMENTO DEI CAMPIONI  
TRAINING TOOLS FOR CHAMPIONS

F.C. INTERNAZIONALE  
CAMPO DI ALLENAMENTO APPIANO GENTILE  
F.C. INTERNAZIONALE TRAINING CENTRE

**BARRET s.r.l.**  
Via Maria Curie, 6/8  
Zona Ind. S. Pietro in Palazzi  
37010 Cecina (SI) - Italy  
Telefono (+39) 0584 642117  
Fax (+39) 0584 642115  
E-mail: info@barrengroup.com  
www.barrengroup.com



Catálogo 2008-2010  
2008-2010 Brochure

**BARRET**  
ATTREZZATURE PER L'ALLENAMENTO DEI CAMPIONI  
TRAINING TOOLS FOR CHAMPIONS

*"In ogni attività la passione  
è la parte più grande della difficoltà"*

F.C. Internazionale  
Centro sportivo Angelo Moratti  
Appiano Gentile

A.C. Milan  
Centro Sportivo Milanello

**BARRET s.r.l.**  
Via Maria Curie, 6/8  
Zona Ind. S. Pietro in Palazzi  
37010 Cecina (SI) - Italy  
Telefono (+39) 0584 642117  
Fax (+39) 0584 642115  
E-mail: info@barrengroup.com  
www.barrengroup.com



Catálogo 2010-2011  
2010-2011 Brochure

**BARRET**  
ATTREZZATURE PER L'ALLENAMENTO DEI CAMPIONI  
TRAINING TOOLS FOR CHAMPIONS

**BARRET s.r.l.**  
Via Maria Curie, 6/8  
Zona Ind. S. Pietro in Palazzi  
37010 Cecina (SI) - Italy  
Telefono (+39) 0584 642117  
Fax (+39) 0584 642115  
E-mail: info@barrengroup.com  
www.barrengroup.com



Catálogo 2013-2014  
2013-2014 Brochure

**BARRET**  
ATTREZZATURE PER L'ALLENAMENTO DEI CAMPIONI  
TRAINING TOOLS FOR CHAMPIONS

**BARRET s.r.l.**  
Via Maria Curie, 6/8  
Zona Ind. S. Pietro in Palazzi  
37010 Cecina (SI) - Italy  
Telefono (+39) 0584 642117  
Fax (+39) 0584 642115  
E-mail: info@barrengroup.com  
www.barrengroup.com



**BARRET**  
 ATTREZZATURE PER L'ALLENAMENTO DEI CAMPIONI  
 TRAINING TOOLS FOR CHAMPIONS



F.C. INTERNAZIONALE  
 CAMPO DI ALLENAMENTO APPIANO GENTILE  
 F.C. INTERNAZIONALE TRAINING CENTRE



**BARRET s.r.l.**  
 Via Maria Curie, 6/8  
 37023 Zorno (td) - S. Pietro in Palazzi  
 CECINA (SI) - Italy  
 telefono (+39) 0586 662115  
 fax (+39) 0586 662117  
 E-mail: info@barretsport.com  
 www.barretsport.com

**BARRET**  
 ATTREZZATURE PER L'ALLENAMENTO DEI CAMPIONI  
 TRAINING TOOLS FOR CHAMPIONS



Juventus Football Club - Torino  
 centro di allenamento  
 Training Center



**BARRET s.r.l.**  
 Via Maria Curie, 6/8  
 37023 Zorno (td) - S. Pietro in Palazzi  
 CECINA (SI) - Italy  
 telefono (+39) 0586 662115  
 fax (+39) 0586 662117  
 E-mail: info@barretsport.com  
 www.barretsport.com

**BARRET**  
 ATTREZZATURE PER L'ALLENAMENTO DEI CAMPIONI  
 TRAINING TOOLS FOR CHAMPIONS





**BARRET s.r.l.**  
 Via Maria Curie, 6/8  
 37023 Zorno (td) - S. Pietro in Palazzi  
 CECINA (SI) - Italy  
 telefono (+39) 0586 662115  
 fax (+39) 0586 662117  
 E-mail: info@barretsport.com  
 www.barretsport.com

Juventus Training Center - Vinova (TO)

**BARRET**  
 ATTREZZATURE PER L'ALLENAMENTO DEI CAMPIONI  
 TRAINING TOOLS FOR CHAMPIONS



COLLEGGIO  
 2014-2015  
 BLOCHIERE





**BARRET s.r.l.**  
 Via Maria Curie, 6/8  
 Zorno (td) - S. Pietro in Palazzi  
 37023 CECINA (SI) - Italy  
 telefono (+39) 0586 662115  
 fax (+39) 0586 662117  
 E-mail: info@barretsport.com  
 www.barretsport.com

**BARRET**  
 ATTREZZATURE PER L'ALLENAMENTO DEI CAMPIONI  
 TRAINING TOOLS FOR CHAMPIONS

2015-2016  
 BLOCHIERE

**BARRET**  
 ATTREZZATURE PER L'ALLENAMENTO DEI CAMPIONI  
 TRAINING TOOLS FOR CHAMPIONS



**BARRET s.r.l.**  
 Via Maria Curie, 6/8  
 Zorno (td) - S. Pietro in Palazzi  
 37023 CECINA (SI) - Italy  
 telefono (+39) 0586 662115  
 fax (+39) 0586 662117  
 E-mail: info@barretsport.com  
 www.barretsport.com

**BARRET srl**  
 dal 1989  
 since 1989

## NUOVI PRODOTTI - NEW PRODUCTS



pag. 88

**Art. CGG24**

**Cuscino gonfiabile con maniglie cm.70x50 per contrasto alle uscite alte del portiere**  
Inflatable cushion 70x50 cm. with handles for football goalkeeper exit training

**Art. S4DB**

**Scala doppia lunghezza m. 4 con 20 listelli piatti a distanza regolabile per esercizi di coordinazione motoria (compresa sacca per il trasporto)**

Double speed ladder length 4 meters with 20 adjustable flat rungs for quick step and coordination exercises, bag included

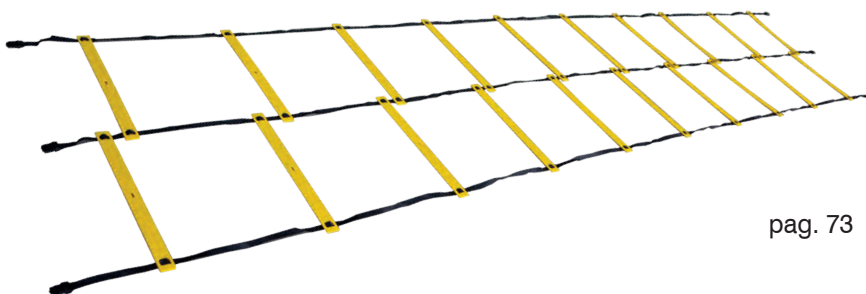

pag. 73

**Art. S3PP Set 3 piattaforme pliometriche con 3 diverse altezze: cm. 30, cm. 45 e cm. 60 - rivestimento antiscivolo sulla parte superiore e cuscinetti in gomma sotto ciascuna piattaforma per una maggiore sicurezza - impilabili per un pratico stoccaggio**

Set of 3 plyometric platforms with 3 different heights: 30 cm., 45 cm. and 60 cm. anti-skid coating on top and rubber pads under each platform for added safety. Stackable for practical storage



pag. 70



pag. 164

**Art. RC100**

**Bobina con fettuccia elastica per delimitazione temporanea campo da gioco.**

Con questo nastro la marcatura può essere comodamente installata su campi senza gesso o vernice, e può essere rimossa senza lasciare residui dopo una partita o un allenamento. Il nastro può essere facilmente srotolato dalla bobina, e poi riavvolto con la stessa facilità.

**Lunghezza 100 metri (ma può estendersi fino a circa il doppio)**

**Larghezza cm. 2,5 - colore bianco - 25 picchetti in plastica inclusi per il fissaggio**

Spool with elastic tape for temporary delimitation of the playing field. With this tape the marking can be conveniently installed on pitches with no chalk or paint, and can be removed without leaving residue after a match or training. The tape can be easily unwound from the spool, and then rewound just as easily.

Length 100 meters (but can extend to approximately double that)

Width 2,5 cm. - white color - 25 plastic pegs included for fixing

## NUOVI PRODOTTI - NEW PRODUCTS



- Art. MBLT** MINI BAND LIGHT in poliestere ø cm.20,70 h.mm.50  
**Art. MBME** MINI BAND MEDIUM in poliestere ø cm.18,80 h.mm.50  
**Art. MBST** MINI BAND STRONG in poliestere ø cm.19,10 h.mm.50  
**Art. MBEX** MINI BAND EXTRA STRONG in poliestere ø cm.19,10 h.mm.54  
 Polyester Mini Bands

pag. 81

- Art. ELAC** Fascia elastica ad anello in tessuto extra strong circonferenza cm. 400 - h. cm.5 pensata per l'allenamento multidirezionale consente lo sviluppo di forza, esplosività, velocità, agilità e salto  
 Elastic extra strong fabric loop band circumference 400 cm. - h. 5 cm. designed for multidirectional training allows the improvement of strength, explosiveness, speed, agility and jumping

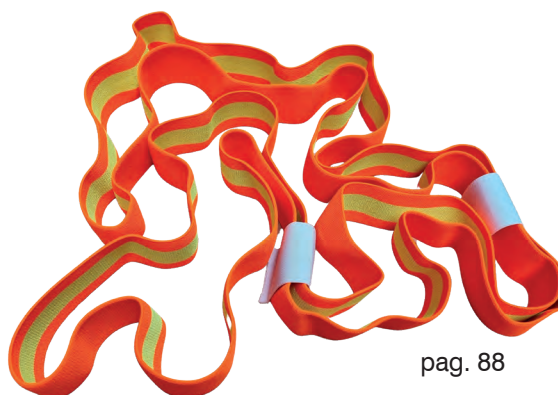

pag. 88



- Art. V6293 / V6294**  
**Panchina allenatori trasportabile su ruote lunghezza metri 3 profilo curvato mm.50x30 in lega di alluminio - altezza utile cm.210 copertura in policarbonato alveolare mm.4 oppure in policarbonato trasparente mm.3 sedute su 2 file (11 posti in totale)**  
 Transportable dug-out on wheels length 3 meters, aluminium alloy frame 50x30 mm. height 210 cm. 4 mm. non transparent polycarbonate cover or 3 mm. transparent polycarbonate cover, seating in 2 rows (11 seats in total)

pag. 159



- Art. PBRCK** SET 2 RACCHETTE Pickleball, 6 palline, custodia  
**Art. PBPLI** SET 6 PALLINE Pickleball indoor 26 fori  
**Art. PBPLO** SET 6 PALLINE Pickleball outdoor 40 fori  
**Art. PBSET** SET Pickleball con rete portatile, 4 racchette, 6 palline, set righe campo, custodie

pag. 203

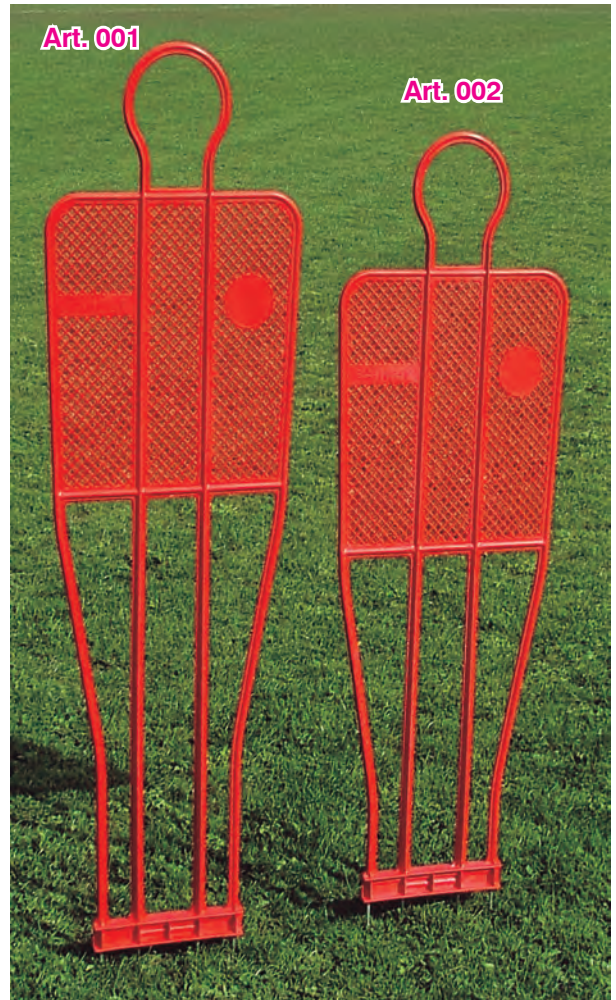
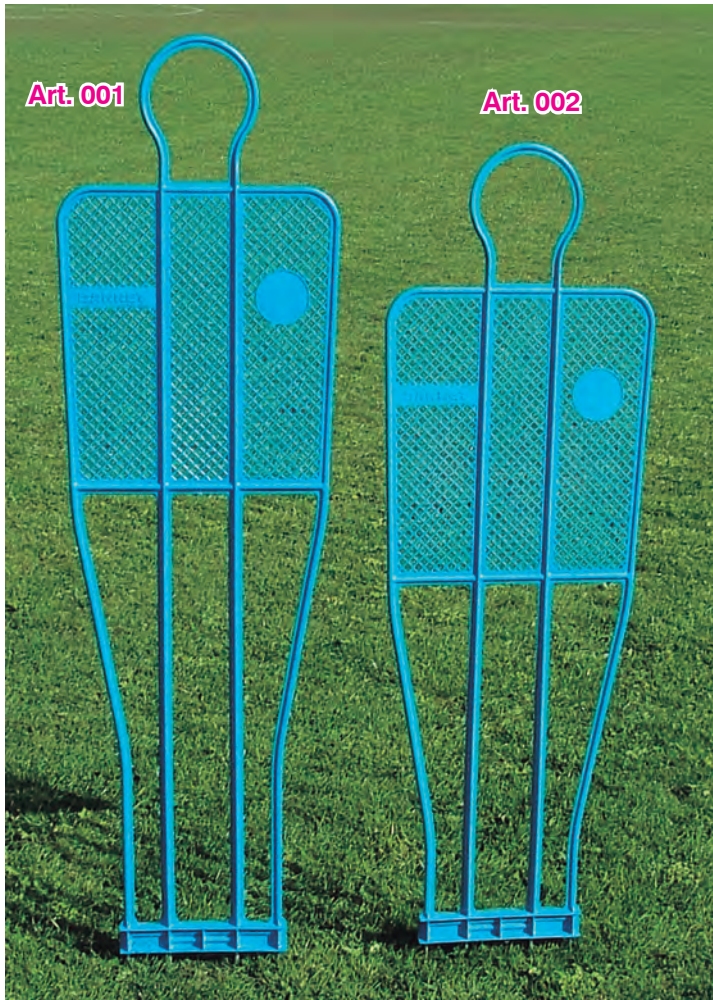

pg.1

**NUOVO MATERIALE PIÙ FLESSIBILE  
NEW MORE ELASTIC PLASTIC MATERIAL**



**Art. 001**  
**Sagoma Barret brevettata**  
**cm. 180 Kg. 3,5**  
Patented Barret Mannequin  
cm. 180 Kg. 3,5

**Art. 002**  
**Sagoma Barret brevettata**  
**cm. 160 Kg. 3**  
Patented Barret Mannequin  
cm. 160 Kg. 3

Colori:  
Rosso, Blu e Giallo  
Colors:  
Red, Blue and Yellow

**SAGOME BARRET BREVETTATE**  
leggere, flessibili, super-resistenti,  
antinfortunistiche!

**PATENTED BARRET MANNEQUINS**  
light, flexible, strong, safe!

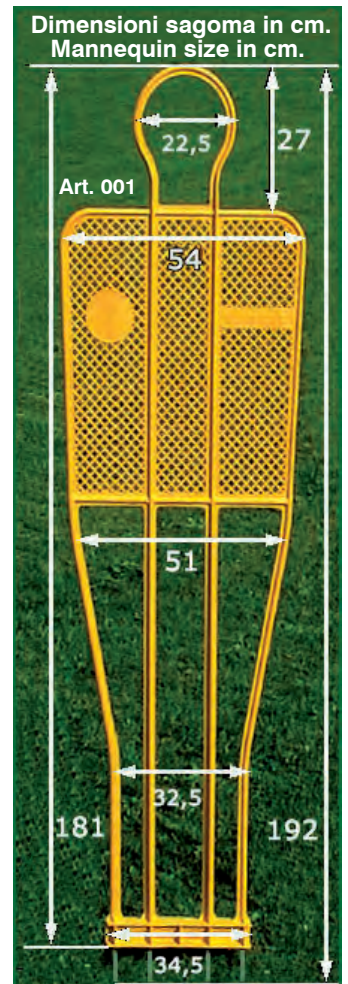

## SAGOME E BARRIERE - Barriers



**Art. 003** Carrello porta 5 sagome in acciaio zincato con ruote  
Trolley for carrying 5 mannequins in galvanized steel, with wheels



pg.1

**4 puntali in acciaio zincato alla base  
per posizionamento su  
terreno naturale  
o su carrello porta sagome**  
4 galvanized steel spikes at the base,  
for easy positioning on natural grass  
or upon Barret trolley

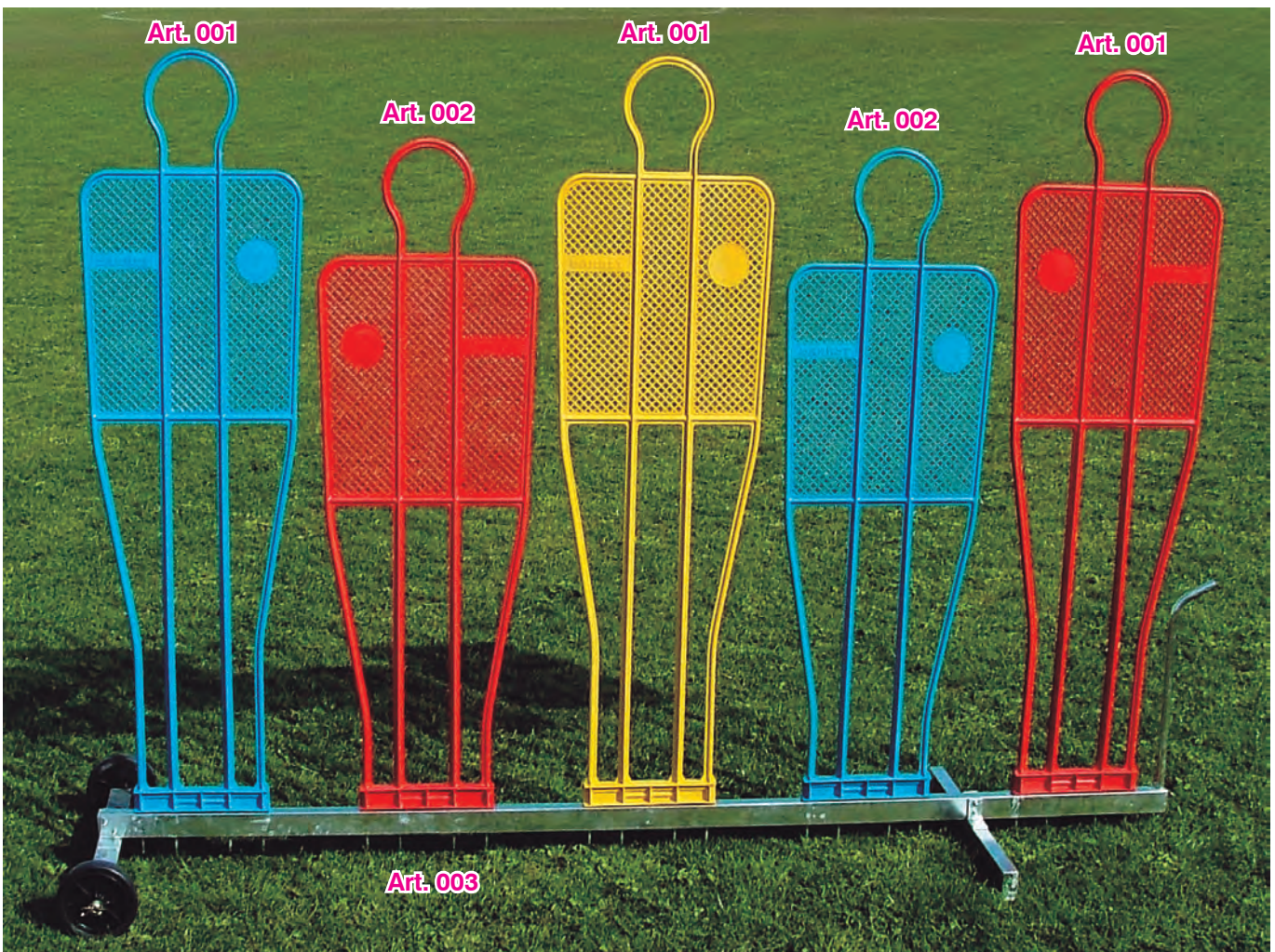

**3 x Art. 001 + 2 x Art. 002 + Art. 003**



**Art. NCP3S**  
**Carrello porta 3 sagome in acciaio zincato con ruote**  
Trolley for carrying 3 mannequins in galvanized steel, with wheels



**3 x Art. 001 + Art. NCP3S**

Video dimostrativo disponibile su [www.barretsport.com](http://www.barretsport.com)  
Video available on [www.barretsport.com](http://www.barretsport.com)

● pg.1



Il carrello regolabile in altezza permette di simulare la presenza di giocatori in barriera che saltano al momento del calcio di punizione

This trolley allows free kick practicing by simulating jumping defenders

**3 x Art. 001 + 2 x Art. 002 + Art. 003RG**

**Art. 003RG**

**Carrello porta 5 sagome in acciaio zincato con ruote - regolabile a 4 altezze (la sagoma Art. 001 può arrivare ad un'altezza massima da terra di cm.225)**  
Trolley for carrying 5 mannequins in galvanized steel, with wheels - 4 adjustable heights (Art. 001 can reach up to 225 cm. height)

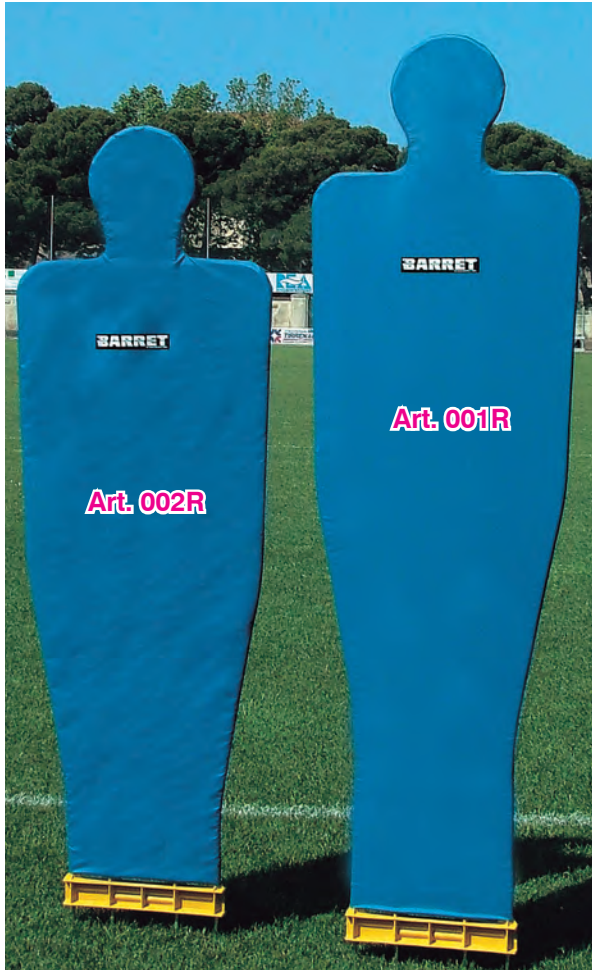

**Art. 001R**  
 Rivestimento per  
 sagoma cm. 180  
 in nylon impermeabile  
 antistrappo con cerniera  
**Colori: rosso, blu, giallo**  
 Nylon Cover for cm. 180  
 mannequin with zip  
 Colors: red, blue, yellow

**Art. 002R**  
 Rivestimento per sagoma  
 cm. 160 in nylon impermeabile  
 antistrappo con cerniera  
**Colori: rosso, blu, giallo**  
 Nylon Cover for cm. 160  
 mannequin with zip  
 Colors: red, blue, yellow



5 x Art. 001 + 5 x Art. 001R

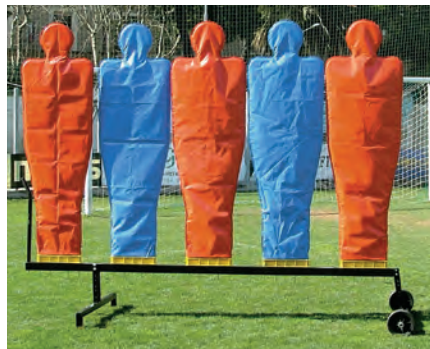

5 x Art. 001 + 5 x Art. 001R  
 + Art. 003RG

pg.1



**Art. BPS001**  
 Borsa porta 5 sagome in nylon  
 impermeabile con tracolla e  
 maniglie, rinforzi laterali  
 in polipropilene rigido  
 Nylon carrying bag for 5  
 mannequins with shoulder belt  
 and handles, waterproof,  
 reinforced on both sides

pg.1

**SAGOME BARRET BREVETTATE**  
 indispensabili per:  
*calci di punizione, slalom, dribbling,  
 esercizi di anticipo, uscite aeree,  
 schemi tattici ...*

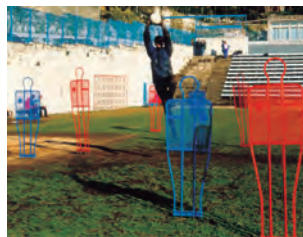

**PATENTED BARRET MANNEQUINS**  
 very useful for:  
*free kicks, slalom, dribbling, tackles,  
 headers, goalkeeper exercises, tactics ...*





**Art. 001  
+ Art. 003S**

**Art. 003S Carrello porta sagoma in acciaio zincato con ruote, con molle antibaltamento**  
Trolley for single mannequin in galvanized steel with springs, on wheels

pg.1

**Grazie alle molle il carrello Art. 003S impedisce alla sagoma di cadere a terra se colpita dalla palla**  
Thanks to the springs trolley Art. 003S allows mannequin to come back straight up when hit by the ball



**Art. 003S**

**Art. 001B**  
Base per sagoma zavorrabile in acciaio zincato, per posizionamento su terreni sintetici  
Peso: kg. 10 vuota, kg. 20 riempita con sabbia

Galvanized steel base to be filled with sand for mannequin positioning on artificial grass  
Weight: 10 kg. empty  
20 kg. filled with sand



**Art. 001B**



**Art. 001  
+ Art. 001B**

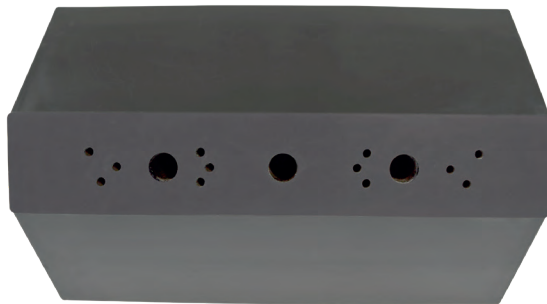

**Art. SF3454**

**Base zavorrata in caucciù per posizionamento sagoma su terreni sintetici - peso kg. 13**

Rubber base for mannequin positioning on artificial grass - weight 13 kg.

pg.1

**Art. 001  
+ Art. SF3454**







Art. 001FE

**Art. 001FE**  
**Sagoma Barret**  
**in acciaio zincato**  
**con 4 puntali**  
**altezza cm.180**  
**peso kg.5**  
 Barret mannequin  
 180 cm. height  
 in galvanized steel  
 with 4 spikes  
 weight 5 Kg.



Art. 001FE  
 + Art. 001B

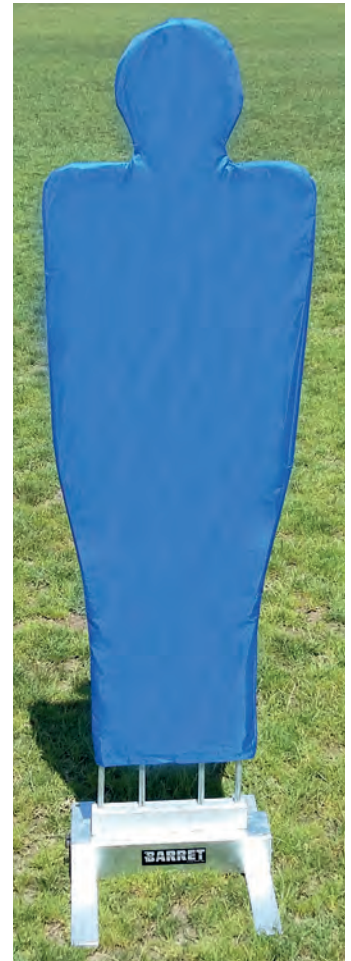

Art. 001FE  
 + Art. 001R  
 + Art. 001B

pg.1



Art. 002FE

**Sagoma Barret in acciaio**  
**zincato con 4 puntali**  
**altezza cm.160**  
**peso kg.4,5**

Barret mannequin  
 160 cm.  
 height in galvanized steel with  
 4 spikes weight 4,5 Kg.



3 x Art. 001FE + 2 x Art. 001R  
 2 x Art. 002FE + 2 x Art. 002R  
 + Art. 003



**Art. 001TD Rivestimento tridimensionale per sagoma Art. 001**  
h. cm. 180 spessore cm. 20  
in PVC bispalmato 600 gr/mq  
imbottitura in gommapiuma d. 16 kg/mc  
3D Cover 20 cm. thick  
for mannequin Art. 001  
180 cm. height

**I rivestimenti tridimensionali simulano perfettamente il volume del corpo dei giocatori permettendo una serie di esercizi tecnici e tattici con e senza palla ancora più realistici e sicuri. L'imbottitura è inoltre utile per proteggere la sagoma dagli urti della palla calciata ad alta velocità durante l'allenamento ai calci piazzati di potenza**



**3D Covers perfectly resemble players' bodies allowing even more realistic and safe technical and tactical exercises with and without ball.**

**The soft sandwich protections also avoid possible damages caused by high power free kick practising**



pg.1

**Art. 002TD Rivestimento tridimensionale per sagoma Art. 002**  
h. cm. 160  
spessore cm. 20  
in PVC bispalmato  
600 gr/mq  
imbottitura in gommapiuma  
d. 16 kg/mc  
3D Cover 20 cm. thick  
for mannequin Art. 002  
160 cm. height



**Art. GP170**

Sagoma in gommapiuma  
h. cm. 170 - rivestimento in PVC  
con decorazione digitale  
fronte-retro del giocatore,  
zavorrata alla base con sabbia  
con maniglie per il trasporto  
colori disponibili: rosso, blu,  
giallo, arancio, bianco  
Ø base cm. 59 - peso kg. 31  
Foam rubber Dummy  
170 cm. height with PVC Cover  
with player's sketch  
weighted base with sand  
with handles  
available colors: red, blue,  
yellow, orange, white  
base Ø 59 cm. - weight 31 kg.

**Nessun problema di  
forature, perdite d'aria  
o lacerazioni**  
No problems with  
punctures, deflation or  
lacerations

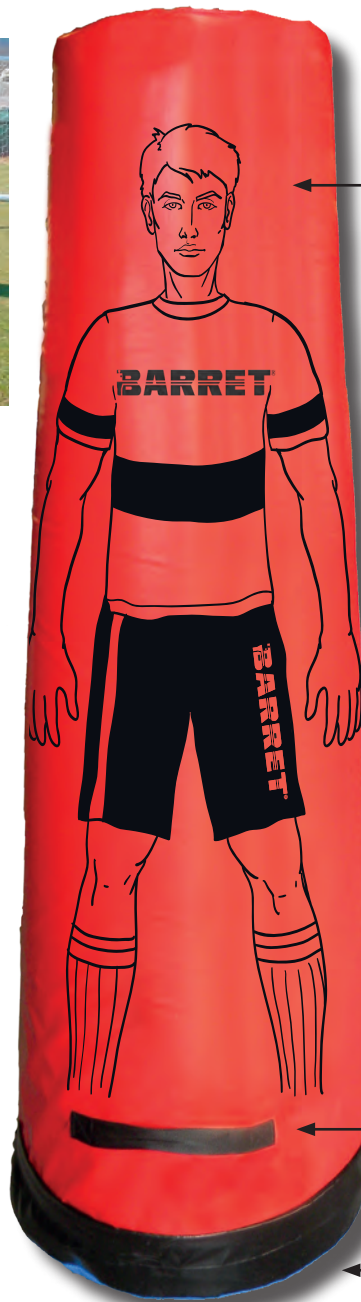

← **Rivestimento in PVC**  
PVC Cover outside

← **Imbottitura in  
poliuretano espanso**  
Foam rubber inside

pg.1

**Art. GP205**

Sagoma in gommapiuma  
h. cm. 205 - rivestimento in PVC  
con decorazione digitale  
fronte-retro del giocatore,  
zavorrata alla base con sabbia  
con maniglie per il trasporto  
colori disponibili: rosso, blu,  
giallo, arancio, bianco  
Ø base cm. 59 - peso kg. 32  
Foam rubber Dummy  
205 cm. height with PVC Cover  
with player's sketch  
weighted base with sand  
with handles  
available colors: red, blue,  
yellow, orange, white  
base Ø 59 cm. - weight 32 kg.

← **Maniglia  
su entrambi i lati**  
Handle on both  
sides

← **Base zavorrata**  
Weighted base

**Art. GP170SL**  
Sagoma in  
gommapiuma  
come Art. GP170  
solo con logo  
BARRET (senza  
la decorazione  
del giocatore)  
Foam rubber  
Dummy same of  
Art. GP170  
only with BARRET  
logo (without  
player's sketch)



**Art. GP205SL**  
Sagoma in  
gommapiuma  
come Art. GP205  
solo con logo  
BARRET (senza  
la decorazione  
del giocatore)  
Foam rubber  
Dummy same of  
Art. GP205  
only with BARRET  
logo (without  
player's sketch)

pg.1

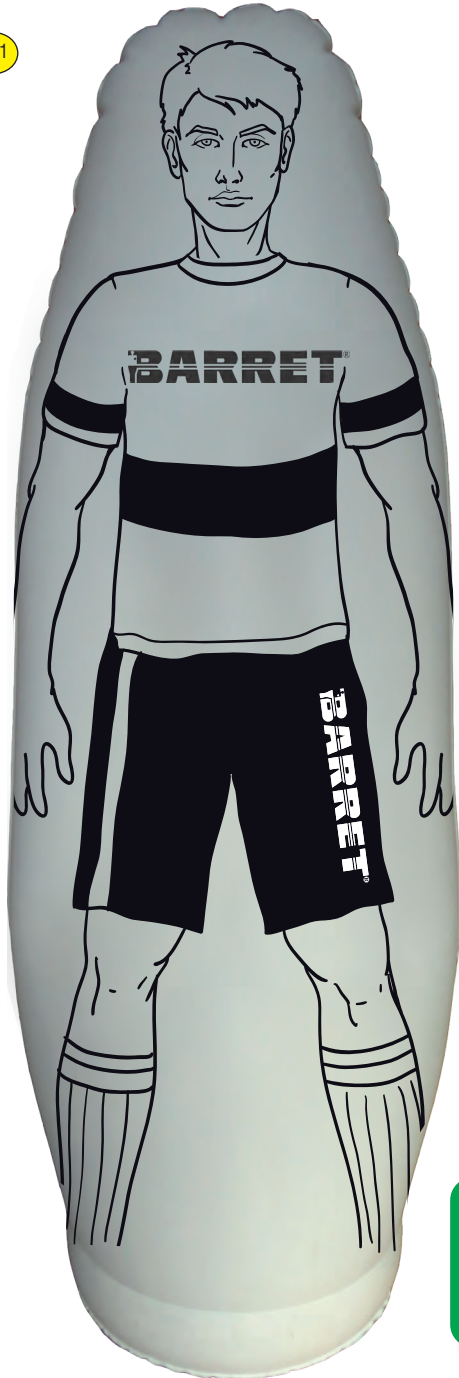

**SEMPRE IN PIEDI  
POP UP DUMMIES**

pg.1

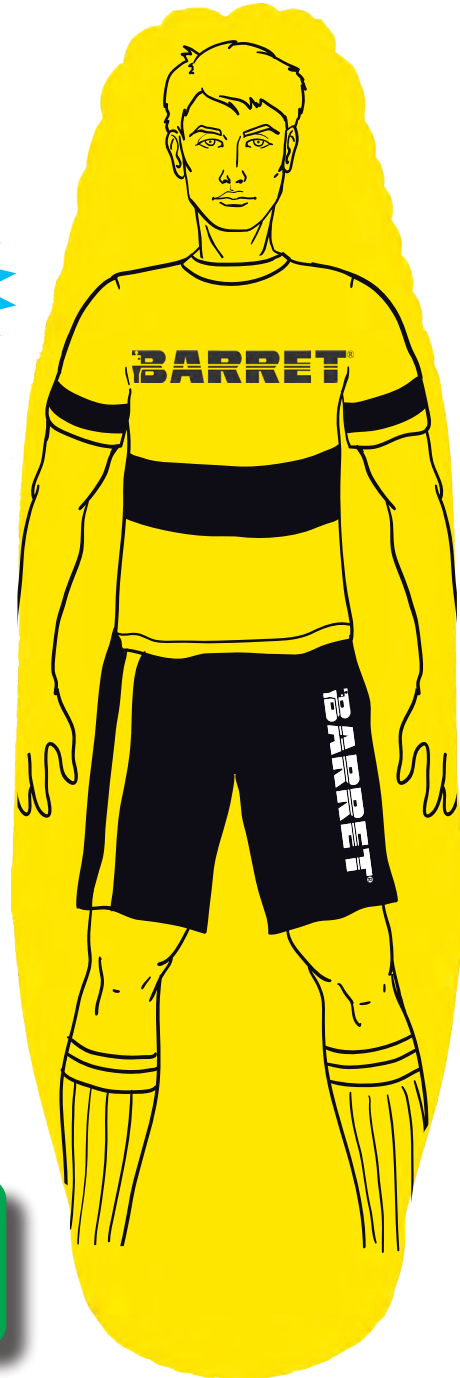

**Video dimostrativo  
disponibile su  
[www.barretsport.com](http://www.barretsport.com)  
Video available on  
[www.barretsport.com](http://www.barretsport.com)**

**Art. SAG205**

**Sagoma Gonfiabile**

**in PVC/PU h. cm.205 colore bianco**

Inflatable dummy 205 cm. height white color

**Ø base cm. 56 - peso kg. 23 (pronta all'uso)**

base Ø 56 cm. - weight 23 Kg.

(when ready for use)

**Se colpite dalla palla o dal corpo dei giocatori durante gli esercizi, le sagome gonfiabili Barret tornano in piedi da sole**

Barret inflatable dummies always pop back up when hit by ball or players' body during exercises

**Nate per l'allenamento dei portieri, le sagome gonfiabili Barret possono essere utilizzate anche per i calciatori per l'effettuazione di una molteplicità di esercizi tecnici e tattici con e senza palla**

Born for GK training, Barret inflatable dummies are very useful for lots of tactical and technical exercises involving players with and without ball

**Art. SAG205YW**

**Sagoma Gonfiabile**

**in PVC/PU h. cm.205 colore giallo**

Inflatable dummy 205 cm. height yellow color

**Ø base cm. 56 - peso kg. 23 (pronta all'uso)**

base Ø 56 cm. - weight 23 Kg.

(when ready for use)

**Particolare della valvola superiore (rientrante) da utilizzare per la gonfiatura della sagoma e della valvola inferiore (anch'essa rientrante) da utilizzare per il riempimento della base di appoggio a terra con acqua**

The upper valve to inflate the body with air, the bottom valve to fill the base with water



Video dimostrativo  
disponibile su  
[www.barretsport.com](http://www.barretsport.com)  
Video available on  
[www.barretsport.com](http://www.barretsport.com)



Ideale per i bambini  
delle scuole calcio  
Best for soccer school kids

**SEMPRE IN PIEDI**  
**POP UP DUMMIES**



pg.1

**Art. SAG175**  
**Sagoma Gonfiabile**  
**in PVC/PU h. cm.175**  
Inflatable dummy 175 cm. height

**Ø base cm. 45 - peso kg. 11**  
**(pronta all'uso)**  
base Ø 45 cm. - weight 11 Kg.  
(when ready for use)

**Art. SAG115**  
**Sagoma Gonfiabile**  
**in PVC/PU h. cm.115**  
Inflatable dummy 115 cm. height

**Ø base cm. 40 - peso kg. 7**  
**(pronta all'uso)**  
base Ø 40 cm. - weight 7 Kg.  
(when ready for use)

Per un ordine minimo di 100 pezzi per misura  
le sagome gonfiabili possono essere personalizzate

Inflatable dummies can be customized:  
minimum order 100 pieces for each size

## ISTRUZIONI PER LA GONFIATURA E L'UTILIZZO DELLE SAGOME GONFIABILI

**IMPORTANTE: LA SAGOMA NON DEVE MAI ESSERE COMPLETAMENTE GONFIA. IL CORPO DEVE RIMANERE SEMPRE MORBIDO, ED I FIANCHI NON DEVONO ESSERE MARCATAMENTE SPORGENTI VERSO L'ESTERNO RISPETTO ALLA BASE**

**(UNA ECCESSIVA QUANTITÀ D'ARIA LOGORA LE SALDATURE ED ACCORCIA LA VITA DEL PRODOTTO)**

- 1) Gonfiare la sagoma **solo moderatamente**
- 2) Tenendo la sagoma distesa a terra, inserire acqua nel serbatoio: quando la sagoma comincia ad inclinarsi verso l'alto, chiudere il tappo del serbatoio e disporla in posizione verticale
- 3) Provare a spingere la sagoma lateralmente e osservare come torna in posizione eretta
- 4) Se si vuole che la sagoma si rialzi più velocemente, aggiungere dell'acqua (a discapito del peso) e gonfiare un po'
- 5) Se si gonfia ulteriormente la sagoma, distenderla a terra e fare uscire l'aria in eccesso dal serbatoio dell'acqua (il fondo deve essere piatto, non bombato)
- 6) E' importante **utilizzare la minima quantità di acqua** che permette alla sagoma di risalire nel modo desiderato (un peso eccessivo e non giustificato può logorare inutilmente le saldature, accorciando la vita del prodotto)
- 7) Una volta trovato l'equilibrio desiderato, la sagoma può essere sgonfiata e rigonfiata (ad esempio, per trasportarla in luogo lontano) senza più svuotare il serbatoio dell'acqua
- 8) Non utilizzare le sagome se la temperatura è più bassa di 5 °C (e in ogni caso non usarle se l'acqua nel serbatoio è ghiacciata)
- 9) Non colpire le sagome con corpi appuntiti, non avvicinarle a fonti di calore, non trascinarle ma sollevarle sempre con le maniglie quando occorre spostarle, non sbatterle violentemente a terra, non lasciarle esposte al sole per giorni
- 10) Per le riparazioni utilizzare l'apposito kit o Loctite 406 (altri prodotti non hanno efficacia sul materiale) Il prodotto è garantito solo per un utilizzo diligente che rispetti le istruzioni fornite



**Art. KSG**  
Kit di riparazione  
(collante +  
3 porzioni di  
rivestimento)  
Inflatable dummy  
repairing kit



**SEMPRE IN PIEDI  
POP UP DUMMIES**



### USER'S INSTRUCTIONS

**IMPORTANT: YOU ALWAYS HAVE TO KEEP THE BODY OF YOUR DUMMY VERY SOFT (NOT FULLY INFLATED) AND HIPS HAVE TO BE IN A STRAIGHT LINE WITH THE BASE (THEY MUST NOT BE ROUNDED)**

**(AN EXCESSIVE AMOUNT OF AIR WILL WEAR OUT THE WELDS AND SHORTEN THE TOOL'S LIFE)**

Inflatable dummies are entirely made of soft PVC/PU: there are no rigid parts, so these products are absolutely safe. First, you have to inflate your dummy but **not completely**. Then, by keeping it lying on the floor, you have to put some water in the tank: when the dummy rises up, close the valve and place it upright.

If you want your dummy to rise up more quickly when hit, add some water and inflate the body a little more. In this case, let the dummy lie on the floor for a while and let some air out from the tank (the base must be flat, not rounded). It's important you **to use the minimum amount of water** that allows your dummy to rise the desired way (an excessive and unjustified weight will wear out the welds, shortening the tool's life).

Once the desired balance has been found, the dummy can be deflated and re-inflated without emptying the water tank (for example, when you need to transport it to a distant place).

Dummies can be used both on natural and artificial grass, on turf, gym floors etc.

Two side handles made of soft PVC are very useful to carry your dummy around: it is important to always lift your dummy when you need to move it (never pull it!) so the base doesn't get damaged.

Do not use dummies if the temperature is lower than 5 °C (and in any case do not use them if the water in the tank is frozen).

It is also available a kit for repair when inflatable dummies get damaged because used in wrong ways, in example when they are torn apart by players kicking with their studs against them.



pg.1

**Art. 706244**  
**Sagoma in plastica rinforzata antiurto su carrello a 4 ruote**  
**altezza cm.190**  
**peso totale Kg.22**  
**(kg.7 la sagoma - Kg.15 il carrello)**  
**spessore sagoma cm.9**  
 Mannequin in reinforced plastic 9 cm. thick with 4 wheel trolley height 190 cm. weight 22 Kg.

**LATO ANTERIORE**  
**FRONT**

**LATO POSTERIORE**  
**BACK**

pg.1

**Art. 5026**  
**Sagoma Barret**  
**in vetroresina**  
**h. cm. 185**  
 Barret  
 fiberglass  
 Mannequin  
 185 cm. height

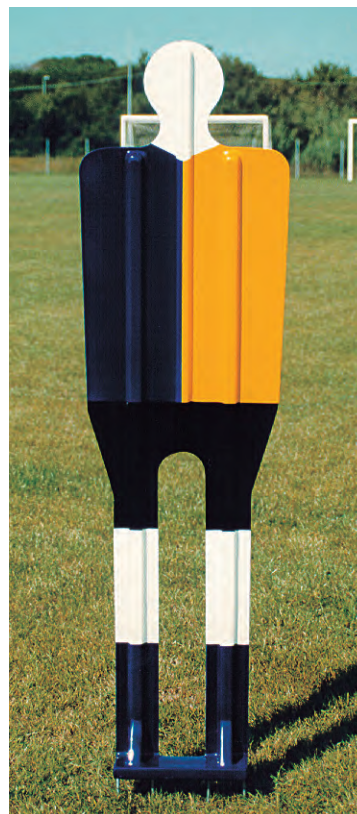

**Indistruttibili!**  
**Unbreakable!**

**4 puntali in acciaio zincato alla base, per posizionamento su terreno naturale o su carrello portasagome**

4 galvanized steel spikes at the base, for quick positioning on natural grass or on trolley

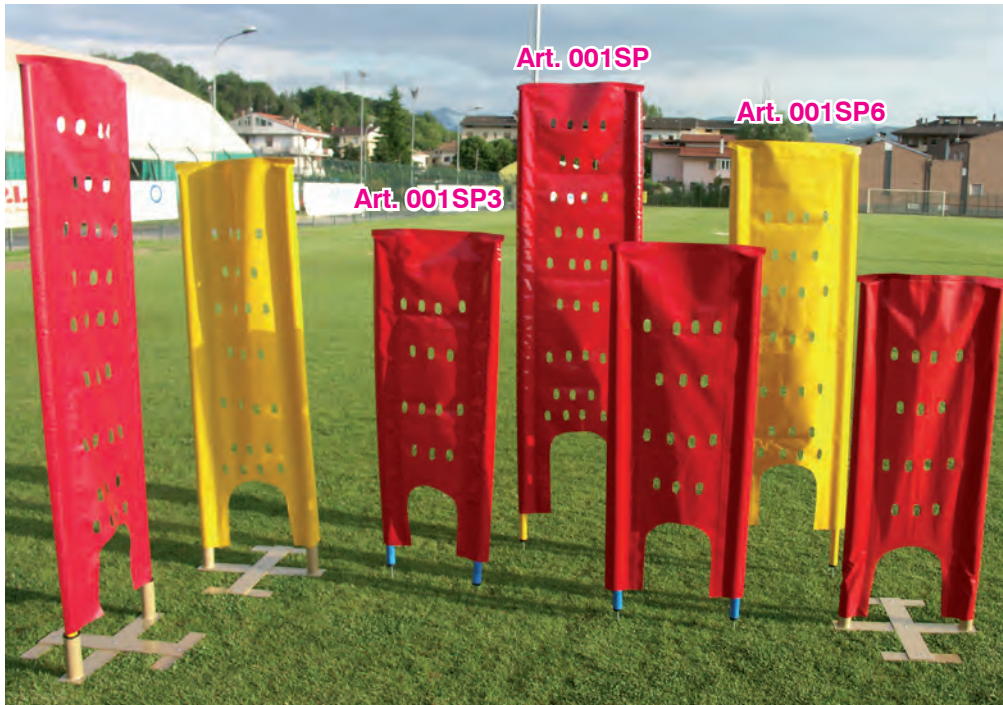

**Art. 001SP**  
**Sagoma soft con telo PVC forato antivento su 2 paletti in PVC h. cm. 170 con puntale**  
 Soft pierced antiwind PVC Mannequin on 2 PVC poles 170 cm. high with metal spike

**Art. 001SP3**  
**Sagoma soft con telo PVC forato antivento su 2 paletti in PVC h. cm. 130 con puntale**  
 Soft pierced antiwind PVC Mannequin on 2 PVC poles 130 cm. high with metal spike

**Art. 001SPA**  
**Sagoma soft con telo PVC forato antivento su 2 paletti in alluminio h. cm. 170 con puntale**  
 Soft pierced antiwind PVC Mannequin on 2 aluminium poles 170 cm. high with metal spike

**Art. 001SP6**  
**Sagoma soft con telo PVC forato antivento su 2 paletti in PVC h. cm. 160 con puntale**  
 Soft pierced antiwind PVC Mannequin on 2 PVC poles 160 cm. high with metal spike

● pg.1



**Art. SA001**  
**Supporto per sagoma soft in ferro verniciato utilizzabile su terreno sintetico**  
 Base in painted iron for positioning any soft mannequin on artificial grass

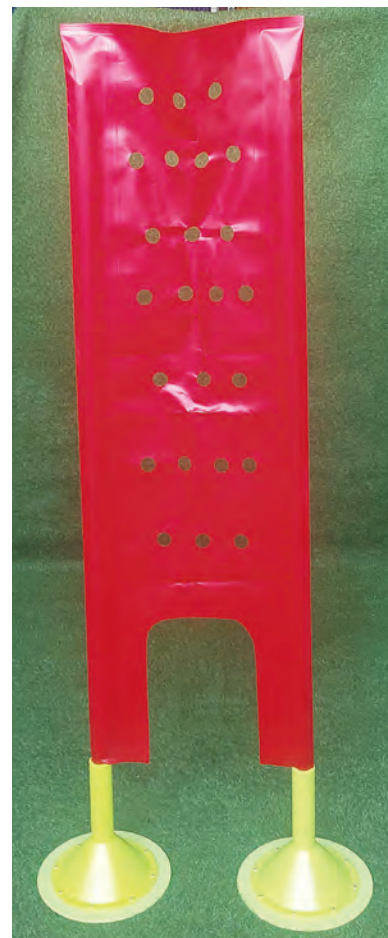

**Art. BA001SP**  
**Sagoma soft con telo in PVC h. cm.183 su 2 paletti in PVC senza puntale e 2 basi Art. SP202**  
 Soft pierced antiwind PVC Mannequin 183 cm. height on 2 PVC poles and 2 bases Art. SP202

**Art. BA001SPA**  
**Sagoma soft con telo in PVC h. cm.183 su 2 paletti in alluminio senza puntale e 2 basi Art. SP202**  
 Soft pierced antiwind PVC Mannequin 183 cm. height on 2 aluminium poles and 2 bases Art. SP202



## PALETTI SLALOM - Slalom Poles



**Art. 007**  
Paletto cm. 170  
in PVC Ø mm. 32  
con puntale zincato  
colore giallo, giallo fluo,  
rosso, bianco, blu, arancio  
Pole 170 cm. high  
in PVC with  
galvanized metal spike  
colors: yellow, fluo yellow,  
red, white, blue, orange



**Art. 007SP**  
Paletto senza puntale  
cm. 162  
in PVC Ø mm. 32  
colore giallo fluo,  
rosso, bianco, blu  
Pole 162 cm. high  
in PVC  
colors: fluo yellow,  
red, white, blue

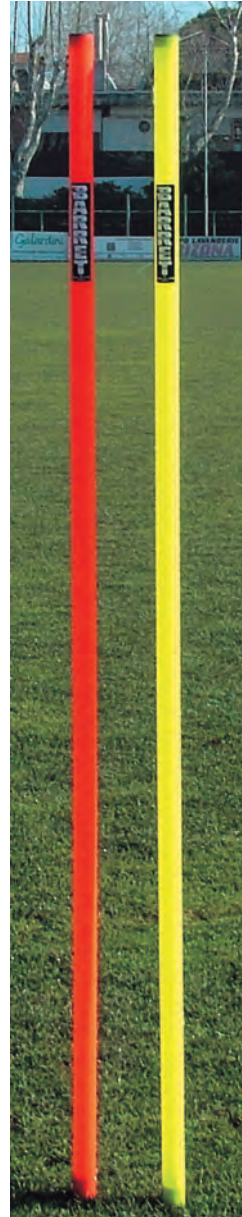

pg.2



**Art. 007F**  
Paletto in polipropilene  
copolimero Ø 32 mm.  
h.cm.163  
con puntale zincato,  
colore giallo fluorescente  
o arancio fluorescente  
Pole 163 cm. height in  
copolymer polypropylene  
32 mm. with galvanized metal  
spike - colors: fluorescent  
yellow and fluorescent orange



**Art. P007**  
Paletto cm. 160  
in polipropilene  
Ø mm. 30 con  
puntale e piattello  
di appoggio,  
colore giallo fluo  
Pole 160 cm. h.  
in polypropylene  
metal spike  
with ring  
color fluo yellow

**Art. BFT**  
Borsa porta paletti  
(capienza massima  
30 pezzi)  
Bag containing  
up to 30 poles  
(poles not included)





pg.2



**Art. A007**  
Paletto cm. 170  
in alluminio Ø mm. 32  
con puntale zincato  
Pole 170 cm. high  
in aluminium with  
galvanized metal spike

**Art. S007**  
Paletto flessibile  
cm. 170 in  
PVC Ø mm. 32 con  
puntale  
zincato e molla,  
colore giallo o rosso  
Pole 170 cm. h.  
in PVC with  
galvanized metal  
spike and spring  
colors: yellow, red



**Art. AS007**  
Paletto flessibile  
cm. 170 in  
alluminio Ø mm.  
32 con puntale  
zincato e molla  
Pole 170 cm. h.  
in aluminium with  
galvanized metal  
spike and spring



cm. 170



cm. 90



**Art. 007TL**  
Paletto telescopico  
Ø 32 mm  
h. cm. 170 in PVC  
con puntale zincato  
(l'altezza si riduce  
fino a cm.90)  
colore giallo  
Telescopic Pole h. 170  
cm. in PVC with galvanized  
metal spike  
Height can be reduced  
down to 90 cm.  
color yellow



pg.2

**Art. 007.25**  
Paletto  
cm. 170  
smontabile  
in PVC  
Ø 25 mm  
con puntale  
zincato svitabile  
colore giallo  
Dismountable  
Pole 170 cm.  
height in PVC  
with removable  
galvanized metal  
spike  
color yellow





**Art. 018**

Base ad imbuto  
in plastica per  
paletto Ø 32 mm  
con o senza puntale  
Funnel-shaped plastic base for  
pole with or without metal spike



**Art. 902013**

Base cilindrica in plastica  
riempibile con sabbia o  
acqua, solo per paletto  
Ø 32 mm senza puntale  
Cylindrical plastic base to  
be filled with sand or water,  
only for pole without  
metal spike

pg.2



**Art. HWRB**

Base in gomma  
appesantita  
per paletto Ø 32 mm  
con o senza puntale  
Weighted Rubber base  
for pole with  
or without metal spike



**Art. SP202** Base ad imbuto  
in plastica riempibile con  
sabbia, solo per paletto  
Ø 32 mm senza puntale  
Funnel-shaped plastic base  
to be filled with sand, only for  
pole without metal spike



h. cm. 173

**Art. 010**  
Kit paletto PVC  
Ø 32 mm  
senza puntale  
Art. 007SP  
+ base Art. 018  
Kit pole without  
metal spike  
+ base Art. 018



h. cm. 170

**Art. 010C**  
Kit paletto PVC  
Ø 32 mm  
senza puntale  
Art. 007SP  
+ base Art. 902013  
Kit pole without  
metal spike  
+ base Art. 902013

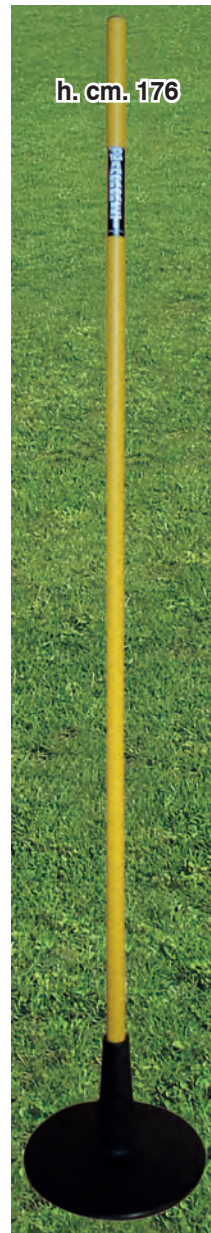

h. cm. 176

**Art. 010WR**  
Kit paletto PVC  
Ø 32 mm  
senza puntale  
Art. 007SP  
+ base Art. HWRB  
Kit pole without  
metal spike  
+ base Art. HWRB

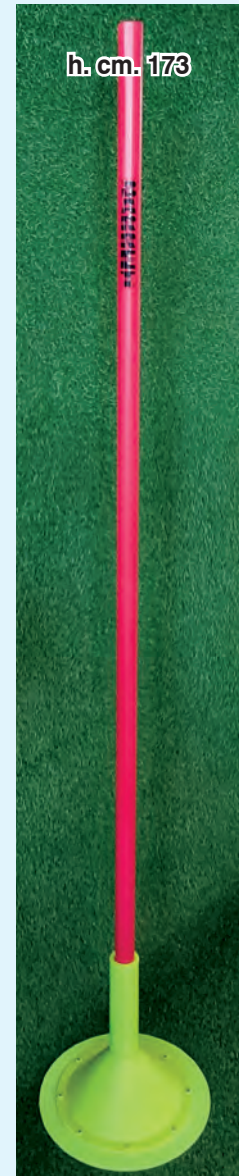

h. cm. 173

**Art. S111P** Kit paletto PVC  
Ø 32 mm senza puntale  
Art. 007SP  
+ base Art. SP202  
Kit pole without metal spike  
+ base Art. SP202



**Art. TAH-X**

**Base riempibile con sabbia per aste Ø 25 mm. e cerchi piatti o tubolari  
colori: giallo, blu e rosso**

Base to be filled with sand for poles Ø 25 mm. and flat or tubular hoops  
colors: yellow, blue and red



**Art. TAH25**

**KIT ASTA in PVC Art. SP25  
+ BASE riempibile Art. TAH-X**  
Kit PVC pole Art. SP25  
+ Base Art. TAH-X



pg.2

**Art. SP25**

**Asta in PVC Ø 25 mm.  
altezza cm. 152  
colori: giallo, blu e rosso**  
PVC pole Ø 25 mm.  
height 152 cm.  
colors: yellow, blue and red

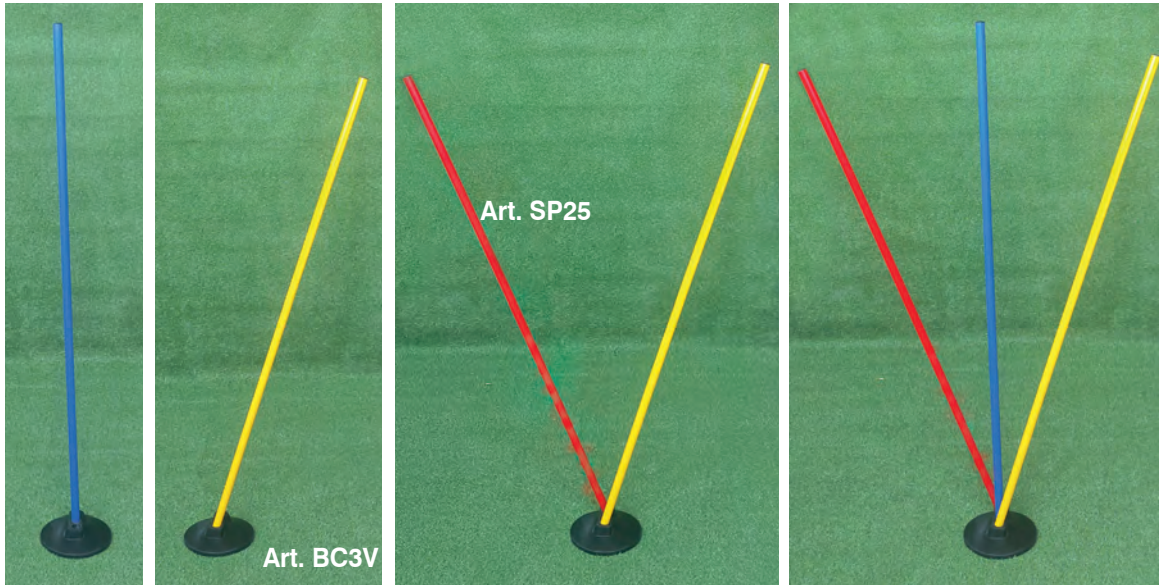

pg.2

**Art. BC3V + Art. SP25**



**Art. BC3V**

**Base in gomma appesantita per inserire fino a 3 aste in PVC diam. mm.25  
con diverse angolazioni - peso Kg.1,3 diametro cm.22,5**  
Rubber weighted base to insert up to 3 PVC poles diam. 25 mm.  
with different angles - weight 1,3 Kg. diameter 22,5 cm.

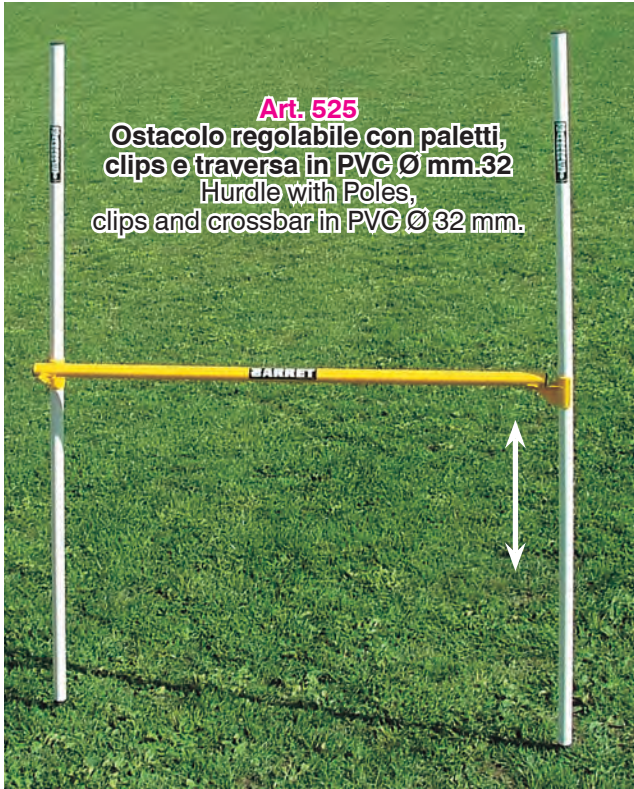

**Art. 525**  
**Ostacolo regolabile con paletti, clips e traversa in PVC Ø mm.32**  
 Hurdle with Poles, clips and crossbar in PVC Ø 32 mm.

pg.2



**Art. 5025**  
**Ostacolo regolabile con paletti graduati, clips e traversa in PVC Ø mm.32**  
 Hurdle with Graded Poles, clips and crossbar in PVC Ø 32 mm

h. cm. 10 → 160



**Art. 012**  
**Traversa in PVC cm.110 Ø mm. 32**  
 Crossbar 110 cm. in PVC Ø 32 mm.



**Art. 012F**  
**Traversa in polipropilene copolimero cm. 110 Ø mm.32 giallo fluo o arancio fluo**  
 Crossbar 110 cm. in copolymer polypropylene Ø 32 mm. in fluo yellow and fluo orange

pg.3



**Art. 525F**  
**Ostacolo regolabile con paletti h. cm. 163 con puntale, 1 traversa e 2 clips in polipropilene copolimero colore giallo fluo o arancio fluo**  
 Hurdle with graded poles, clips and crossbar in copolymer polypropylene Ø 32 mm. (colors: fluo yellow and fluo orange)

pg.2

h. cm. 10 → 160



**Art. ELNR**  
**ELASTICO nero con velcro lunghezza cm.135 da fissare ai paletti come traversa ad altezza regolabile**  
 Black band length 135 cm. with velcro to be used as adjustable height crossbar

pg.3

## DELIMITATORI - Markers

**SPECIFICARE I COLORI RICHIESTI AL MOMENTO DELL'ORDINE**

**PLEASE, SPECIFY COLORS IN YOUR ORDER**



### Art. 016

**Kit 48 Delimitatori h. cm.5 con rimessaggio colori disponibili:**  
**giallo fluo, rosso, fucsia, arancio fluo, blu, bianco**  
Kit 48 Markers h. 5 cm. with holder  
(colors: fluo yellow, red, fuchsia, fluo orange, blue, white)

### Art. 016.1

**Kit 48 Delimitatori h. cm.5 senza rimessaggio**  
(come articolo 016 senza rimessaggio)  
Kit 48 Markers h. 5 cm. without holder

pg.3



**Art. 016.R5 Rimessaggio in plastica per delimitatori h. cm.5 e cm.7**  
Plastic Holder for 5 cm. and 7 cm. height markers



### Art. 016.B

**Kit 48 Delimitatori h. cm.8 con rimessaggio giallo fluo, rosso, fucsia, arancio fluo, blu, bianco**  
Kit 48 Markers 8 cm. height with holder  
(fluo yellow, red, fuchsia, fluo orange, blue, white)



### Art. 016.R

**Rimessaggio in ferro per delimitatori h. cm.8 e delimitatori giganti Art. 016.K**  
Iron Holder for 8 cm. and giant markers



### Art. 016-TDC

**Raccoglitore in plastica per delimitatori con manico allungabile**  
Adjustable length picking device for markers



### Art. 016.T



### Art. 016.T

**Kit 48 Delimitatori h. cm. 7 con rimessaggio e intagli sulla sommità**  
**colori disponibili: giallo e rosso**

Kit 48 Markers with holder 7 cm. height carved on top  
(colors: red and yellow)

**Art. OSPT15** Delimitatore circolare piatto Ø cm.15 spessore mm.1 colori giallo, rosso, arancio, bianco, celeste  
Flat round Marker Ø 15 cm. colors: red, yellow, orange, white, blue

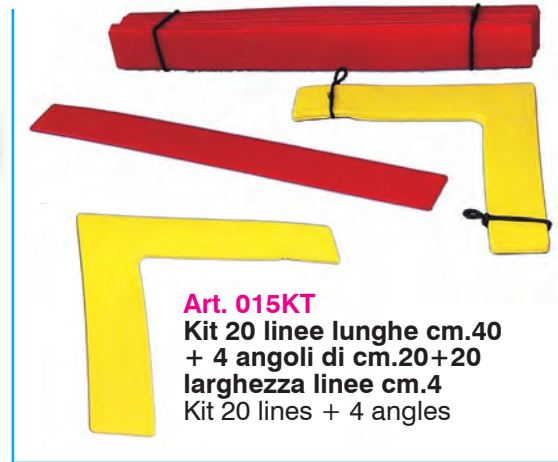
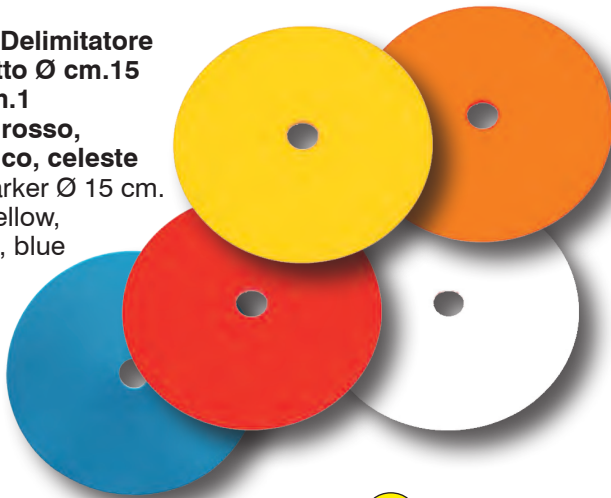

**Art. 015KT**  
Kit 20 linee lunghe cm.40 + 4 angoli di cm.20+20 larghezza linee cm.4  
Kit 20 lines + 4 angles

pg.3



**Art. 15HCR** Rimessaggio in metallo per delimitatori piatti Art. OSPT15  
Metal Holder for Art. OSPT15



**Art. DC25**  
Delimitatore circolare piatto Ø cm.25 spessore mm.1 colori giallo, rosso, arancio, bianco, blu  
Flat round Marker Ø 25 cm. colors: red, yellow, orange, white, blue



**Art. 016.K**  
Delimitatore gigante con scanalature base Ø cm. 30 h. cm.16,5 peso gr. 100 colori: giallo, arancio e bianco  
Giant Marker 16,5 cm. height carved on top and sides colors yellow, orange and white

pg.3

Con l'uso di traverse consente la creazione di ostacoli di altezza cm. 5 / 10 / 15  
Giant markers along with crossbars can create hurdles 5-10-15 cm. high



**Art. E21**



**Art. E21** Traversa cm.120 in PVC Ø mm. 25 - colori giallo, rosso, blu, verde, bianco  
Crossbar 120 cm. in PVC Ø 25 mm. - colors yellow, red, blue, green, white

## BIRILLI - Cones

**Art. 205000**  
**Birillo calpestabile**  
**in caucciù termoplastico**  
**base Ø cm. 14 - h. cm. 15**  
**colori giallo e rosso**  
 Soft Cone 15 cm. height  
 14 cm. Ø base  
 colors: red, yellow



**Art. HA7**  
**Birillo calpestabile**  
**in caucciù**  
**termoplastico**  
**base Ø cm. 17**  
**h. cm. 18**  
**colori giallo e rosso**  
 Soft Cone  
 18 cm. height and  
 17 cm. Ø base  
 colors: red, yellow

pg.3



**Art. 019.1**

**Art. 019.1**  
**Maxidelimitatore h. cm. 28**  
**fornito singolarmente**  
**colori: giallo, arancio, rosso,**  
**royal e fucsia**  
 Loose Maximarker height 28 cm.  
 colors: yellow, orange, red, blue  
 and fuchsia



**Art. 019**  
**Kit 24 Maxidelimitatori h. cm. 28**  
**colori: giallo, arancio, rosso, royal e fucsia**  
 Kit 24 Maximarkers height 28 cm.  
 colors: yellow, orange, red, blue and fuchsia



**Art. 023E**  
**Birillo economico**  
**senza fori h. cm. 30**  
**colori rosso e giallo**  
 Light Cone  
 30 cm. height  
 with no holes  
 colors: red,  
 yellow





**Art. 023N**

**Birillo h. cm. 38 colore rosso, giallo o blu - Cone height 38 cm. colors: red, yellow, blue**  
**Peso gr. 200 senza foro sulla sommità - Weight 200 gr. with no hole at top**



**Peso gr. 450  
Weight 450 gr.**

**Art. 023**

**Birillo giallo h. cm. 40 con foro sulla sommità**  
 Yellow Cone 40 cm. height with hole at the top

**Art. 025**

**Birillo fucsia h. cm. 40 con foro sulla sommità**  
 Fuchsia Cone 40 cm. height with hole at the top

**Art. 024**

**Birillo rosso h. cm. 40 con foro sulla sommità**  
 Red Cone 40 cm. height with hole at the top

● pg.3



**in 4 colori  
in 4 colors**

**Art. B312**

**Birillo a 8 fori h. cm. 30 con scanalatura sulla sommità**  
 Cone with 8 holes 30 cm. height carved on top



**Art. E21 Traversa cm.120 in PVC Ø mm. 25 colori giallo, rosso, blu, verde, bianco**

**Crossbar 120 cm. in PVC Ø 25 mm. - colors yellow, red, blue, green, white**



**Art. I-111**  
**Clip rotante**  
**per aste**  
 Ø mm. 25 e 28  
 Rotating clip  
 for two pipes  
 Ø mm. 25 and 28



**Art. C21**  
**Birillo a 16 fori**  
**h. cm. 50**  
**con scanalatura**  
**sulla sommità**  
 Cone with 16 holes  
 height 50 cm.  
 carved on top

pg.3

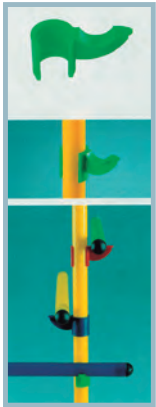

**Art. I-110**  
**Clip per montante**  
**Ø mm. 25 e 28**  
**e traversa**  
 Clip for pipe  
 Ø mm. 25 and 28  
 and crossbar

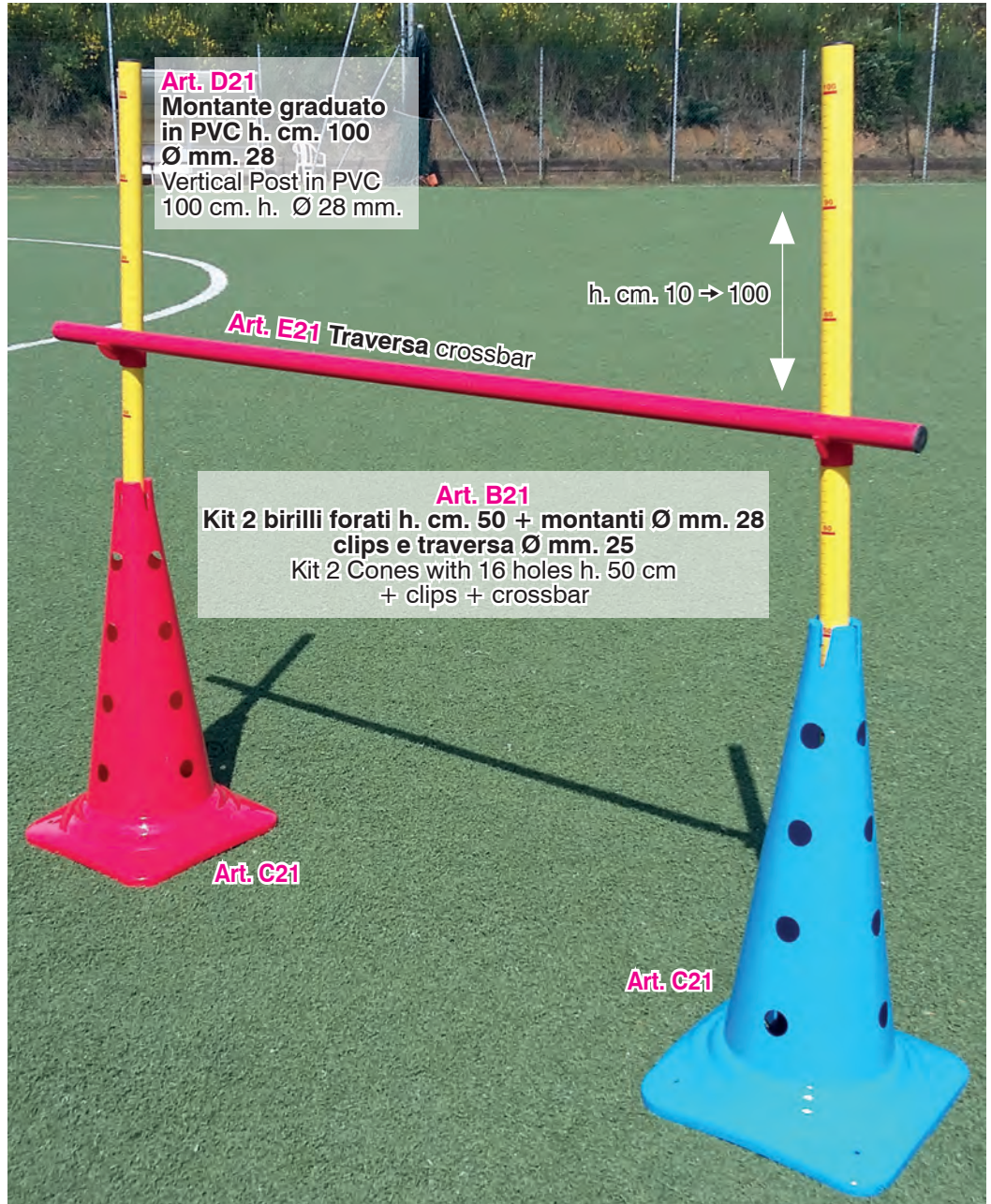

**Art. D21**  
**Montante graduato**  
**in PVC h. cm. 100**  
**Ø mm. 28**  
 Vertical Post in PVC  
 100 cm. h. Ø 28 mm.

h. cm. 10 → 100

**Art. E21** *Traversa crossbar*

**Art. B21**  
**Kit 2 birilli forati h. cm. 50 + montanti Ø mm. 28**  
**clips e traversa Ø mm. 25**  
 Kit 2 Cones with 16 holes h. 50 cm  
 + clips + crossbar

**Art. C21**

**Art. C21**



**Art. I-112**  
**Clip per asta**  
**Ø mm. 25 e 28**  
**e cerchio piatto**  
 Clip for pipe  
 Ø mm. 25 and 28  
 and flat hoop

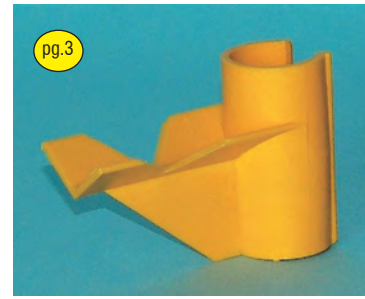

**Art. 011**  
Clip per sostegno traversa per asta Ø mm. 32 e 28  
Clip for crossbar for pipe Ø mm. 32 and 28



**Art. CL17**  
Clip rotante per aste Ø mm. 32  
Rotating clip for two pipes Ø 32 mm.

pg.2

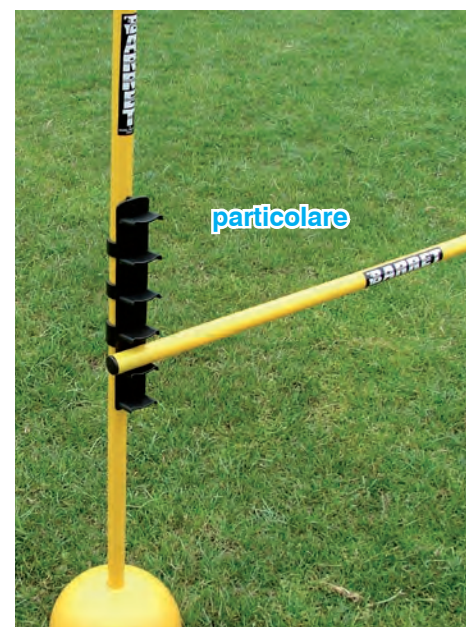

## OSTACOLI - Hurdles



pg.5

**Art. MH6 / MH9 / MH12**  
Mini-Over in PVC  
altezza fissa,  
cm. 15 / 23 / 30  
Ideali per i bambini  
delle scuole calcio

Mini-Over in PVC  
fixed height,  
15 / 23 / 30 cm.  
Best for soccer  
school kids



pg.4

Tornano in posizione  
dopo ogni urto  
senza danneggiarsi  
These hurdles come  
back in position after  
any hit without being  
damaged

**Art. 80.12 / 80.14 / 80.16 / 80.18**  
**80.20 / 80.30 / 80.40 / 80.50 / 80.60**  
Ostacolo Over in PVC  
altezza fissa,  
cm.12-14-16-18-20-30-40-50-60  
Hurdle Over in PVC  
fixed height,  
12-14-16-18-20-30-40-50-60 cm.

pg.4

**Art.**  
**P031-A / P031 / P032**  
**P033 / P034 / P035**  
Ostacolo Over  
in PVC Ø mm. 32  
altezza fissa  
disponibile  
da 12 a 60 cm.  
Hurdle Over in PVC,  
fixed height  
available  
from 12 to 60 cm.



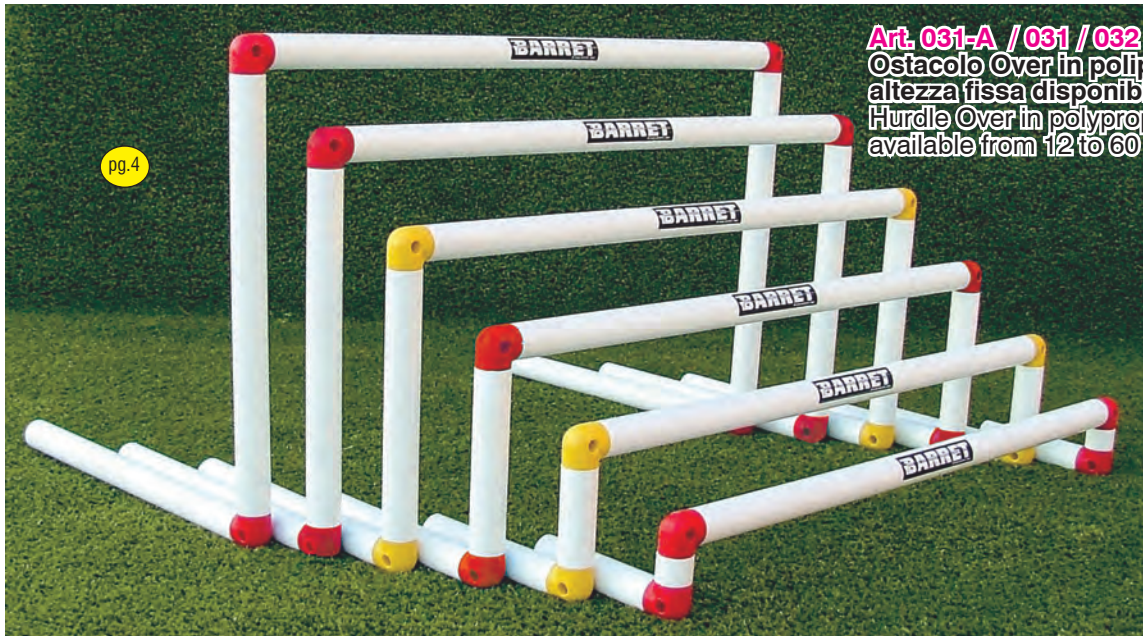

pg.4

**Art. 031-A / 031 / 032 / 033 / 034 / 035**  
Ostacolo Over in polipropilene Ø mm. 40  
altezza fissa disponibile da 12 a 60 cm.  
Hurdle Over in polypropylene, fixed height  
available from 12 to 60 cm.

**Polipropilene  
copolimero  
Ø 40 mm.  
altamente  
resistente e  
flessibile fino a  
-5 gradi!**  
Polypropylene  
copolymer  
40 mm. highly  
resistant and  
elastic till minus  
5 degrees!

pg.5



**Art. 235-1 / 235.2 / 235.3 / 235.4 / 235.5 / 235.6**  
Ostacolo Over  
in ferro verniciato altezza fissa  
disponibile da 12 a 60 cm.  
Hurdle Over in painted iron,  
fixed height available  
from 12 to 60 cm.

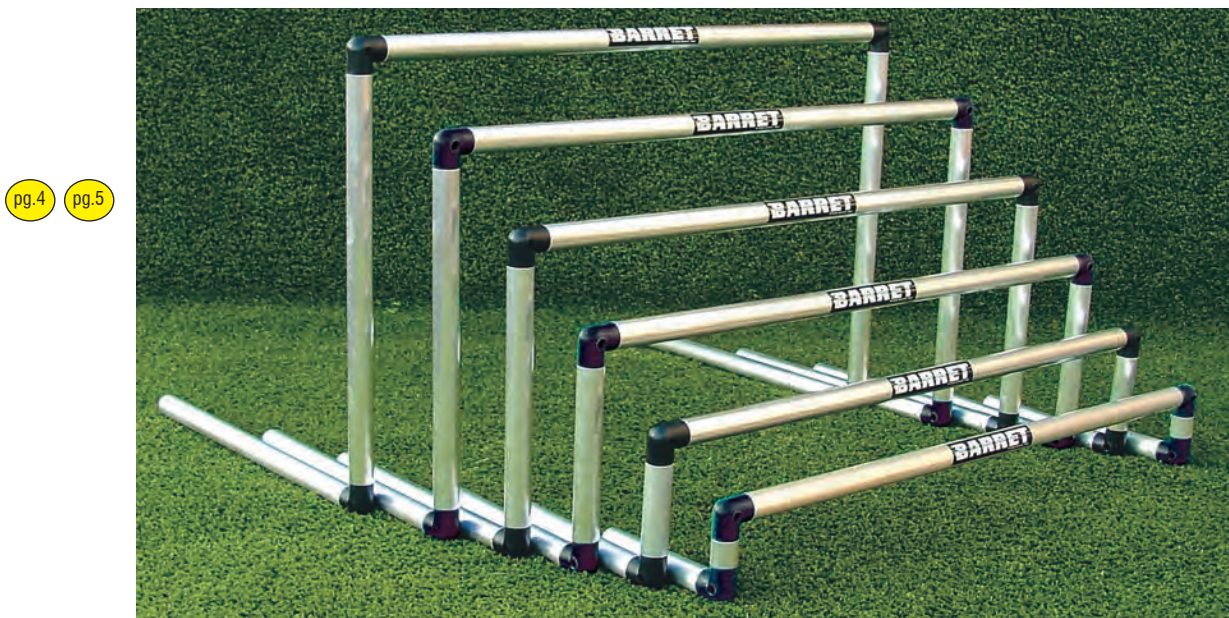

pg.4

pg.5

**Art. A031-A / A031 / A031-B / A032 / A033 / A034 / A035**  
Ostacolo Over in alluminio Ø mm. 32 altezza fissa disponibile da 12 a 60 cm.  
Hurdle Over in aluminium, fixed height available from 12 to 60 cm.



pg.5

**Art. 239TI**

**Ostacolo con traversa inclinata altezza variabile da cm. 12 a cm. 60 in ferro verniciato - larghezza mt. 2 (scomponibile) Ordinare quantità multipla di 3 pezzi**  
 Hurdle with inclined crossbar height from 12 cm. to 60 cm. in painted iron - width 2 meters (dismountable in 3 pieces) Please order multiple quantities of 3 pieces

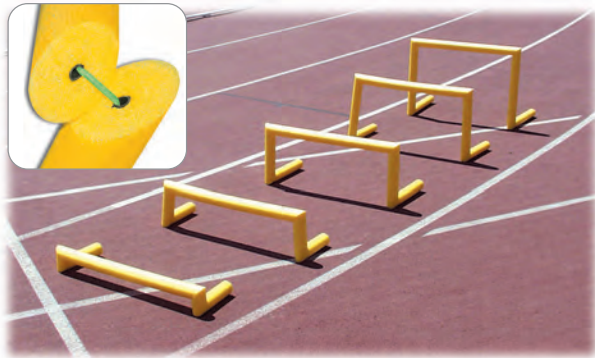

pg.5

**Art. P15421**

**Serie 5 ostacoli Over supersoft in polietilene espanso colore giallo, leggerissimi ideali per uso indoor**  
 altezza cm. 10-20-30-40-50 (il set comprende un ostacolo per ciascuna altezza)  
 Set of 5 Hurdles over supersoft yellow color very light, best for indoor use fixed height cm. 10-20-30-40-50

**Art. 031-AF**  
**031F / 031-BF / 032F**  
**033F / 034F / 035F**

**Ostacolo Over**  
 altezza fissa  
 cm. 12-20-30-40-50-60  
 in polipropilene  
 copolimero  
 alta resistenza  
 Ø mm. 32  
 colori: giallo fluo e  
 arancio fluo  
 Over Hurdle 12 - 20 - 30  
 40 - 50 - 60 cm. height  
 polypropylene  
 copolymer  
 pipe Ø mm. 32  
 (colors: fluo  
 yellow and fluo orange)



pg.4

**Polipropilene**  
**copolimero**  
**FLUO**  
 altamente  
 resistente e  
 flessibile fino a  
 -5 gradi!  
 Polypropylene  
 copolymer  
 fluorescent  
 highly  
 resistant and  
 elastic till minus  
 5 degrees!

**Art. C031 / C032 / C033 / C034**

**Ostacolo**  
 con cerniere (richiudibile)  
 in polipropilene  
 copolimero Ø mm. 32  
 colore giallo fluo  
 o arancio fluo  
 massima altezza  
 cm. 20 - 30 - 40 - 50  
 Hinged Hurdle  
 (foldable) in polypropylene  
 copolymer pipe Ø mm. 32  
 fluo yellow and fluo orange  
 20 - 30 - 40 - 50 cm.  
 maximum height



pg.4



**Art. 006**  
**Ostacolo con cerniere (richiudibile)**  
**altezza regolabile da 10 a 60 cm.**  
**in PVC Ø mm. 32**  
Hinged Hurdle (foldable)  
adjustable height  
from 10 to 60 cm. in PVC

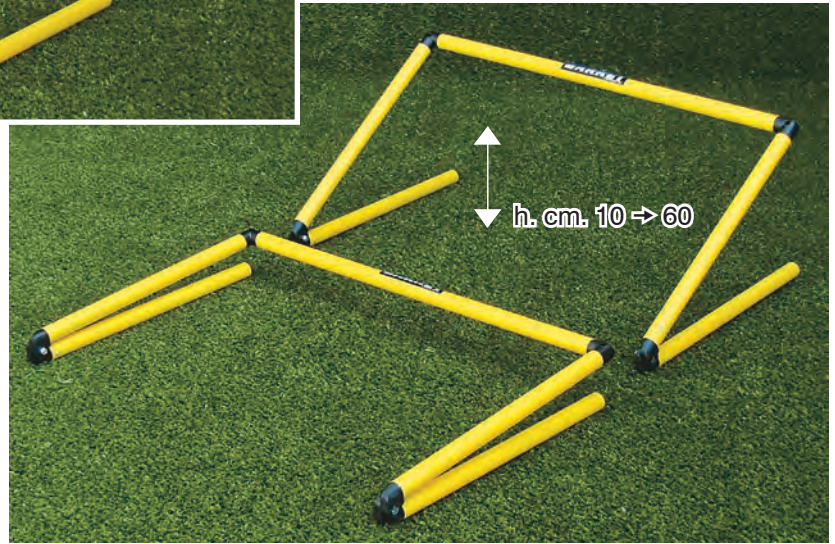

pg.5

**Art. 006F**  
**Ostacolo con cerniere (richiudibile)**  
**altezza regolabile da 10 a 60 cm.**  
**in polipropilene copolimero Ø mm. 32**  
**colore giallo fluo o arancio fluo**  
Hinged Hurdle (foldable) adjustable height  
from 10 to 60 cm. in polypropylene  
copolymer pipe Ø 32 mm.  
(colors: fluo yellow and fluo orange)



**Art. A004** **Ostacolo con cerniere (richiudibile)**  
**altezza regolabile da 10 a 60 cm.**  
**in alluminio Ø mm. 32**  
Hinged Hurdle (foldable) adjustable height  
from 10 to 60 cm. in aluminium



**Art. P0055**  
**Ostacolo Telescopico graduato, altezza regolabile da 40 a 60 cm. in PVC**

Telescopic Hurdle - graded - height adjustable from 40 to 60 cm. in PVC

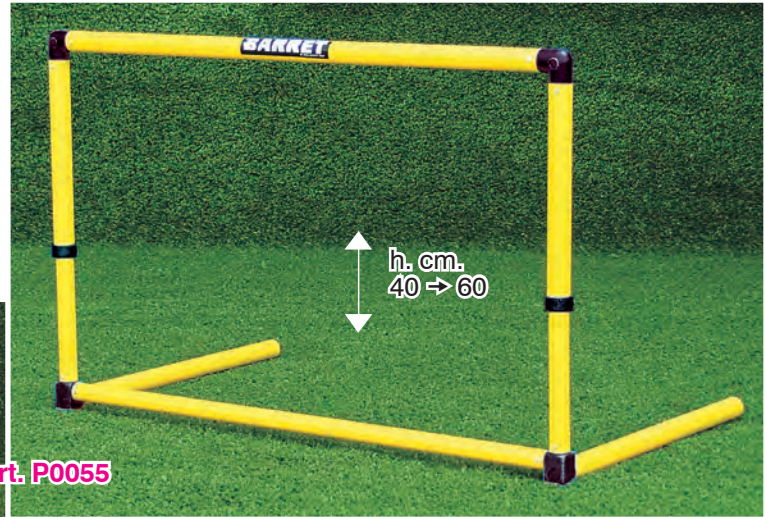

Art. P0055

**Completamente smontabili, minimo ingombro!**  
Dismountable legs, easy to transport

pg.5

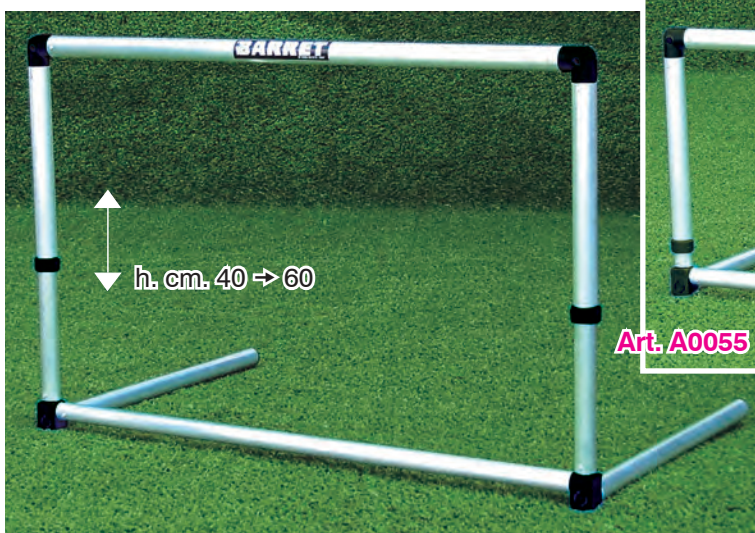

Art. A0055

**Art. A0055**  
**Ostacolo Telescopico graduato, altezza regolabile da 40 a 60 cm. in alluminio**

Telescopic Hurdle - graded - height adjustable from 40 to 60 cm. in aluminium

**Montanti graduati in cm.**  
Graded in cm.

**Completamente smontabili, minimo ingombro!**  
Dismountable legs, easy to transport





**Art. P005**  
**Ostacolo Telescopico graduato,**  
**altezza regolabile da 60 a 100 cm. in PVC**  
Telescopic Hurdle - graded - height adjustable  
from 60 to 100 cm. in PVC

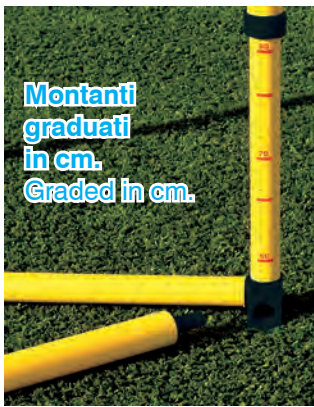
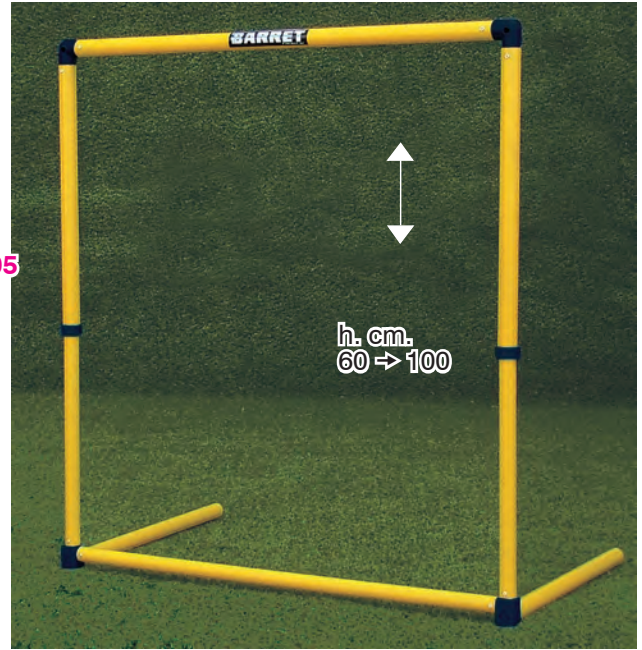
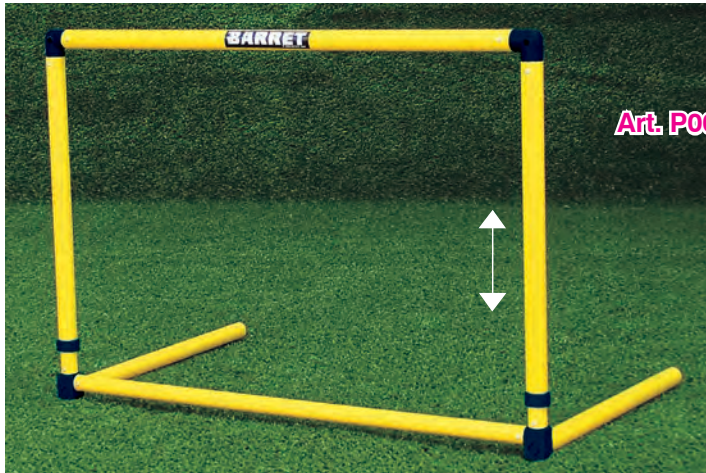

**Montanti graduati in cm.**  
**Graded in cm.**

**Completamente smontabili, minimo ingombro!**  
Dismountable legs, easy to transport

pg.5



**Art. A005**  
**Ostacolo Telescopico graduato,**  
**altezza regolabile da 60 a 100 cm. in alluminio**  
Telescopic Hurdle - graded  
height adjustable from 60 to 100 cm. in aluminium

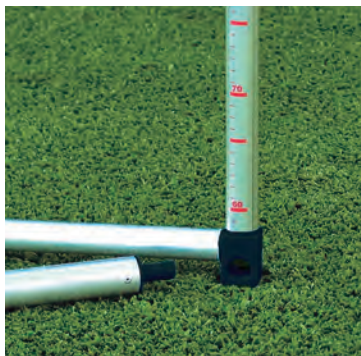
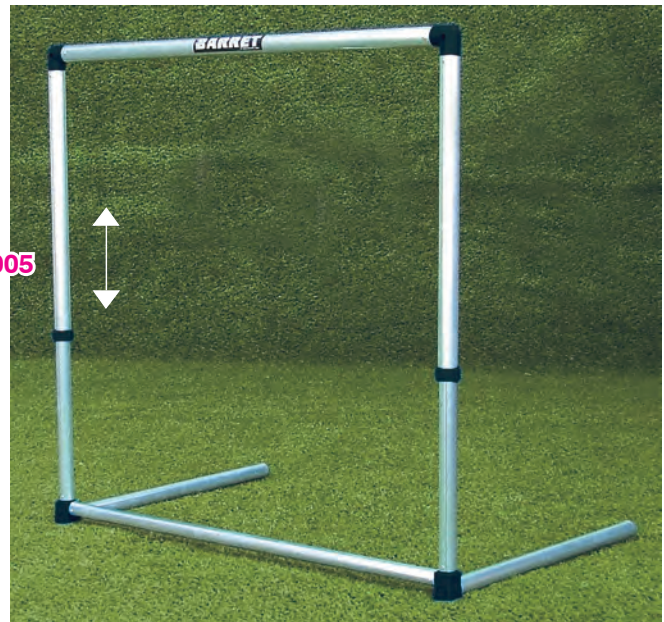
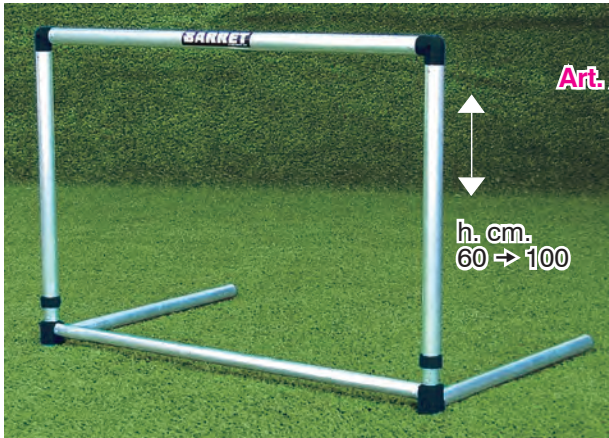

**Completamente smontabili, minimo ingombro!**  
Dismountable legs, easy to transport

**Montanti graduati in cm.**  
**Graded in cm.**

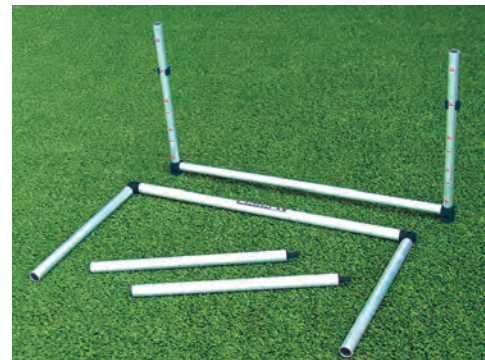

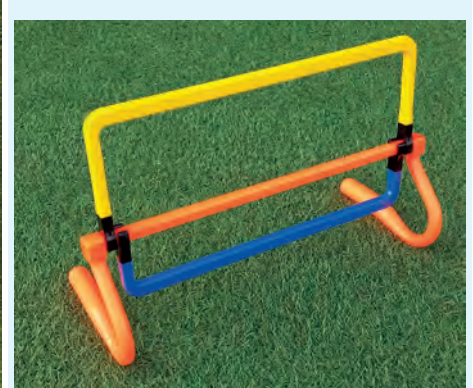
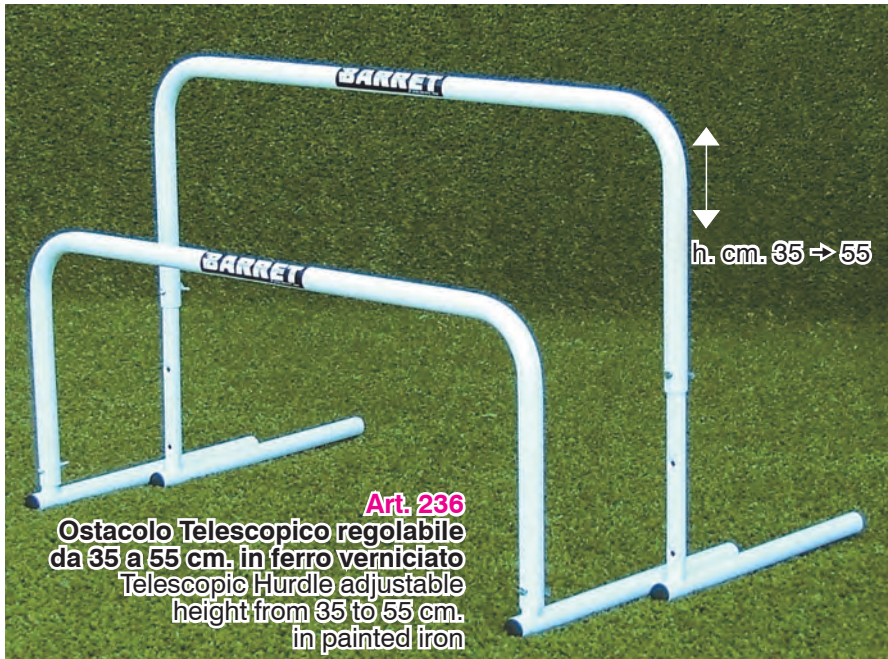

Art. H6912  
Mini-Ostacolo per bambini in plastica antiurto larghezza traversa cm. 45 altezza regolabile a cm. 15-23-30  
Mini-Hurdle for kids in plastic 45 cm. wide adjustable height at 15-23-30 cm.

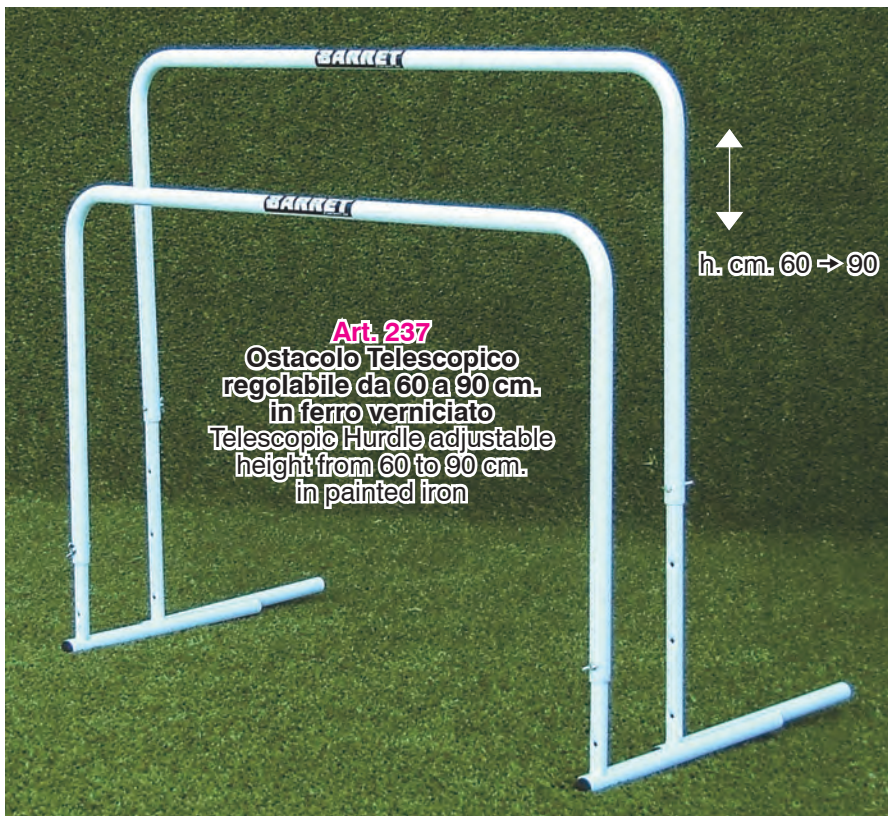

Art. 036  
Mini-Ostacolo per bambini in plastica regolabile da 10 a 50 cm.  
Mini-Hurdle for kids in plastic adjustable height from 10 to 50 cm.

IDEALI PER USO INDOOR E PER PALESTRE

For indoor use



**SEMPRE IN PIEDI  
DOPO OGNI URTO!  
THEY ALWAYS COME  
BACK UP AFTER  
ANY HIT!**

pg.5

**Art. 5020 / 5021 / 5022 / 5023**  
Ostacolo Basculante in PVC Ø mm. 28  
altezza fissa cm. 30 / 40 / 50 / 60  
Self-Straightening Hurdle in PVC fixed height,  
available in 30 / 40 / 50 / 60 cm.



pg.5

**Art. A5020 / A5021 / A5022 / A5023**  
Ostacolo Basculante in alluminio Ø mm. 28  
altezza fissa cm. 30 / 40 / 50 / 60  
Self-Straightening Hurdle in aluminium  
fixed height, available in 30 / 40 / 50 / 60 cm.

**SEMPRE IN PIEDI  
DOPO OGNI URTO!  
THEY ALWAYS COME  
BACK UP AFTER  
ANY HIT!**



## KIT CALCIO TENNIS - Soccer Tennis Kits



pg.6



**Art. 013.G** Kit calcio tennis pali in PVC con rete mt.10 - altezza cm.130 con tiranti, picchetti e sacca per terreni naturali  
Soccer Tennis Kit PVC poles 10 meter long 130 cm. height net with ropes, steel hooks and bag for natural grass



pg.6



**Art. 013.P**  
Kit calcio tennis con rete mt. 3 utilizzabile anche su terreni sintetici o indoor con sacca  
Soccer Tennis Kit 3 meter net - with bag also for artificial grass or indoor

**Art. 013.SP**

**Kit calcio tennis con rete cm.  
450x170  
utilizzabile anche  
su terreni sintetici o indoor**

**con sacca**

Soccer Tennis Kit 4,5x1,7 meter net  
with bag, also for artificial grass  
or indoor



● pg.6

**Art. 013.60**

**Kit calcio tennis  
con rete cm. 600x90  
utilizzabile anche  
su terreni sintetici  
o indoor con sacca**

Soccer Tennis Kit  
6,0x0,9 meter net  
with bag, also  
for artificial grass  
or indoor



**Art. 013.S**

**Kit Calcio Tennis TATTICO  
pali in polipropilene  
completo di rete in PVC mt. 2,30 regolabile in  
altezza, tiranti e basi in ferro verniciato  
utilizzabile anche su terreni sintetici o indoor**

Soccer Tennis Kit polypropylene poles  
with adjustable height PVC net 2,30 meter long,  
tightening ropes and painted steel bases  
also for artificial grass or indoor

**Nasconde per qualche istante la visione  
del pallone, determinando risposte a livello  
neuromuscolare e migliorando cinestesia e  
sensibilità nel tocco di palla**

This Soccer Tennis Kit hides the ball from  
player's visibility stimulating neuro muscular  
reflexes and improving ball control

● pg.6



**Art. 013.SB**

**Borsa per Kit calcio tennis  
Art. 013.S**

Bag to carry soccer tennis  
kit Art. 013.S



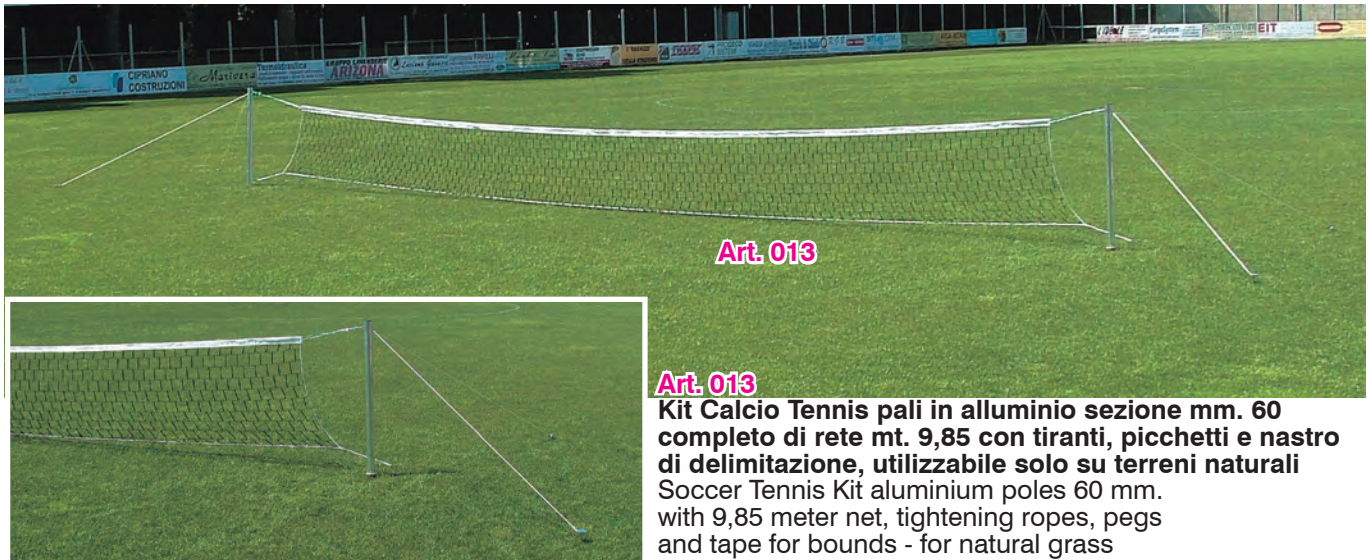

**Art. 013**



**Art. 013**

**Kit Calcio Tennis pali in alluminio sezione mm. 60 completo di rete mt. 9,85 con tiranti, picchetti e nastro di delimitazione, utilizzabile solo su terreni naturali**  
 Soccer Tennis Kit aluminium poles 60 mm. with 9,85 meter net, tightening ropes, pegs and tape for bounds - for natural grass

pg.6



**Art. 014**

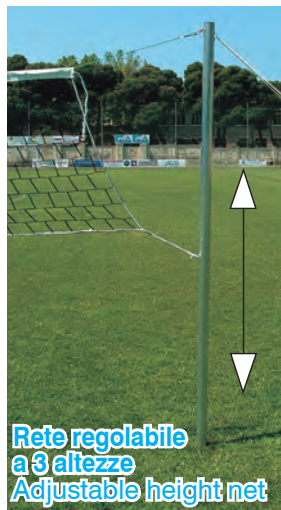

**Rete regolabile a 3 altezze**  
**Adjustable height net**

**Art. 014**  
**Kit Calcio Tennis pali in alluminio sezione mm. 60 completo di rete mt. 9,85 regolabile a 3 altezze (cm. 110/170/230) con tiranti, picchetti e nastro di delimitazione, utilizzabile solo su terreni naturali**  
 Soccer Tennis Kit aluminium poles 60 mm. with 9,85 meter net adjustable at 3 different heights, tightening ropes, pegs and tape for bounds for natural grass

pg.6

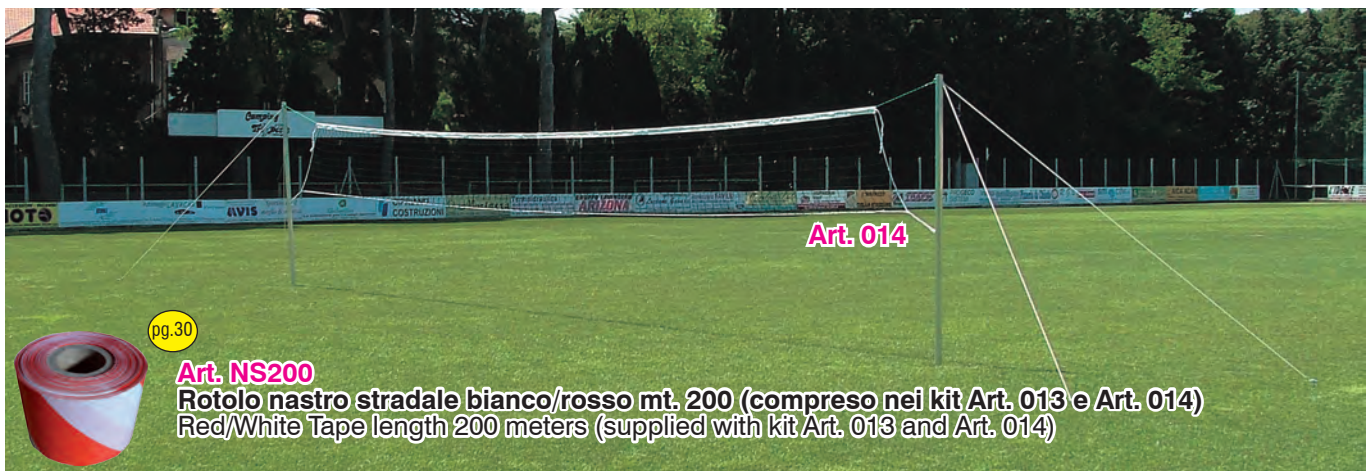

**Art. 014**



pg.30

**Art. NS200**  
**Rotolo nastro stradale bianco/rosso mt. 200 (compreso nei kit Art. 013 e Art. 014)**  
 Red/White Tape length 200 meters (supplied with kit Art. 013 and Art. 014)

## ARCHI DI PRECISIONE - Precision passing arcs

pg.5

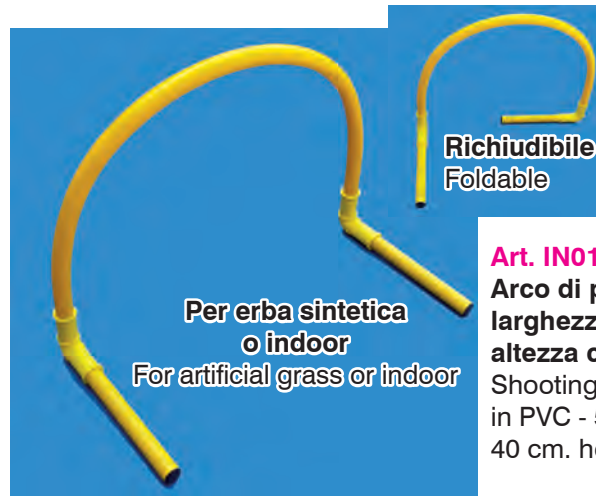

pg.6

**Art. IN01**  
Arco di precisione in PVC  
larghezza cm.50  
altezza cm.40  
Shooting/Passing Arc  
in PVC - 50 cm. width  
40 cm. height

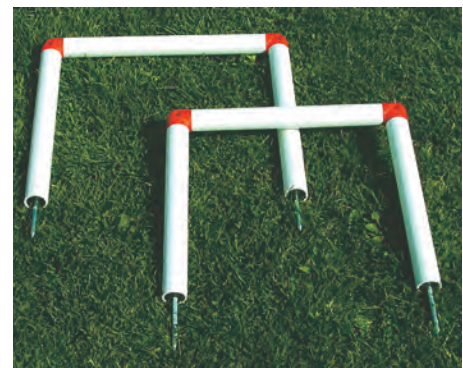

**Art. 020 / 021 / 022** pg.5 pg.6  
Arco di precisione in polipropilene  
Ø 40 mm. cm. 45x45 / 40x40 / 35x35  
Shooting/Passing Arc  
in polypropylene Ø 40 mm.  
dim. 45x45 / 40x40 / 35x35 cm.



**Art. A020 / A021 / A022**  
Arco di precisione  
in alluminio Ø 32 mm.  
cm. 45x45 / 40x40 / 35x35  
Shooting/Passing Arc  
in aluminium Ø 32 mm.  
dim. 45x45 / 40x40 / 35x35 cm.

pg.6



## FORCHE - Heading Trellises



**Art. F203**  
**Forca doppia**  
**in ferro verniciato**  
**telescopica, smontabile**  
**bussola inclusa**  
**altezza da terra cm. 300**  
**(palloni esclusi)**

Double Heading Trellis  
in painted iron  
telescopic, dismountable,  
underground socket included,  
height 300 cm. off ground  
(balls not included)



**Art. FAC242**  
**Forca singola in acciaio**  
**verniciato metallizzato Ø mm. 80**  
**su base in plastica riempibile**  
**da lt. 105 con ruote**  
**lunghezza braccio orizzontale cm. 150**  
**(pallone escluso)**  
Single Heading Trellis in painted steel  
pipe Ø 80 mm.  
105 lt. plastic base on wheels  
to be filled with water or sand  
horizontal length 150 cm.  
(ball not included)



**Art. F243**  
**Carrello con ruote pneumatiche per**  
**spostamento Art. FAC242 su terreni erbosi**  
Trolley with pneumatic wheels for moving  
Art. FAC242 on grass





**Art. 038**  
**Forca doppia**  
**in alluminio**  
**tubo sezione 60 mm.**  
**altezza da terra cm.300**  
**(palloni esclusi)**  
 Double Heading Trellis  
 in aluminium  
 pipe section 60 mm.  
 300 cm. height off ground  
 (balls not included)

**Art. B038**  
**Bussola per forca**  
**Art. 038 (optional)**  
 Underground socket  
 for Art. 038 (optional)



**Art. ACTP40**  
**Attrezzo per l'allenamento**  
**al colpo di testa**  
**applicabile a porte di qualsiasi tipo**  
**per mezzo di fettucce elastiche,**  
**in PVC Ø mm. 40**  
**(pallone escluso)**  
 Header training tool  
 to be easily applied to goals of any type  
 by means of elastic tapes,  
 PVC pipe Ø 40 mm.  
 (ball not included)

pg.6



**Art. 039.4**  
**Pallone per**  
**forca in pelle**  
 **sintetica**  
 **disponibile**  
 **mis. 4**  
 Ball for  
 Heading Trellis,  
 in synthetic  
 leather  
 available  
 size 4



**Art. ULTVE5**  
**Pallone per forca Trial n. 5 in gomma**  
 **doppio strato gr. 420 Ø cm. 21,5**  
 Trial rubber Ball for Heading trellis  
 size 5 double stratum

**Art. ULTVE4**  
**Pallone per forca Trial n. 4 in gomma**  
 **doppio strato gr. 250 Ø cm. 20**  
 Trial rubber Ball for Heading trellis  
 size 4 double stratum



**Con questo attrezzo**  
**è possibile verificare**  
 **giornalmente i**  
 **miglioramenti**  
 **nell'elevazione**  
 **degli atleti**  
 This instrument tests  
 players' daily jump  
 improvements



pg.10

**Art. HJT Head Jump Tester - strumento polivalente di misurazione ed**  
 **allenamento, permette la valutazione delle qualità muscolari degli arti inferiori,**  
 **dell'elevazione dei giocatori, del loro modo di colpire la palla di testa e**  
 **dell'ampiezza del tuffo del portiere**  
 Instrument that allows the training and measurement of jump ability of players  
 and goalkeepers

## BARRIERE SPECIALI - GK TRAINING

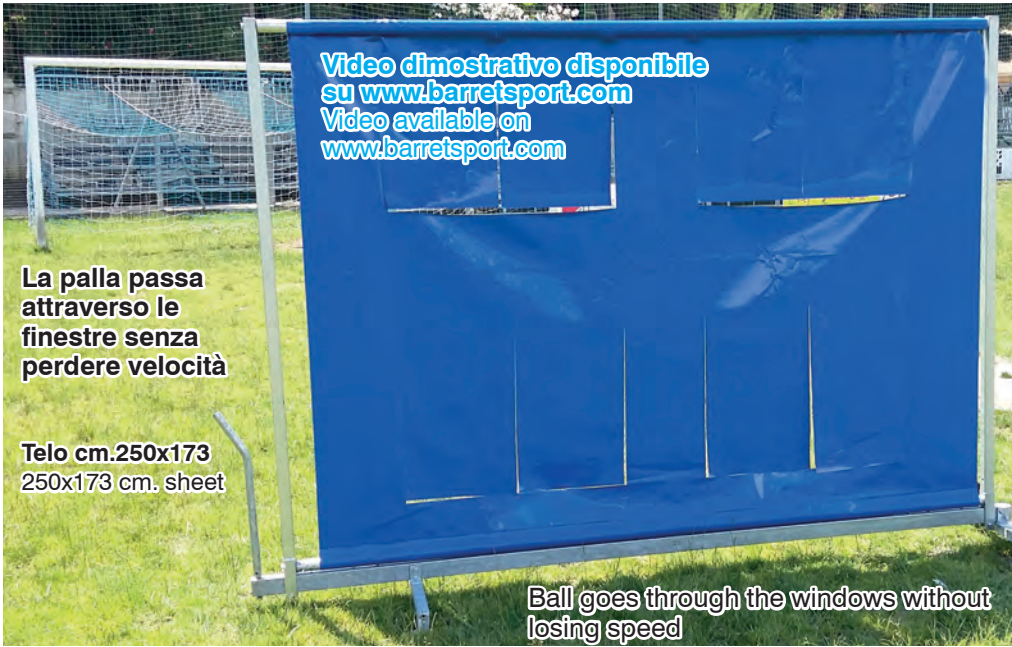

La palla passa attraverso le finestre senza perdere velocità

Telo cm.250x173  
250x173 cm. sheet

Ball goes through the windows without losing speed

**Art. 003WB**  
**BARRIERA CON FINESTRE** per l'allenamento ai calci di punizione e per il miglioramento dei tempi di reazione del portiere in caso di tiri improvvisi **kit completo**  
WINDOW BARRIER for free kicks and Goalkeeper training to fast and sudden shots **complete kit**

pg.1

**Art. 003WBS**  
**STRUTTURA SUPERIORE** barriera con finestre, applicabile al carrello porta sagome Art. 003 Window Barrier UPPER PART to be fixed upon trolley Art. 003



**Art. 003RX**  
**BARRIERA FILTRANTE REFLEX kit completo**  
REFLEX FILTERING BARRIER on wheels - complete kit

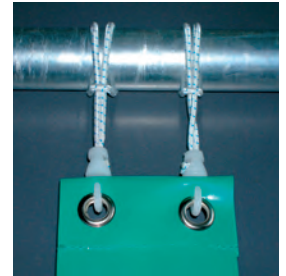

**Nuovo sistema di fissaggio**  
New more resistant elastics and hooks

pg.1

**Art. 003RXS**  
**STRUTTURA SUPERIORE** barriera filtrante REFLEX, applicabile al carrello porta sagome Art. 003 Reflex Filtering Barrier UPPER PART to be fixed upon trolley Art. 003



**INNOVATIVO ATTREZZO FONDAMENTALE PER L'ALLENAMENTO DEI RIFLESSI DEL PORTIERE. LA PALLA (INVISIBILE PER IL PORTIERE AL MOMENTO DEL CALCIO) FILTRA ATTRAVERSO LE STRISCE ED ARRIVA IN PORTA ALL'IMPROVISO ASSUMENDO TALVOLTA TRAIETTORIE IMPREVEDIBILI. ATTREZZO DA POSIZIONARE IN PROSSIMITÀ DELL'AREA PICCOLA**

**A revolutionary device for goalkeeper's reflex training. The goalkeeper cannot see the ball until it passes through the stripes. The direction of the ball is often unpredictable! To be placed not too far from goalkeeper's area**



**L'ATTREZZO PUO' INOLTRE ESSERE UTILIZZATO COME UNA COMUNE BARRIERA PER L'ALLENAMENTO DEI CALCI DI PUNIZIONE**

**It is also very useful for free kick practising for both kicker and goalkeeper!**



## MURI - TELAI CON RETE - Rebounders - Iron frames with net



Vista frontale  
Front view



Vista laterale  
Side view

Video dimostrativo  
disponibile  
su [www.barretsport.com](http://www.barretsport.com)  
Video available on  
[www.barretsport.com](http://www.barretsport.com)

**Art. 5011**

**Muro per allenamento portieri in vetroresina  
montato su telaio con 4 ruote**

Fiberglass Goalkeeper Rebounder  
mounted on frame with  
4 wheels

**Dimensioni:**  
altezza cm.200  
larghezza cm.130  
profondità cm.80  
peso Kg.100

Dimensions:  
height 200 cm.  
width 130 cm.  
depth 80 cm.  
weight 100 Kg.

pg.6

**Calciando o lanciando la palla  
verso il muro, essa assumerà  
traiettorie di rimbalzo  
imprevedibili favorendo  
l'allenamento dei riflessi  
del portiere**

By kicking or throwing the ball  
against the wall it will rebound in  
different directions,  
testing and training GK's reflexes



Vista posteriore  
Back view

**Zavorra  
in cemento  
inclusa**  
Concrete  
ballast  
included

**Consente l'allenamento con  
o senza il preparatore atletico**  
Goalkeeper can exercise  
by himself as well



**Con superficie superiore a semisfere  
e superficie inferiore piana**  
Upper side with hemispheres  
and flat lower side



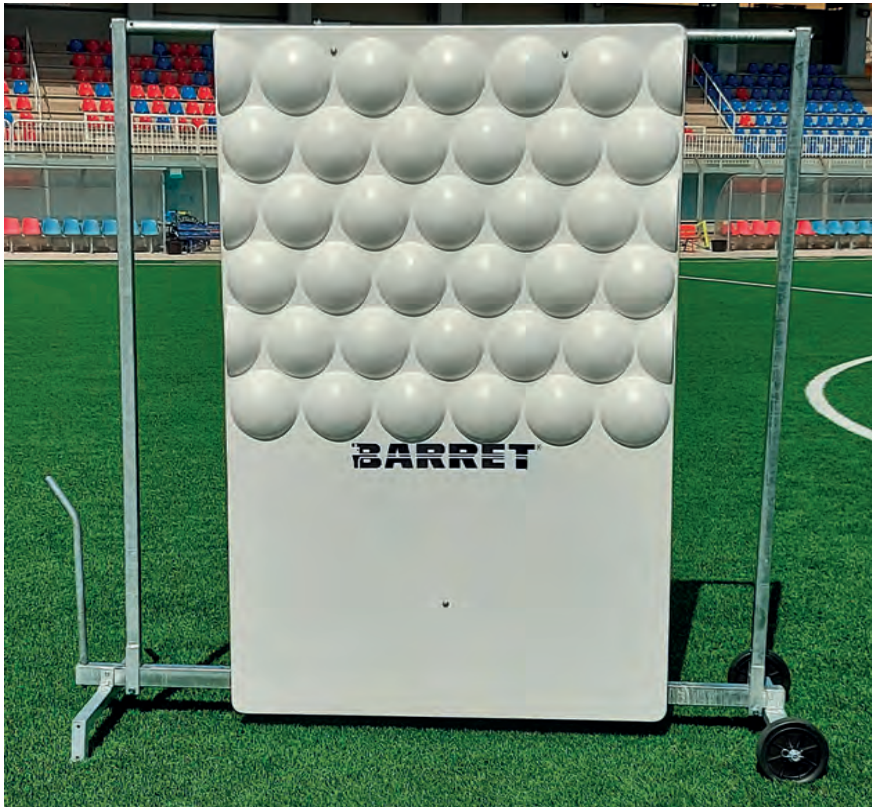

pg.6



**Art. 5012SC**  
**Muro per allenamento portieri in vetroresina cm. 200x130**  
**installato su carrello in acciaio zincato con ruote Art. NCP3S**  
 Fiberglass Goalkeeper rebounder 200x130 cm. installed on a  
 galvanized steel trolley with wheels Art. NCP3S

pg.6

**Art. KMC3S**  
**Kit superiore muro allenamento**  
**portieri per adattamento a carrello**  
**Art. NCP3S oppure Art. 003**  
 Rebounder kit upper part to be fixed  
 upon trolley Art. NCP3S or Art. 003

**Rimuovendo il pannello in vetroresina**  
**ed eventualmente il telaio di sostegno,**  
**si può utilizzare il carrello porta 3**  
**sagome Art. NCP3S**

By removing the fiberglass panel and the  
 support frame, you can use the trolley for  
 carrying 3 mannequins Art. NCP3S



**Art. PVLSC**  
**Pannello in vetroresina con superficie superiore a semisfere e superficie inferiore liscia, munito di ganci e**  
**staffa per ancoraggio - dimensioni cm. 200x130**  
**Può essere acquistato separatamente ed installato facilmente sulla Barriera Filtrante Reflex Art. 003RX**  
**oppure sulla Barriera con Finestre Art. 003WB**  
 Fiberglass panel with upper hemisphere surface and lower smooth surface, equipped with hooks and anchor  
 bracket - size 200x130 cm. It can be purchased separately and easily installed both on the Reflex Filtering Barrier  
 Art. 003RX and on the Window Barrier Art. 003WB



**Dimensioni:**  
m. 1,3 larghezza x m. 1,1 altezza  
ciascuna faccia  
**peso Kg. 50**  
Dimensions:  
1,3 m. width x 1,1 m. height  
every side  
weight 50 Kg.

● pg.6

**Art. R1150**

**Muro per allenamento giocatori e portieri a 2 facce di cui una piana ad inclinazione regolabile ed una con emisfere, interamente in vetroresina montato su telaio con 4 ruote**  
2 side Fiberglass Players and Goalkeepers' Rebounder mounted on frame with 4 wheels  
the flat side can be inclined, the fixed side with hemispheres



**Attraverso l'utilizzo della parete ad inclinazione regolabile è possibile determinare traiettorie di risposta della palla verso l'alto al fine di sollecitare il tiro al volo, il colpo di testa ed il controllo di palla**  
**Calcando o lanciando la palla verso la parete con emisfere, essa assumerà traiettorie di rimbalzo imprevedibili favorendo l'allenamento dei riflessi del portiere e dei giocatori**  
Thanks to the adjustable inclination of the flat side you can get an upward ball rebound and train acrobatic shooting, headers and ball control  
Through the use of the side with hemispheres you can get unpredictable trajectories for training goalkeepers' reflexes and players' reactivity



**Art. 5050**

**Muro per allenamento giocatori a 2 facce di cui una ad inclinazione regolabile, interamente in vetroresina montato su telaio con 4 ruote**  
2 side Fiberglass Players' Rebounder mounted on frame with 4 wheels  
one side can be inclined

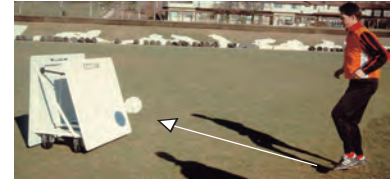

**Kg. 50**



● pg.6



**Dimensioni:**  
m. 1,3 larghezza x m. 1,1 altezza  
ciascuna faccia  
**peso Kg. 50**  
Dimensions:  
1,3 m. width x 1,1 m. height  
every side  
weight 50 Kg.

**Attraverso l'utilizzo della parete ad inclinazione regolabile è possibile determinare traiettorie di risposta della palla verso l'alto al fine di sollecitare il tiro al volo, il colpo di testa ed il controllo di palla**  
Thanks to the adjustable inclination you can get an upward ball rebound and train acrobatic shooting, headers and ball control



**Kg. 50**



● pg.6

**Art. 5010**  
**Muro per allenamento giocatori a 3 facce in vetroresina montato su telaio con 3 ruote**  
3 side Fiberglass Players' Rebounder mounted on frame with 3 wheels  
Dimensions: 1,3 m. width x 1,1 m. height  
every side  
weight 50 Kg.



**Art. MP501N**

**Muro prismatico in vetroresina a 3 facce piane di dimensioni  
cm.107x140 - cm.107x120 - cm.107x108 - peso Kg.48 - con asole per il trasporto  
\*\*utilizzabile contemporaneamente da 2 lati ed in 4 diverse posizioni\*\***

3 side Fiberglass Players' Rebounder with side dimensions  
107x140 cm. - 107x120 cm. - 107x108 cm. weight 48 Kg. with slots for transport  
**\*\*allows 4 different training positions on both sides simultaneously\*\***

pg.7



Permette di ottenere la più ampia varietà di rimbalzi e traiettorie, utili per il miglioramento del controllo di palla, del passaggio, del tiro al volo e del colpo di testa

1

**Posizione "in piedi" con 3 facce perpendicolari al terreno di gioco**  
Standing position with all sides perpendicular to the ground



2

**Posizione con base a terra cm.107x108**  
**Allenamento con superfici di rimbalzo ad inclinazione alta e medio-alta**  
Position with 107x108 cm. base  
Training with high and medium inclination rebounding sides

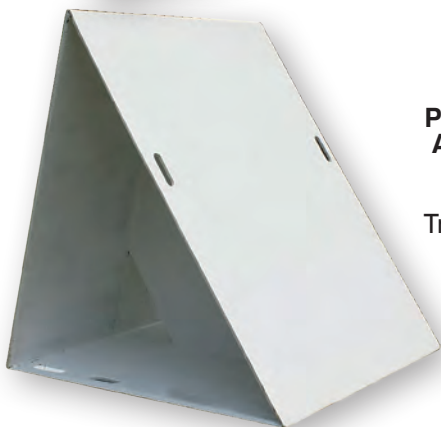

Allows the widest variety of rebounds in order to improve ball control, passing and shooting



3

**Posizione con base a terra cm.107x120**  
**Allenamento con superfici di rimbalzo ad inclinazione alta e bassa**  
Position with 107x120 cm. base  
Training with high and low inclination rebounding sides



4

**Posizione con base a terra cm.107x140**  
**Allenamento con superfici di rimbalzo ad inclinazione medio-bassa e bassa**  
Position with 107x140 cm. base  
Training with medium-low and low inclination rebounding sides

**Rinforzo interno per l'ottimizzazione del rimbalzo**  
Internal reinforcement for rebound improvement

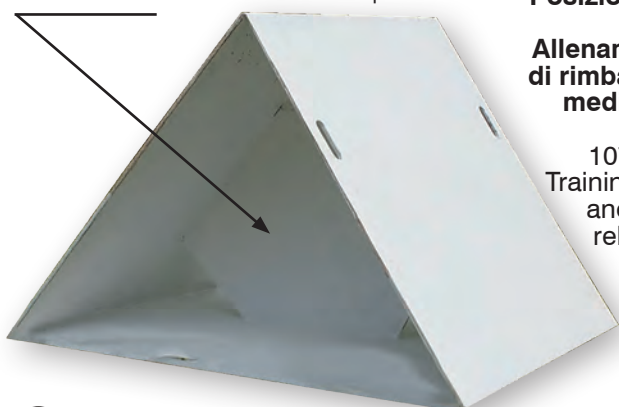

**Art. PLRB16**

**Muro prismatico PROFESSIONALE in vetroresina a 3 facce piane larghezza cm.130 - altezza massima cm.65 con asole per il trasporto - peso kg.18**  
**\*\*utilizzabile contemporaneamente da 2 lati ed in 3 diverse posizioni\*\***

PROFESSIONAL 3 side Fiberglass Players' Rebounder width 130 cm. - maximum height 65 cm. with slots for transport - 18 kg. weight  
**\*\*allows 3 different training positions on both sides simultaneously\*\***

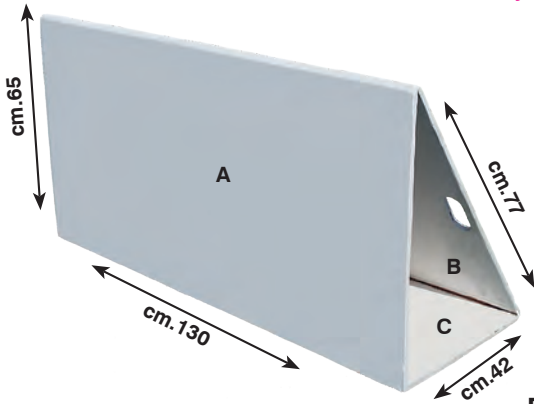

**1**

**Posizione con superficie A perpendicolare al terreno e superficie B molto inclinata**

Position with 90 degrees A side and high inclination B side

**Art. PLRB23**

**Muro prismatico in legno multistrato marino a 3 facce piane larghezza cm.122 altezza massima cm.65 con asole per il trasporto - peso kg.20**  
**\*\*utilizzabile contemporaneamente da 2 lati ed in 3 diverse posizioni\*\***

3 side marine plywood Players' Rebounder width 122 cm. - maximum height 65 cm. with slots for transport - 20 kg. weight  
**\*\*allows 3 different training positions on both sides simultaneously\*\***

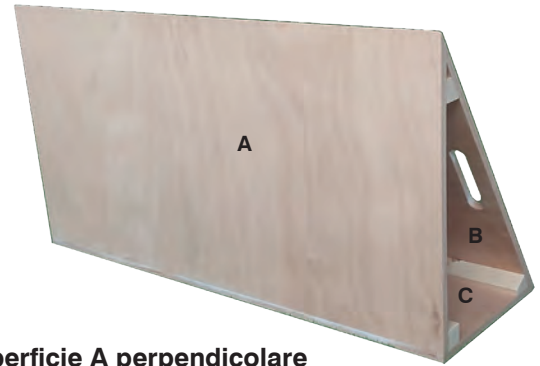

**2**

**Video dimostrativo disponibile su [www.barretsport.com](http://www.barretsport.com)**  
 Video available on [www.barretsport.com](http://www.barretsport.com)

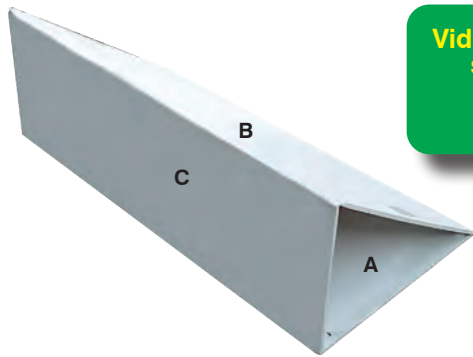

**Posizione con superficie C perpendicolare al terreno e superficie B inclinata**

Position with 90 degrees C side and low inclination B side

**Prodotto professionale in vetroresina con rinforzo interno per l'ottimizzazione del rimbalzo**  
 Professional in fiberglass with internal reinforcement for rebound improvement

**Si consiglia di utilizzare una zavorra all'interno dell'attrezzo per conferire maggiore stabilità**  
 It is recommended to place a weight inside for great stability

**3**

**Posizione con superfici A e C a diverse inclinazioni**  
 Position with A and C sides differently inclined

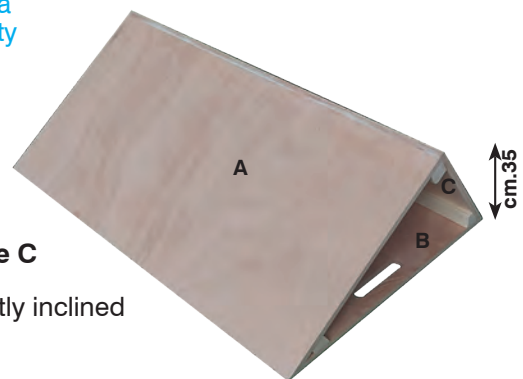
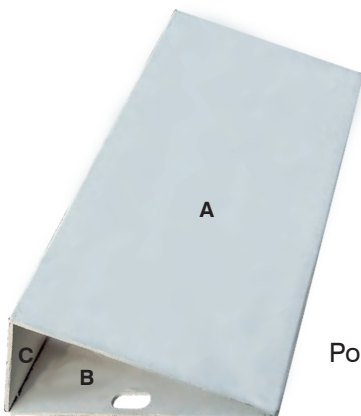

**Permettono di ottenere la più ampia varietà di rimbalzi e traiettorie, utili per il miglioramento del controllo di palla, del passaggio, del tiro al volo e del colpo di testa**

**They allow the widest variety of rebounds in order to improve ball control, passing and shooting**



**Art. PAR180**  
**PLANCHE À REBONDS**  
Parete rimbalzante realizzata in PE  
(all'esterno) e PU (all'interno)  
ideale per l'effettuazione  
di esercizi individuali e di  
gruppo volti al miglioramento  
della coordinazione motoria,  
del controllo di palla,  
del passaggio e del tiro  
Rebound board made of PE (outside)  
and PU (inside)  
very useful for individual and  
group exercises aimed to improve  
coordination, ball control,  
passing and shooting



**Dimensioni: lunghezza cm. 180**  
**altezza cm. 50**  
**profondità cm. 34**  
**peso kg. 23**

Dimensions: length 180 cm.  
height 50 cm.  
depth 34 cm.  
weight 23 kg.

pg.7

La distribuzione dei volumi appesantiti consente ottima stabilità e perfetto bilanciamento anche negli impatti più potenti.  
Tuttavia, se lo si ritiene necessario, è possibile aggiungere peso mediante sabbia o acqua  
The distribution of the weighted volumes allows excellent stability and perfect balance even with the most powerful shots.  
However, if necessary, sand or water can be added



pg.7

**Art. TM001**  
Muro triangolare in legno multistrato marino,  
trattato con vernice impermeabilizzante  
dimensioni lato cm.150x50  
Attraverso l'uso in posizione verticale è possibile  
determinare traiettorie di risposta della palla verso l'alto  
al fine di sollecitare il tiro a volo, il colpo di testa e lo  
stop (ad esaurimento)  
Triangular rebounder made of marine plywood treated with  
special paint against humidity - side size 150x50 cm.  
By placing it in vertical position you will receive an upward  
ball rebound to train acrobatic shooting, header and ball  
control (until available)

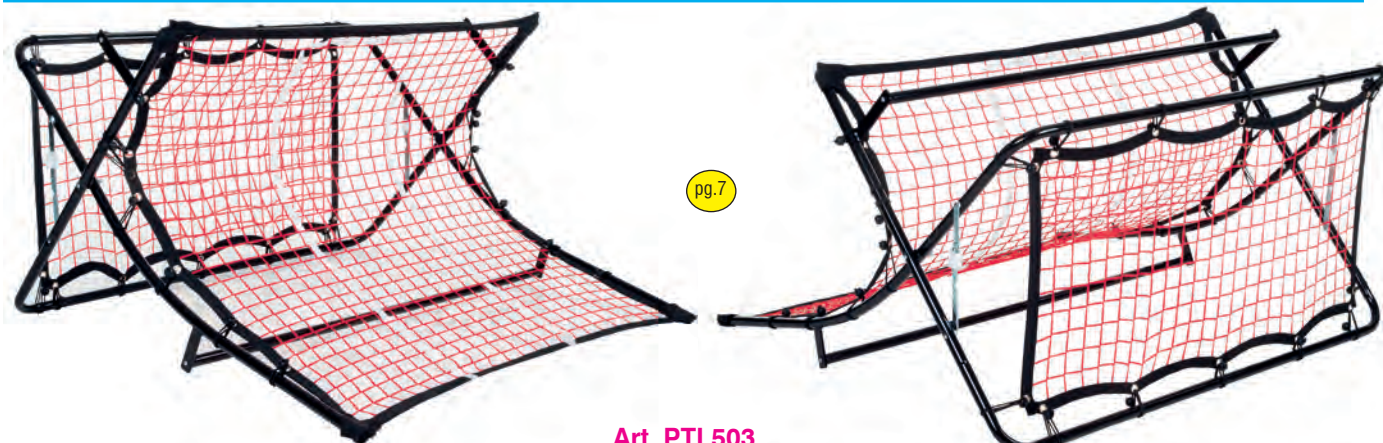

pg.7

**Art. PTI.503**  
Telaio con rete in acciaio verniciato, bifacciale ricurvo su un lato - inclinazione regolabile dim. cm. 111x105x63  
2 face adjustable inclination iron frame with net for goalkeepers and players size 111x105x63 cm.



**Art. SCVR16**

**Disco in vetroresina con maniglie per l'allenamento della reattività del portiere sulle deviazioni da tiro o colpo di testa ravvicinato diametro cm.47 peso kg.2**

Fiberglass Discus with handles

for close shot and deflection GK training - diameter 47 cm. weight 2 kg.

pg.7



**Art. 5030.T**

**Telaio con rete in alluminio dim. cm.90x70 ad inclinazione regolabile con maniglie impugnabili dal preparatore.**

**Consente la simulazione di colpi di testa e tiri acrobatici per un allenamento alternativo del portiere**

Aluminium frame with net size 90x70 cm. adjustable inclination with handles for trainer to simulate headers and acrobatic shooting trajectories for new GK exercises

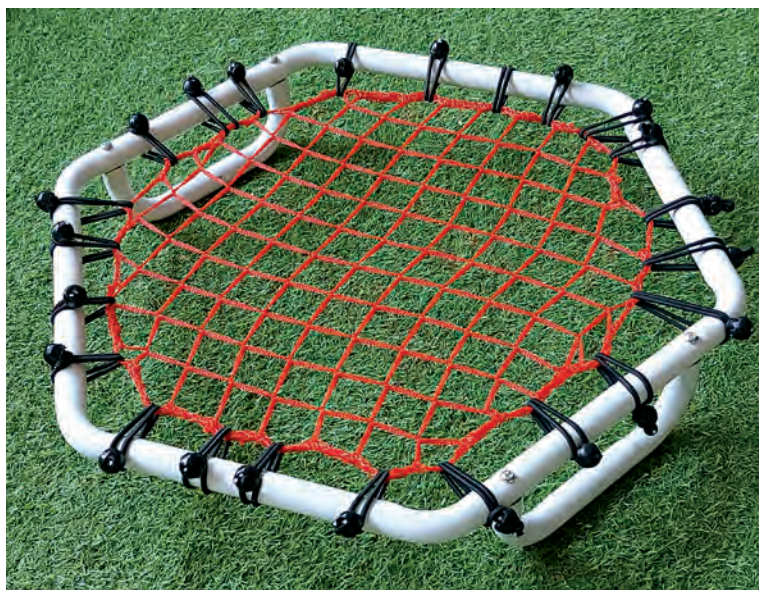

**Art. PTI.5858**

**Telaio con rete esagonale in metallo verniciato dim. cm.65x58 con maniglie impugnabili dal preparatore.**

**Consente la simulazione di colpi di testa e tiri acrobatici per un allenamento alternativo del portiere**

Hexagonal metal frame with net size 65x58 cm. with handles for trainer to simulate headers and acrobatic shooting trajectories for new GK exercises

pg.7



**Art. 5030**  
Telaio con rete cm. 130 x 130  
in ferro verniciato  
ad inclinazione regolabile  
Painted iron frame with net,  
dimensions 130 x 130 cm.  
adjustable inclination

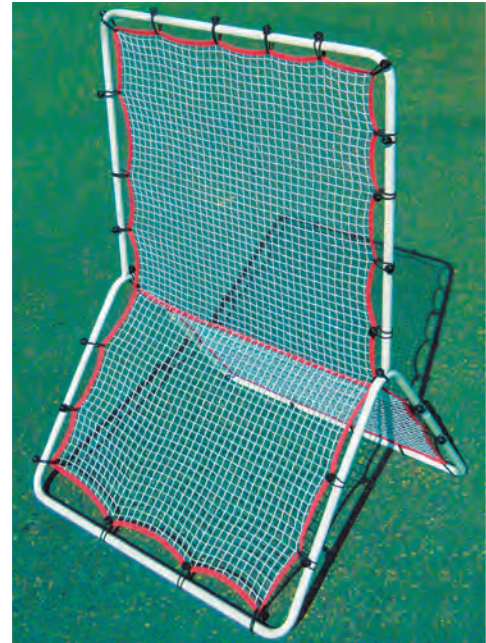

**Art. 503.BF**  
Telaio con rete in ferro verniciato, bifacciale  
a doppia inclinazione, altezza cm.150 larghezza  
cm.100 con picchetti per fissaggio a terra,  
per allenamento portieri e giocatori  
Iron frame with net, in painted iron 2 sides double  
inclination height 150 cm. width 100 cm. with anchoring  
hooks for goalkeepers and players

pg.7

**Art. 5035G** Telaio con rete cm.105 x 105 in ferro cromato ad  
inclinazione regolabile, per allenamento portieri e giocatori  
Iron frame with net in chromed iron dimensions 105 x 105 cm.  
adjustable inclination for goalkeepers and players

**Prodotto professionale  
in ferro cromato**  
Professional in  
chromed iron



**Prodotto professionale  
in ferro zincato**  
Professional in  
galvanized iron

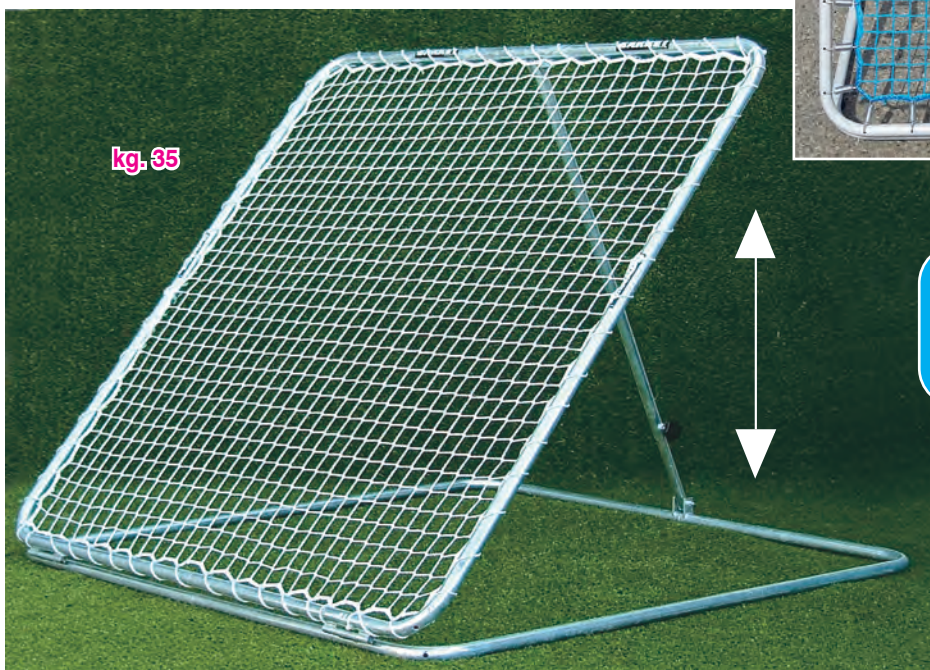

**Art. 5040**  
Telaio con rete cm. 140 x 140  
in ferro zincato ad inclinazione  
regolabile, per allenamento  
portieri e giocatori  
Iron frame with net in galvanized  
iron dimensions 140 x 140 cm.  
adjustable inclination  
for goalkeepers and players

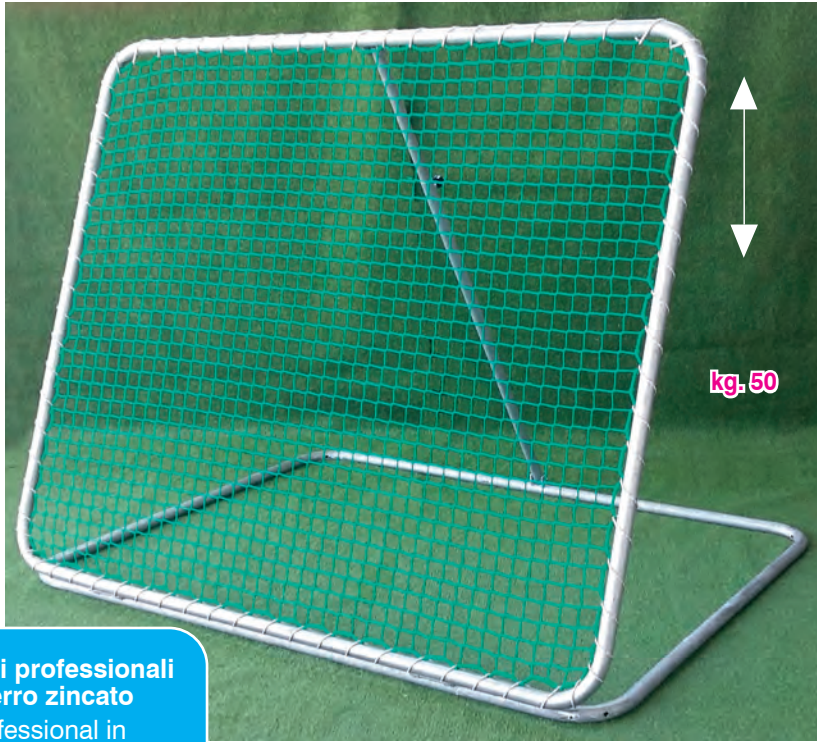

**Art. 50.220**  
**Telaio con rete**  
**cm. 220 x 180**  
**in ferro zincato**  
**ad inclinazione regolabile,**  
**per allenamento**  
**portieri e giocatori**  
 Iron frame with net in  
 galvanized iron dimensions  
 220 x 180 cm.  
 adjustable inclination  
 for goalkeepers and players



**Art. ST221**  
**Set 4 ruote con staffa per un**  
**agevole trasporto del telaio**  
**Art. 50.220 (optional)**  
 Set of 4 wheels with bracket  
 for Art. 50.220 (optional)

**Prodotti professionali**  
**in ferro zincato**  
 Professional in  
 galvanized iron



**Art. 5041**  
**Telaio con rete cm. 315 x 230**  
**in ferro zincato ad inclinazione regolabile,**  
**per allenamento portieri e giocatori**  
 Iron frame with net, in galvanized iron  
 dimensions 315 x 230 cm.  
 adjustable inclination  
 for goalkeepers and players

kg. 75

pg.7



**Art. ST441**  
**Set 4 ruote con staffa per un agevole**  
**trasporto del telaio Art. 5041 (optional)**  
 Set of 4 wheels with bracket for Art. 5041 (optional)



**Video dimostrativo disponibile su [www.barretsport.com](http://www.barretsport.com)**  
 Video available on [www.barretsport.com](http://www.barretsport.com)

**Art. DT01**  
**Deviatore di traiettoria**  
 Tubi in alluminio, con cerniere e piedini di stabilità.  
 Coadiuvano l'allenamento quotidiano del portiere ed il suo eventuale recupero post traumatico  
**BREVETTATO**  
 SHOT DEVIATOR - pipes in aluminium, with hinges and stability pegs - very useful to improve GK reactivity and to accelerate injury recovery  
**PATENTED**

**Brevettato**  
**Patented**

● pg.6

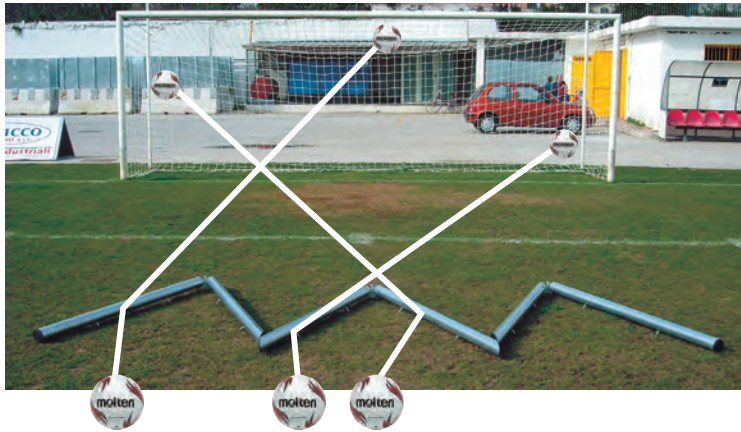

**Borsa per il trasporto inclusa**  
 Bag included

**Si consiglia di inumidire l'erba di fronte all'attrezzo per incrementare la velocità della palla calciata rasoterra prima dell'impatto con il Deviatore**  
 We recommend to wet the grass in front of the training device in order to let the ball hit the deviator at a higher speed



**Art. BP63**  
**BALL PLAYNING Modello Mundial - telo in PVC con rilievi gonfiabili e riempiibili con acqua per l'allenamento dei riflessi del portiere, metri 6x2,5 completo di borsa, pompa per la gonfiatura e sacca per il trasporto dell'acqua**  
 Ball Playning Mundial for GK training in PVC size 6x2,5 meters with air and water bubbles, complete with pump and bag

● pg.6

**Video dimostrativo disponibile su [www.barretsport.com](http://www.barretsport.com)**  
 Video available on [www.barretsport.com](http://www.barretsport.com)

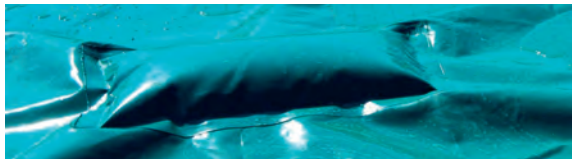

**Bagna il Ball Playning prima dell'uso per incrementare la velocità della palla!**  
 Always wet your Ball Playning to increase ball speed!



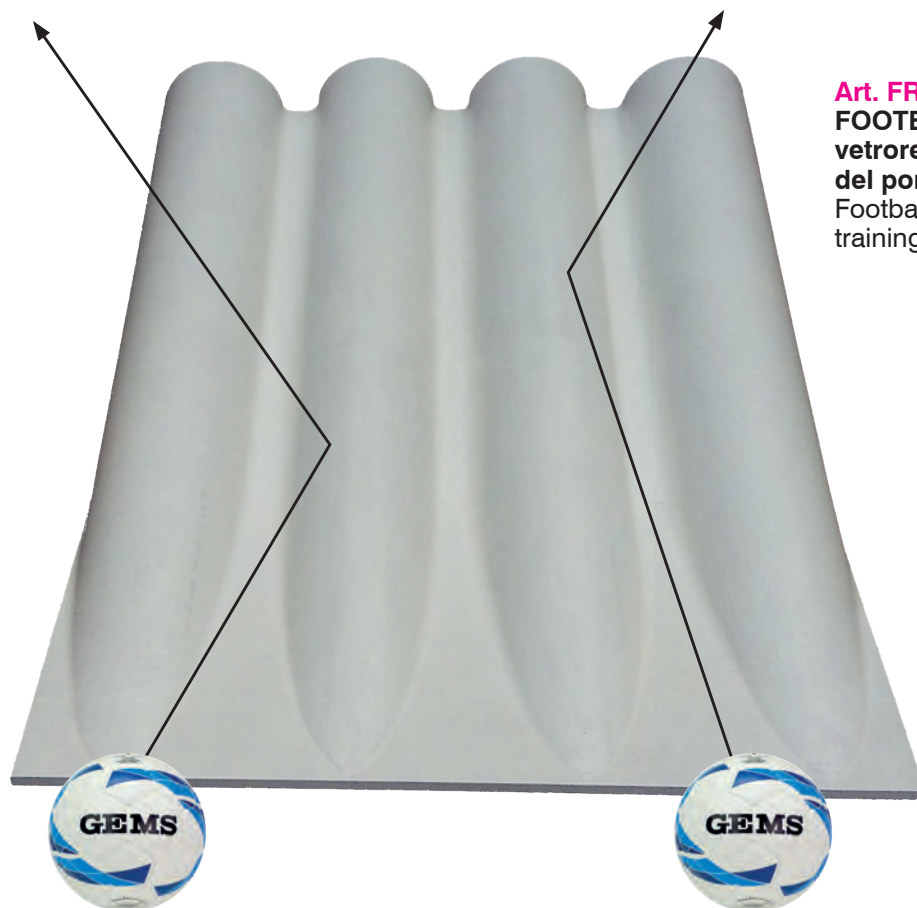

**Art. FRM16**  
**FOOTBALL RAMP - attrezzo in vetroresina per l'allenamento dei riflessi del portiere sui tiri ravvicinati e deviati**  
Football Ramp - fiberglass deviator for GK training to close highly deflected shots

**Bagna il Football Ramp prima dell'uso per incrementare la velocità della palla!**  
Always wet your Football Ramp to increase ball speed!

● pg.7

**dimensioni: cm.150x110 ad inclinazione regolabile per mezzo di due piedi telescopici**  
dimensions: 150x110 cm. adjustable inclination by means of two telescopic feet



**Video dimostrativo disponibile su [www.barretsport.com](http://www.barretsport.com)**  
Video available on [www.barretsport.com](http://www.barretsport.com)

● pg.6

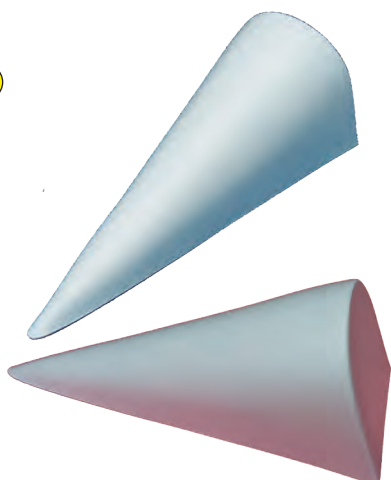

**Art. BDV15**  
**Cuspide in vetroresina appesantita con cemento, dimensioni cm.56x21x21h per allenamento dei riflessi del portiere**  
Fiberglass cusp with concrete filling  
dimensions 56x21x21 cm. for GK training

**Posizionando una serie di cuspidi nell'area piccola si ottengono deviazioni della palla improvvise, utili per l'allenamento dei riflessi e della reattività del portiere**  
Train goalkeeper's reactivity to sudden and close deflections by placing a number of cusps near the GK's area



**Video dimostrativo disponibile su [www.barretsport.com](http://www.barretsport.com)**  
 Video available on [www.barretsport.com](http://www.barretsport.com)

**Art. FRA**  
**FOOTBALL RACK** - attrezzo in ferro zincato per l'allenamento dei riflessi del portiere sui tiri ravvicinati e deviati  
 dimensioni cm.160x54 - peso kg. 13  
 Football Rack - galvanized iron deviator for training of GK reflexes on close and deflected shots  
 size 160x54 cm. - weight 13 kg.

pg.7



**Art. FW18**  
**FOOTBALL WAVE** - attrezzo in policarbonato per l'allenamento dei riflessi del portiere sui tiri ravvicinati e deviati  
 dimensioni cm. 90x60 - peso kg. 5  
 Football Wave - polycarbonate deviator for training of GK reflexes on close and deflected shots  
 size 90x60 cm. - weight 5 kg.



**Bagna il Football Wave prima dell'uso per incrementare la velocità della palla!**  
 Always wet your Football Wave to increase ball speed!

**Più Football Waves possono essere posizionati contemporaneamente sul terreno per ottenere effetti imprevedibili**  
 You can place more than one Football Wave on the pitch to get unpredictable deflections

**Inclinazione regolabile per mezzo di due piedi telescopici**  
 Adjustable inclination by means of two telescopic feet

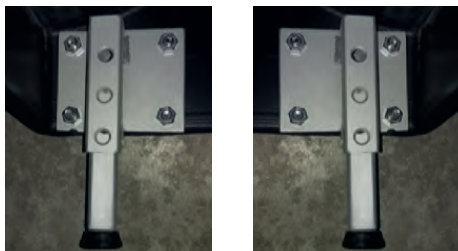

## PROPRIOCEZIONE - Equilibrium training



Art. 168PC

**Art. 168PC**  
**Tavoletta propriocettiva in plastica su emisfera, Ø cm. 41 regolabile in altezza**  
 Plastic Equilibrium Board with hemisphere bottom side Ø 41 cm. adjustable height



Art. 168PC

pg.7

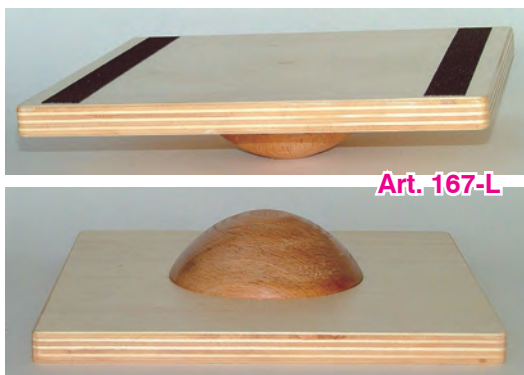

Art. 167-L

**Art. 167-L Tavoletta propriocettiva in legno su emisfera, base di appoggio cm. 30x30**  
 Wooden Equilibrium Board with hemisphere bottom side, base 30x30 cm.



**Art. IS441**  
**Tavoletta propriocettiva in legno su emisfera, con rivestimento antiscivolo Ø cm. 40**  
 Wooden Equilibrium Board with hemisphere bottom side, Ø 40 cm. base with anti-skid surface



Art. 169-R

**Art. 169-R Tavoletta propriocettiva in legno su semiluna, base di appoggio cm.60x40 con rivestimento in gomma antiscivolo**  
 Wooden Equilibrium Board, with half moon bottom side, base dimensions cm.60x40 with anti-skid surface

pg.7

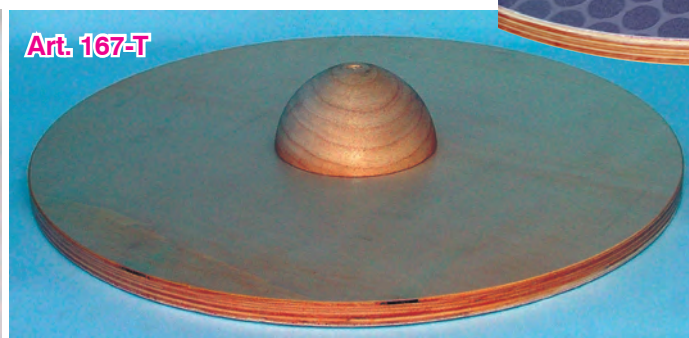

Art. 167-T

**Art. 167-T Tavoletta propriocettiva in legno su emisfera, Ø base di appoggio cm. 60 con rivestimento in gomma antiscivolo**  
 Wooden Equilibrium Board with hemisphere bottom side, base Ø 60 cm. with anti-skid surface



**Art. 169-V Tavoletta propriocettiva in vetroresina su semiluna, base di appoggio cm.60x40**  
 Fiberglass Equilibrium Board, with half moon bottom side, base dimensions 60x40 cm.



**Art. 167-V Tavoletta propriocettiva in vetroresina su emisfera, Ø base di appoggio cm. 50**  
 Fiberglass Equilibrium Board with hemisphere bottom side, base Ø 50 cm.

pg.7





**Art. MH9T / MH16T** Semisfera gonfiabile Trial per riabilitazione e stimolazione propriocettiva diam. cm. 9 o cm. 16  
Inflatable hemisphere for rehabilitation Ø 9 or 16 cm.



**Art. FTN-DB** Cuscino gonfiabile puntinato Ø cm 32,5  
Inflatable cylinder for rehabilitation Ø 32,5 cm.



**Art. FY8911** Cuscino gonfiabile puntinato Ø cm 39  
Inflatable cylinder for rehabilitation Ø 39 cm.



pg.8

Special Price



**Art. C1** Pedana Cilindrica gonfiabile Trial Skimmy per riabilitazione e stimolazione propriocettiva dim. cm.32,5x6  
Inflatable cylinder for rehabilitation dim. 32,5x6 cm.

Special Price



**Art. C2** Pedana Cilindrica gonfiabile Trial Super Skimmy per riabilitazione e stimolazione propriocettiva, dim. cm.40x9  
Inflatable cylinder for rehabilitation dim. 40x9 cm.

Special Price

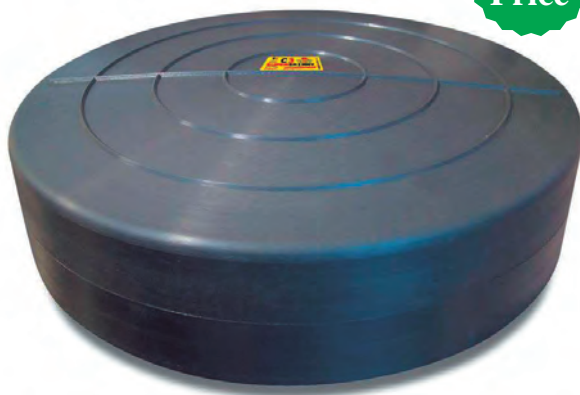

**Art. C3** Pedana Trial Super Skimmy Professional con spalla rinforzata per riabilitazione e stimolazione propriocettiva, gonfiabile cm.40x9  
Inflatable cylinder 40x9 cm. reinforced on sides



Resistenti ai tacchetti  
Stud proof





**Art. C11**  
**Pedana Rotante 1**  
 dim. cm 32,5x6  
 kg 2,8  
 (inclusa pompetta  
 per la gonfiatura)  
 Rotatory disk 1  
 pump included



**Art. C22**  
**Pedana Rotante 2**  
 dim. cm 40x10  
 kg 4  
 (inclusa pompetta  
 per la gonfiatura)  
 Rotatory disk 2  
 pump included



**Le Pedane Rotanti Trial, grazie al particolare meccanismo rotante, consentono di creare un'infinita varietà di esercizi basati su diverse posizioni di appoggio e modalità di movimento, utili a stimolare contemporaneamente il sistema vestibolare e quello visivo sensoriale, agendo quindi su tutti i sistemi di controllo del movimento sia a livello nervoso centrale che su quello spinale medio e periferico**

Rotatory Proprioceptive Disks Trial, given the particular rotating mechanism, allow a great variety of exercises based on different positions and motions, useful to simultaneously stimulate the vestibular and the sensory visual systems at both central and spinal/peripheral nervous levels

pg.8

**Art. C4**  
**Rebound Disk - diametro cm.40**  
**altezza cm.4 - Kg.1,5 colore rosso**  
 40 cm. diameter - 4 cm. thick - 1,5 Kg.

**Special Price**

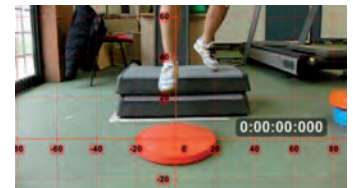

**Rebound Disk Trial è una nuova pedana ideale per allenare contemporaneamente la forza muscolare e la propriocezione. È adatta sia all'uso indoor che outdoor, anche con scarpe tecniche munite di tacchetti. In particolare, con Rebound Disk è possibile sfruttare l'altezza per effettuare esercizi combinati pliometrici (cadute ed ammortizzamento con e senza rimbalzo) e propriocettivi, consentendo all'utente un'esperienza coordinativa e di potenziamento neuromuscolare notevole. Il salto, così come la corsa, è un elemento fondamentale in moltissimi sport come calcio, pallamano, beach-handball, basket, volley, e Rebound Disk è particolarmente allenante per il salto con arresto e cambio di direzione**

Rebound Disk Trial is a new tool ideal to simultaneously train muscle strength and proprioception. It's suitable both for indoor and outdoor utilization, even with technical shoes (with studs). In particular, with Rebound Disk it's possible to exploit one's height for plyometric exercises (fall and dampen with or without rebound) and for proprioceptive ones, and the user is enabled to experience a remarkable coordination and neuromuscular strengthening. Jumping, as well as running, is a basic element in many sports such as soccer, handball, beach-handball, basketball, volleyball, and Rebound Disk is very effective in training jump with stop and direction changes

**Art. T1 Medusa Trial - struttura instabile base Ø cm. 45  
altezza cm. 23 per riabilitazione e stimolazione  
dell'equilibrio, in gomma doppio strato  
massima instabilità**

Medusa for rehabilitation  
and equilibrium training  
double stratum rubber  
base Ø 45 cm.  
height 23 cm.

**Resistente  
ai tacchetti  
Stud proof**

pg.8



**Special  
Price**

**Resistente ai  
tacchetti  
Stud proof**

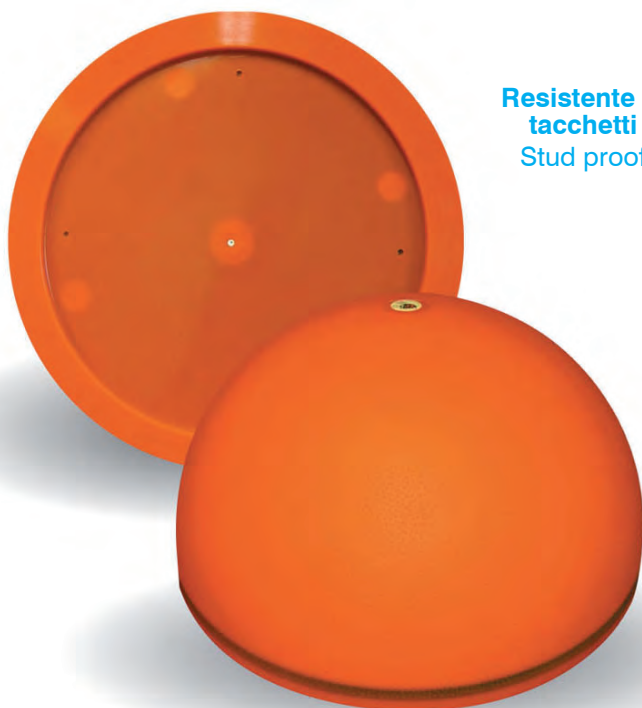

**Art. T1.1**

**Medusa Trial  
base Ø cm.45  
altezza cm. 23  
con piatto rigido  
sul fondo  
per conferire  
maggiore stabilità**

Medusa base Ø 45 cm.  
height 23 cm.  
with rigid bottom for better  
stability

pg.8

**Special  
Price**

pg.8

**Resistente ai  
tacchetti  
Stud proof**



**Art. T3**

**Pedana instabile  
con base inferiore  
antiscivolo Ø cm. 55  
altezza cm. 15  
studiata per campi sintetici,  
specifica per i più giovani**

Unstable Medusa with  
anti-skid bottom  
base Ø 55 cm.  
height 15 cm.  
ideal for artificial grass  
and young players



pg.8



**New!**

**Resistente ai tachetti**  
Stud proof

**Special Price**



**Art. T2 Tartaruga Evo Trial - struttura instabile base Ø cm. 65 altezza cm. 24 per riabilitazione e stimolazione dell'equilibrio, in gomma doppio strato**  
Tartaruga Evo double stratum rubber base Ø 65 cm. height 24 cm. for rehabilitation and equilibrium training



**Art. AHF-170**  
**Pedana BOSU Ø cm.63 - h. cm.22**  
ideale per fitness, yoga, pilates  
Bosu ball Ø 63 cm. - h. 22 cm.  
ideal for fitness, yoga, pilates

**Art. BOS**  
**Pedana BOSU Ø cm.59 - h. cm.26**  
ideale per fitness, yoga, pilates  
completa di pompa  
Bosu ball Ø 59 cm. - h. 26 cm.  
ideal for fitness, yoga, pilates  
with pump

pg.8





**Art. 995212 SOMBRERO**  
Tavoletta per ginnastica e riabilitazione che combina l'instabilità dell'imbottitura in gommapiuma sul piano di appoggio in legno con le proprietà di una semisfera gonfiabile (ad esaurimento scorte)  
Wooden Equilibrium Board with foam rubber on top and inflatable hemisphere on bottom side (until available in stock)

pg.7



**Art. 995243 ROLA BOLA**  
Tavola per l'allenamento dell'equilibrio con superficie antiscivolo - i fermi di sicurezza impediscono al cilindro di scivolare all'esterno  
Wooden Equilibrium Board with anti-skid on top  
The cylinder never slips out of the board thanks to the security wood pieces on bottom side



**Art. 14181**  
Fettuccia con lunghezza 18 metri per l'allenamento dell'equilibrio. Si fissa facilmente tra due alberi ed è perfetta per giocare, allenarsi o fare riabilitazione. Kit completo con sacca e paraalberi  
18 meter long tape for balance training. It is easily fixed between two trees and is perfect for playing, training or rehab. Complete kit with bag and tree protections

pg.8



**Art. TBEFS**  
BLOCCO PER STRETCHING tendineo e muscolare (flessori caviglia e coscia, dorso etc.) con appoggio soffice e sagomato a 2 inclinazioni ideale per il defaticamento e per il recupero  
STRETCHING BLOCK for ankle, leg, back muscles and tendons - with soft double inclination very good for after-training exercises



**Art. V9178**

**Plinto per pliometria regolabile in altezza da cm. 30 a cm. 45 in tubolare di acciaio zincato piano di appoggio in legno multistrato dim. cm.150x30**  
 Plyometric bench adjustable heights (from 30 to 45 cm.) in galvanized steel wooden board dim. 150x30 cm.



**Art. 1PP40/2PP40/3PP40  
1PP50/2PP50/3PP50**

**Panca per pliometria in acciaio verniciato, lunghezze disponibili: cm. 100 / cm. 200 / cm. 300 larghezza cm. 35 altezze disponibili: cm. 40 / cm. 50 piano di appoggio in legno rivestito in gomma antiscivolo**

Plyometric bench in painted steel, available length 100 / 200 / 300 cm. width 35 cm. available height 40 / 50 cm. board made of wood with anti-skid rubber cover



**New!**



**Art. S3PP Set 3 piattaforme pliometriche con 3 diverse altezze: cm. 30, cm. 45 e cm. 60 rivestimento antiscivolo sulla parte superiore e cuscinetti in gomma sotto ciascuna piattaforma per una maggiore sicurezza - impilabili per un pratico stoccaggio**

Set of 3 plyometric platforms with 3 different heights: 30 cm., 45 cm. and 60 cm. Anti-skid coating on top and rubber pads under each platform for added safety. Stackable for practical storage



**Art. AHF-140**

**Parallelepipedo per pliometria in legno cm. 76x61x51 utilizzabile a 3 diverse altezze**  
 Wooden plyometric box 76x61x51 cm. 3 different heights



**Art. AHF-255**

**Parallelepipedo per pliometria in legno cm. 76x61x51 utilizzabile a 3 diverse altezze con finitura antiscivolo**  
 Wooden plyometric box 76x61x51 cm. 3 different heights anti-skid treatment



**Art. AHF-164**

**Parallelepipedo per pliometria in legno cm. 76x61x51 utilizzabile a 3 diverse altezze con imbottitura in EVA sp. cm. 2**  
 Wooden plyometric box 76x61x51 cm. 3 different heights EVA padding 2 cm. thickness

● pg.10

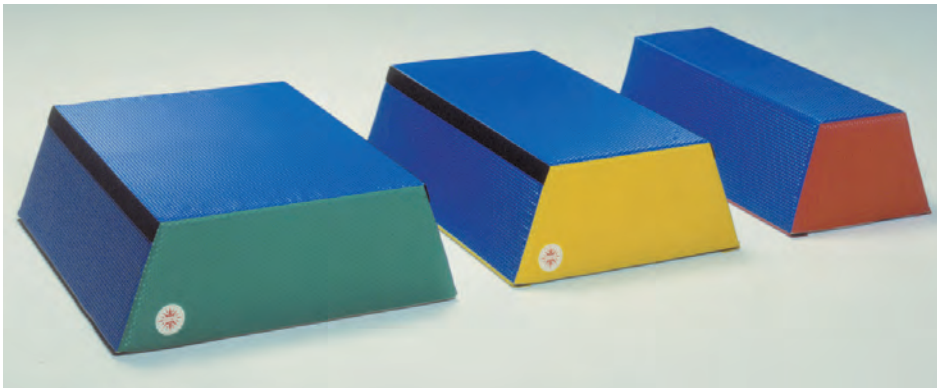

**Art. PAV2 Set 3 plinti soft a basi rettangolari in gommapiuma rivestita con PVC ignifugo Cl. 1, sovrapponibili - 3 altezze ottenibili: cm. 30, cm. 60, cm. 90**  
 Set of 3 rectangular base soft steps - by placing them one upon the other you can get 3 different heights: 30, 60, 90 cm.



**Art. VCU60 / VCU70 / VCU80**

**Cubo per pliometria in legno verniciato al naturale con gomma antiscivolo sui piani di appoggio lato cm. 60/70/80**  
 Wooden plyometric cube with anti-skid rubber 60/70/80 cm. side

## TRAMPOLINI - Trampolines



**Art. 166**  
Trampolino elastico Ø cm. 97  
Trampoline Ø 97 cm.



**Art. TF-03**  
Trampolino elastico Ø cm. 122  
pieghevole - 40 molle  
Trampoline Ø 122 cm.  
foldable - 40 springs

pg.7

**Art. V1709**  
Trampolino elastico  
ad altezza fissa  
dim. cm.125x125  
Trampoline 125x125 cm.  
reinforced

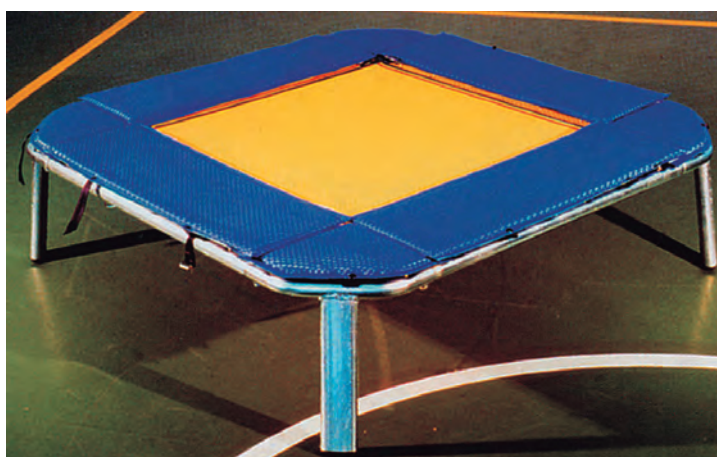

**Art. S01154**  
Trampolino elastico  
ad inclinazione  
regolabile  
completo di protezioni  
dim. cm. 125x125  
Trampoline  
size 125x125 cm.  
adjustable inclination  
with soft perimetric  
protection

**Art. TRO-9**  
Trampolino da esterno Ø cm. 305  
con rete di protezione perimetrale  
Outdoor trampoline Ø 305 cm.  
with perimetric protection net



## SCALE - CERCHI - CORDE - Speed Ladders - Hoops - Jumping Ropes

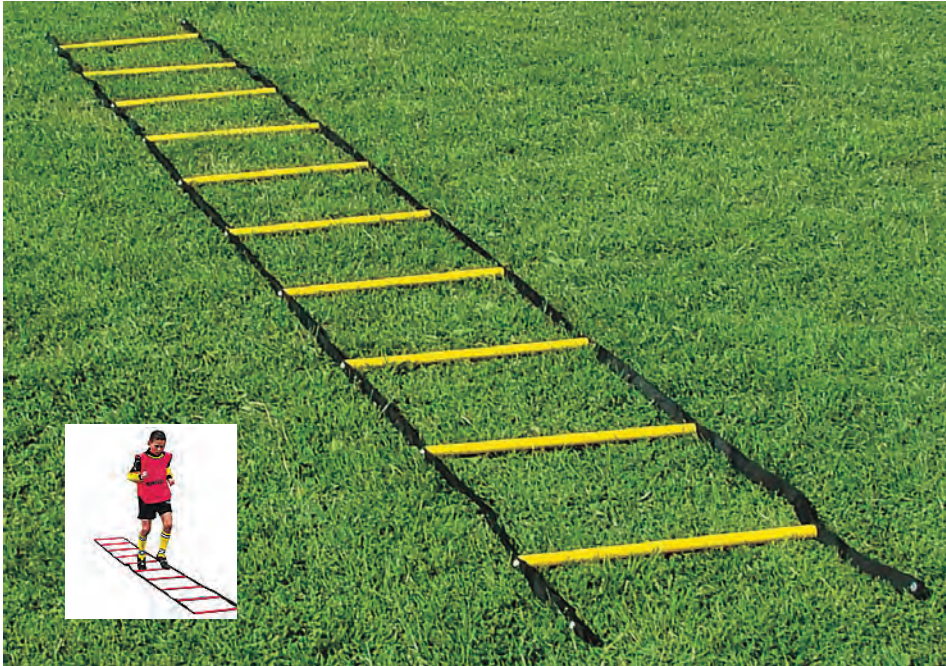

### Art. SL4

Scala lunghezza m. 4  
con 10 pioli rotondi  
per esercizi di  
coordinazione motoria  
(compresa sacca  
per il trasporto)

Speed ladder length 4 meters  
with 10 tubular rungs for quick  
step and coordination  
exercises, bag included

pg.9

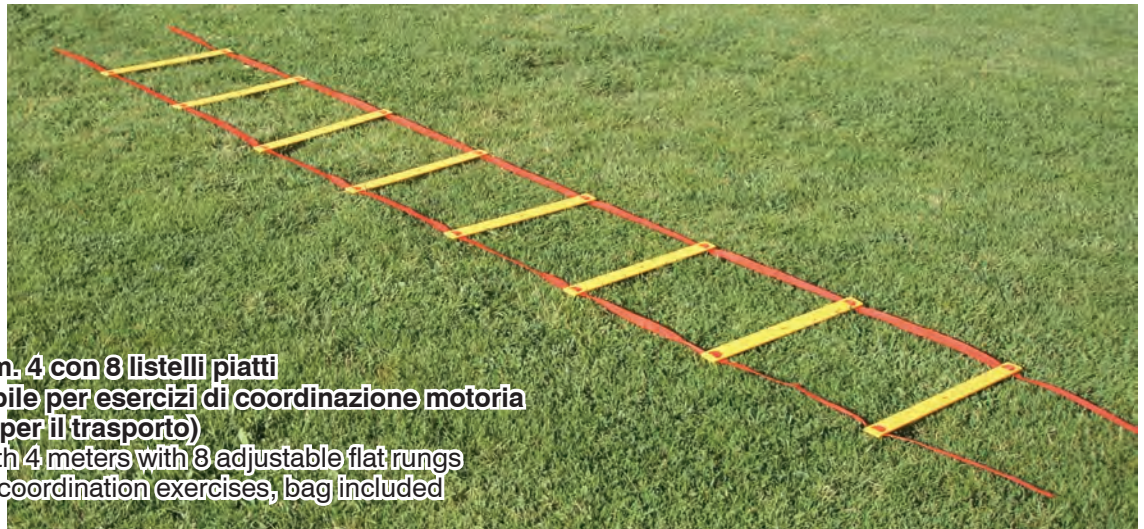

### Art. SL4LP

Scala lunghezza m. 4 con 8 listelli piatti  
a distanza regolabile per esercizi di coordinazione motoria  
(compresa sacca per il trasporto)

Speed ladder length 4 meters with 8 adjustable flat rungs  
for quick step and coordination exercises, bag included



### Art. SL6

Scala lunghezza m. 6  
con 12 listelli piatti a distanza regolabile  
(compresa sacca per il trasporto)

Speed ladder length 6 meters  
with 12 adjustable flat rungs,  
bag included



**Art. S4DB**  
**Scala doppia lunghezza m. 4  
con 20 listelli piatti a distanza regolabile  
per esercizi di coordinazione motoria  
(compresa sacca per il trasporto)**  
Double speed ladder length 4 meters with  
20 adjustable flat rungs for quick step and  
coordination exercises, bag included

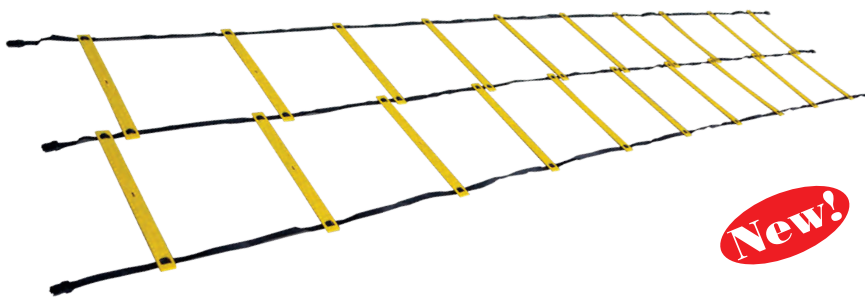

**Art. SK.ELD**  
**ELEVATION LADDER**  
**Scaletta cm. 213 trasformabile in serie di 6 ostacoli h. cm. 10**  
Switch between a flat ladder and a series of 6 hurdles h. 10 cm.

**Art. B704086**  
**Scala in plastica flessibile lunghezza m.4 con 10 pioli spessore cm.1,5  
dimensione quadri cm.40x40 pieghevole con rimessaggio  
(ad esaurimento)**  
Flexible speed ladder length 4 meters in plastic pipes 1,5 cm. thick - foldable with holder  
(until available)



pg.9



**Art. 701411**  
**Minibirillo concavo altezza cm. 9  
per sollevamento scala Art. B704086  
(ad esaurimento)**  
Cone 9 cm. height carved on top for  
Art. B704086 underneath support  
(until available)

**Art. K4111**  
**Kit scala Art. B704086  
+ 20 Minibirilli Art. 701411  
(ad esaurimento)**  
Kit Art. B704086 + 20 x Art. 701411  
(until available)



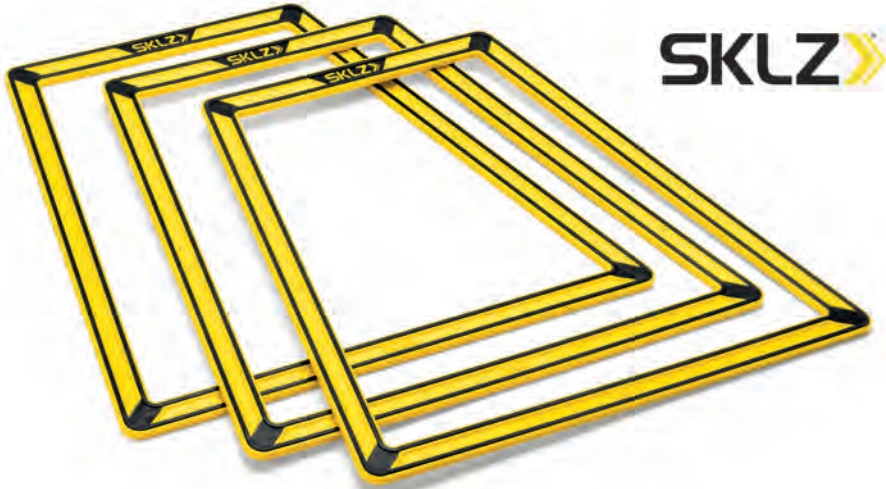

**SKLZ**

**Esempi di combinazioni possibili**  
A few examples

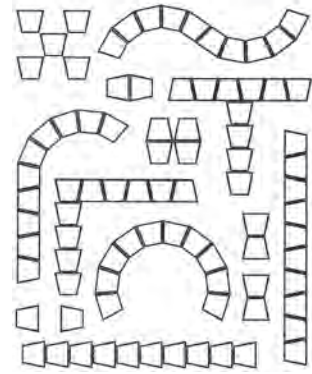

**Art. SK.ATP**

**AGILITY TRAINER PRO - set 10 TRAPEZOIDI componibili per allenamento agilità e coordinazione multidirezionale, e per il miglioramento della velocità e dei tempi di reazione**

Agility Trainer Pro - customizable footwork and agility trainer designed for curvilinear and alternative training patterns, cuts your reaction time while adding speed in all directions. Set of 10 trapezoids with a carry handle



Con questo nuovo strumento di allenamento creativo si possono incrementare le doti di rapidità, agilità e potenza nei cambi di direzione e nelle traiettorie curvilinee che gli atleti sono chiamati ad effettuare durante la gara. Questi speciali trapezi sono molto stabili su ogni tipo di terreno, permettendo così un esercizio senza interruzioni



Sports don't happen in a straight line, now neither does your training. The Agility Trainer Pro lets you recreate the curvilinear and broken patterns that take place in sports, helping you set up your cuts, turns and changes of direction. It lets you add the multi-directional quickness and precise footwork that can quickly change the game. The Agility Trainer Pro won't slip, slide or otherwise interrupt your training sessions

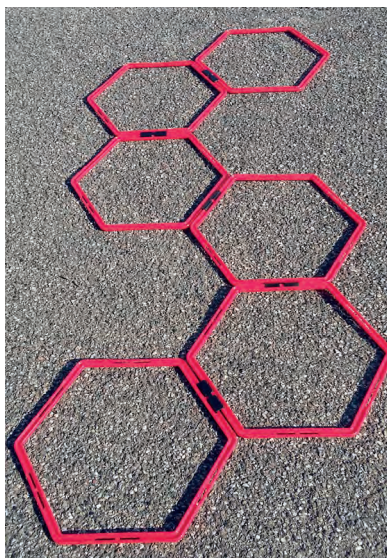
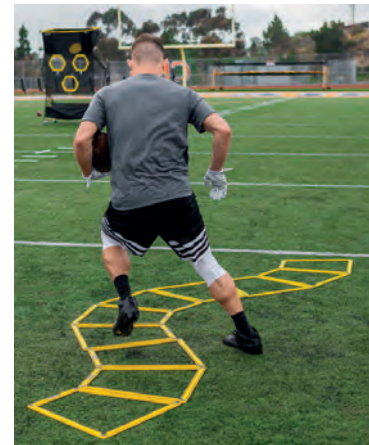

**Art. HEXS6** Set 6 esagoni in plastica componibili dim. cm.45x53 (altezza, larghezza) lato cm.28, completi di clip e borsa colori: giallo, verde, rosso, azzurro

Set of 6 modular plastic hexagons 45x53 cm. (height, width) complete with clips and bag - colors: yellow, green, red, royal

● pg.9

**Video dimostrativo disponibile su [www.barretsport.com](http://www.barretsport.com)**  
Video available on [www.barretsport.com](http://www.barretsport.com)

**Art. SQ15**

**15 SQUARES**

Telaio di cm. 300x200 in alluminio Ø mm.32

6 elastici con velcro consentono di formare 15 quadri per esercizi di coordinazione, reattività, riscaldamento e potenziamento muscolare con piedi di sostegno intercambiabili utilizzabile alle seguenti altezze dal terreno: cm.0 / cm.20 / cm.40 / cm.60  
kit completo di borsa per il trasporto e di 6 elastici di ricambio (che consentono eventualmente di formare un numero maggiore di quadri)

Aluminium frame 300x200 cm. pipe Ø 32 mm. equipped with 6 elastic bands with velcro forming 15 squares for warm up, coordination, reactivity and jumping exercises with interchangeable sets of support feet adjustable at the following heights from ground: 0 cm. / 20 cm. / 40 cm./ 60 cm. with carrying bag and 6 additional spare elastics (which eventually allow you to form a greater number of squares)

**Art. SQ15.NS**

**Set 6 elastici con velcro di ricambio**

Set of 6 spare elastics with velcro



h. cm. 60

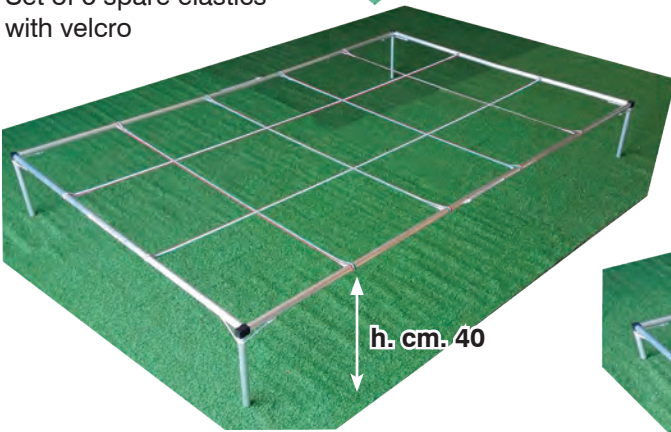

h. cm. 40

pg.9



h. cm. 20

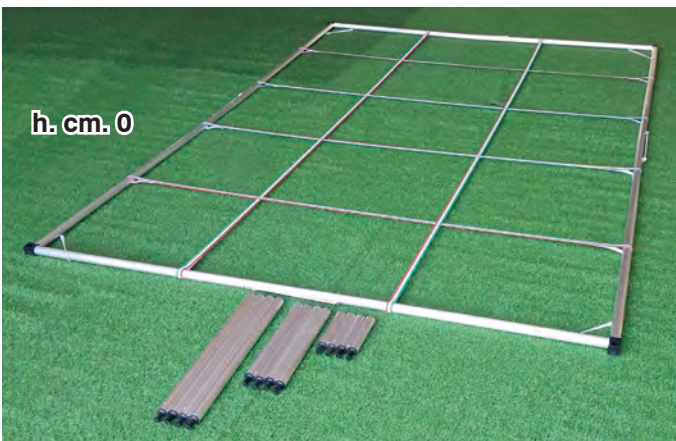

h. cm. 0



Morbidi elastici flessibili fino a terra  
Soft elastic bands flexible down to the ground

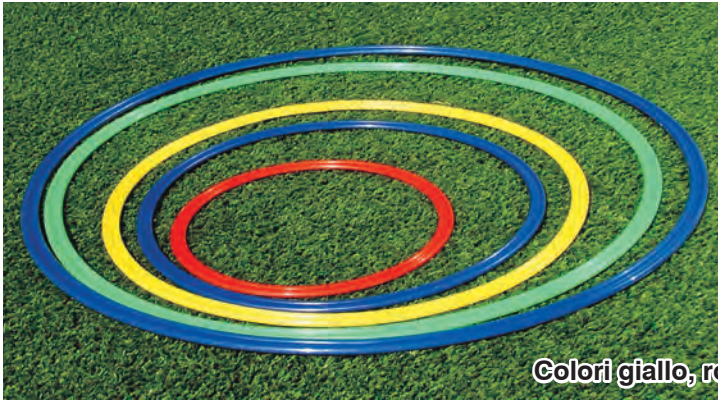

Colori giallo, rosso, blu e verde

**Art. CNP30 / CNP40 / CNP50 / P00181 / P00191 / P00201**  
**Cerchio in nylon piatto Ø cm. 30 / 40 / 50 / 60 / 70 / 80**  
 Flat Nylon Hoop Ø 30 / 40 / 50 / 60 / 70 / 80 cm.



**Art. P00182 / P00192 / P00202 / P00212**  
**Cerchio in PVC tubolare Ø cm. 60 / 70 / 80 / 90**  
 Tubular PVC hoop Ø 60 / 70 / 80 / 90 cm.



**Art. S00402/S00405/S00406**  
**Bastone in legno**  
 cm. 80-100-120  
 80-100-120 cm. Wooden Stick

**Art. E21**  
**Bastone in PVC cm.120**  
 120 cm. PVC Stick

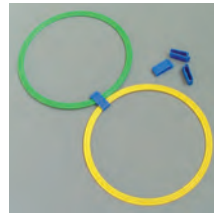

**Art. OCC11**  
**Connettore per cerchi piatti**  
 Flat Hoop Connector



pg.8

**Art. S00472**  
**Mensola porta cerchi a parete in acciaio verniciato**  
 Hoop wall Holder in painted steel

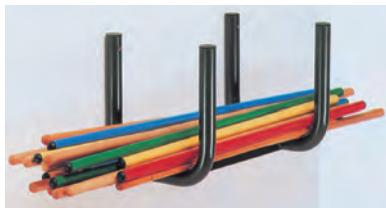

**Art. S00414**  
**Mensola porta bastoni a parete in acciaio verniciato**  
 Stick wall Holder in painted steel



**Art. 043**  
**Corda per salto in canapa con manici in legno ed ingrossamento centrale**  
 Hemp Skipping Rope with hardwood handles, thicker in the middle section



**Art. CS1**  
**Corda per salto in canapa con ingrossamento centrale senza manici**  
 Hemp Skipping Rope thicker in the middle without handles

pg.8

**Art. 043P**  
**Corda per salto in nylon con manici in legno**  
 Nylon Skipping Rope with hardwood handles

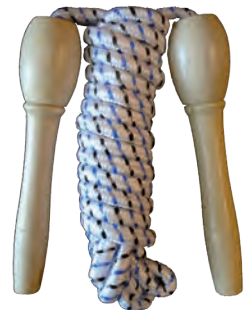

**Art. AHF-017**  
**Corda per salto in PVC con manici soft touch e cuscinetti a sfera**  
 PVC Skipping Rope with soft handles and ball bearings

**Art. AHF-102**  
**Corda per salto veloce in acciaio con manici in plastica e cuscinetti a sfera (lunghezza regolabile)**  
 Steel Skipping Rope with plastic handles and ball bearings (adjustable length)



**Art. 043L** Corda per salto in pelle  
 Leather Skipping Rope with hardwood handles



**Art. STAR**  
**Starkick completo di cintura e corda elastica per allenamento ai palleggi ed al tocco di palla (pallone escluso)**  
 Starkick with belt and elastic rope for ball kick and control training (ball not included)



pg.10

**Art. PTI.15070**  
**Soccer Ball Trainer completo di pallone, corda elastica di m. 12,5 e ancoraggio**  
 Soccer Ball Trainer with ball size 5 in TPU, rubber base, 12,5 m. elastic rope and 1 peg



**Art. OTK**  
**Training Kicker con corda non elastica per allenamento ai palleggi ed al tocco di palla (pallone escluso)**  
 Training Kicker with non elastic rope for ball kick and control training (ball not included)

pg.9



**Art. TIM.SP**  
**Supporto per Tackle Improver**  
 Holder for Tackle improver

**Art. TIM**  
**Tackle Improver per allenamento al contrasto**  
 For tackle training

Uno strumento innovativo per migliorare la tecnica di esecuzione e la potenza del contrasto. Il Tacke Improver indirizza il piede d'appoggio verso la posizione più idonea per esprimere la maggiore potenza d'impatto. Potenzia inoltre tutte le catene muscolari che intervengono nel contrasto, ma senza causare traumi, grazie ad una speciale molla collegata al pistone che sorregge il pallone.

*Very useful training device for strengthening all muscles involved in tackling. Absolutely safe, thanks to a spring and piston system that avoids injuries.*

pg.10



pg.9

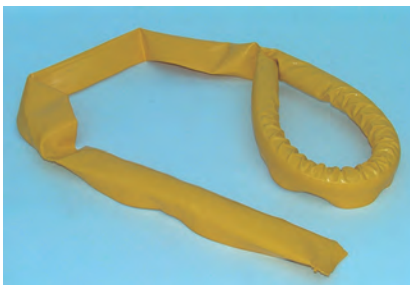

**Art. CVCO**  
**Cavigliera Coordinativa con contrappeso, migliora l'equilibrio e l'indipendenza psicomotoria delle gambe, ed in particolare ammorbidisce la gamba dominante migliorandone la sensibilità del piede**  
 Rotating ankle, with weight, to improve equilibrium and leg independence: in particular it softens the dominant leg improving sensibility of the non dominant foot



**Video dimostrativo disponibile su [www.barretsport.com](http://www.barretsport.com)**  
 Video available on [www.barretsport.com](http://www.barretsport.com)

## ALLENAMENTO SOTTO CARICO E FUNZIONALE - Training with weights



**Art. ASN**

Cintura in pelle sintetica con velcro completa di corda, catena e moschettoni **di ricambio** per slitta Art. SLD  
Synthetic leather belt, rope and chains spare for Art. SLD



**Art. SLD**

**Art. SLD** Slitta per il miglioramento della capacità di accelerazione tramite il traino a carico variabile completa di cintura in pelle sintetica con velcro, corda e moschettoni (dischi in ghisa non inclusi)  
Sledge (weights not included) improving acceleration with synthetic leather belt, rope and chains

**Art. CBV**

Cintura in pelle sintetica con velcro **di ricambio** per Art. SLD  
Synthetic leather belt w/velcro spare for Art. SLD



pg.9



**Art. SK.SPSC**  
**SPEED SAC - sacca di traino con pesi munita di cintura e moschettoni utilizzabile anche indoor o su superfici sintetiche**  
Improves overall speed and explosiveness, boosts acceleration and stride length. Adjustable weight options for variable resistance portable and versatile to be used anywhere



In dotazione 3 sacchi di capacità Kg. 4,5 da riempire con sabbia  
Includes 3 x 4,5 Kg. sacs to be filled with sand



**Art. 045 / AHF-112 / AHF-113**  
**Giubbino caricabile con pesi fino a Kg.10-20-30 (pesi inclusi)**  
Jacket Weighted up to 10-20-30 Kg. (weights included)



**Art. PCH**  
**Paracadute per potenziamento della corsa**  
Parachute to improve the power of your run

pg.9

**Art. TBB2 / ... / TBB6**  
**Body Bar**  
Kg. 2-3-4-5-6 per  
allenamento funzionale  
con pesi liberi  
Body Bar  
2-3-4-5-6 Kg.  
for functional training  
with free weights



pg.12



**Art. 991310M/991311M/991312M**  
**Shoulder Bag**  
con 3 impugnature  
pesi disponibili Kg. 10-15-20  
Shoulder Bag with  
3 handles  
weights available 10-15-20 Kg.

pg.9

**Shoulder Bag kg. 5 e kg. 12**  
**disponibili fino ad esaurimento scorte**  
Shoulder Bag 5 kg. and 12 kg.  
until available



**Art. APBG-5/APBG-10/APBG-15/  
APBG-20/APBG-25**  
**Borsa zavorrata**  
con 6 impugnature  
pesi disponibili Kg.5-10-15-20-25  
Heavy Bag with 6 handles  
weights available 5-10-15-20-25 Kg.

pg.9

**Art. WBG**  
**Borsa gonfiabile zavorrata con acqua a peso variabile**  
(capacità da 5 a 25 litri) lunghezza cm. 90 con 4 maniglie  
consente nuovi esercizi di forza coordinata  
grazie alla massa oscillante interna - pompa inclusa  
Inflatable bag with water inside (from 5 up to 25 liters), length 90 cm.  
with 4 handles, allows new exercises for muscle strength thanks to  
the dynamic weight inside - pump included

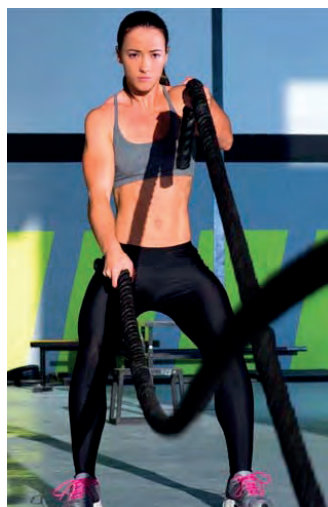

**Art. BR-3812 / BR-5015**  
**Fune da allenamento**  
**Battle Rope**  
ø mm 38 lunghezza mt. 12  
oppure  
ø mm 50 lunghezza mt. 15  
**Battle Rope**  
12 meters - 38 mm. thick or  
15 meters - 50 mm. thick

pg.9



**In poliestere intrecciato con impugnature rivestite in gomma termoretraibile**  
**ideale per il potenziamento dei muscoli di spalle e avambracci,**  
**ottimo allenamento cardiorespiratorio**  
Polyester encased rope with shrink-wrap handles, perfect for strengthening shoulders  
and forearm muscles, excellent cardio-respiratory workout

## FUNCTIONAL TRAINING



pg.9

**FT.IST**  
**Functional Training**  
**Attrezzo polifunzionale**  
**per il potenziamento della catena estensoria**  
**e flessoria degli arti superiori e inferiori**  
 Functional Training multi-purpose  
 belt for the enhancement  
 of the extension and flexion muscular  
 chains of the upper  
 and lower limbs



**FST-DBL**

**Functional Training Double Pro**  
**Attrezzo professionale per allenamento**  
**in sospensione con maniglie svincolate**  
**utilizzabili separatamente**  
 Functional Training with free handles to be used also  
 separately - steel snap hooks and rings



**MTLTX**  
**Lacci di Trazione**  
 Traction Laces

pg.9

**PLTRZ**  
**Prolunga**  
**per Lacci**  
**di Trazione**  
 Extension for  
 Traction Laces



**Attrezzo polifunzionale per il potenziamento della catena estensoria e flessoria degli arti superiori e inferiori**  
 Multi-purpose belt for the enhancement of the extension and flexion muscular chains of the upper and lower limbs



**Art. DTL15**  
**Lacci di Trazione**  
**dinamici**  
**con carrucola**  
 Dynamic functional  
 training with pulley



## BANDE ELASTICHE - BOA - Elastic Bands



pg.11

- Art. MBLT** MINI BAND LIGHT in poliestere ø cm.20,70 h.mm.50
- Art. MBME** MINI BAND MEDIUM in poliestere ø cm.18,80 h.mm.50
- Art. MBST** MINI BAND STRONG in poliestere ø cm.19,10 h.mm.50
- Art. MBEX** MINI BAND EXTRA STRONG in poliestere ø cm.19,10 h.mm.54

Polyester Mini Bands



**Art. 991707 / 991708 / 991709**

- SET 10 ELASTICI AD ANELLO colore giallo (morbido) rosso (medio) - verde (resistente) Ø cm. 27,50**
- Set of 10 Elastic Rings yellow (soft) red (medium) - green (hard) Ø 27,5 cm.



- Art. AHF-141**
- Coppia maniglie per fitness band**
- Pair of handles for fitness band

- Art. IFBG**
- Fitness band cm. 175x15 colore giallo**
- Yellow fitness band

- Art. IFBR**
- Fitness band cm. 175x15 colore rosso**
- Red fitness band

- Art. IFBB**
- Fitness band cm. 175x15 colore blu**
- Blue fitness band

- Art. IFBN**
- Fitness band cm. 175x15 colore nero**
- Black fitness band

pg.12



- Art. AHF-251/AHF-128/AHF-129**
- AHF-130/AHF-131/AHF-132**
- Elastico ad anello POWER BAND**
- circonferenza cm. 208 spessore mm. 4,5**
- larghezza arancio mm. 6,4 - rosso mm. 13**
- nero mm. 22 - viola mm. 29 - verde mm. 45 - blu mm. 64**
- Power Band elastic circumference cm.208 - 4,5 mm. thick
- orange 6,4 mm. width - red 13 mm. width
- black 22 mm. width - violet 29 mm. width
- green 45 mm. width - blue 64 mm. width



- Art. RLEV**
- Rotolo lattice verde per esercizi muscolari,**
- larghezza cm. 15, lunghezza mt. 25**
- spessore 0,3 mm.**
- Elastic green Band for muscle exercises,
- 15 cm. wide, 25 meter long, thick 0,3 mm.

pg.11



- Art. RLEF**
- Rotolo lattice fucsia per esercizi muscolari,**
- larghezza cm. 15, lunghezza mt. 25**
- spessore 0,4 mm.**
- Elastic fuchsia Band for muscle exercises,
- 15 cm. wide, 25 meter long, thick 0,4 mm.



- Art. RLEB**
- Rotolo lattice blu per esercizi muscolari,**
- larghezza cm. 15, lunghezza mt. 25**
- spessore 0,5 mm.**
- Elastic blue Band for muscle exercises,
- 15 cm. wide, 25 meter long, thick 0,5 mm.



**Art. KER-IS**

Set 5 elastici con 5 diverse resistenze dotati di ganci metallici da entrambi i lati. Completo di 1 coppia di maniglie, 1 coppia di cavigliere, 1 accessorio per bloccare l'elastico contro una porta e utilizzare un arto per volta, 1 sacca  
 Set of 5 elastic bands with 5 different resistances equipped with metal hooks on both sides. Complete with 1 pair of handles, 1 pair of ankle bands, 1 accessory to lock the elastic against a door and use one limb at a time, 1 bag

Here are some examples of the door anchor in action:

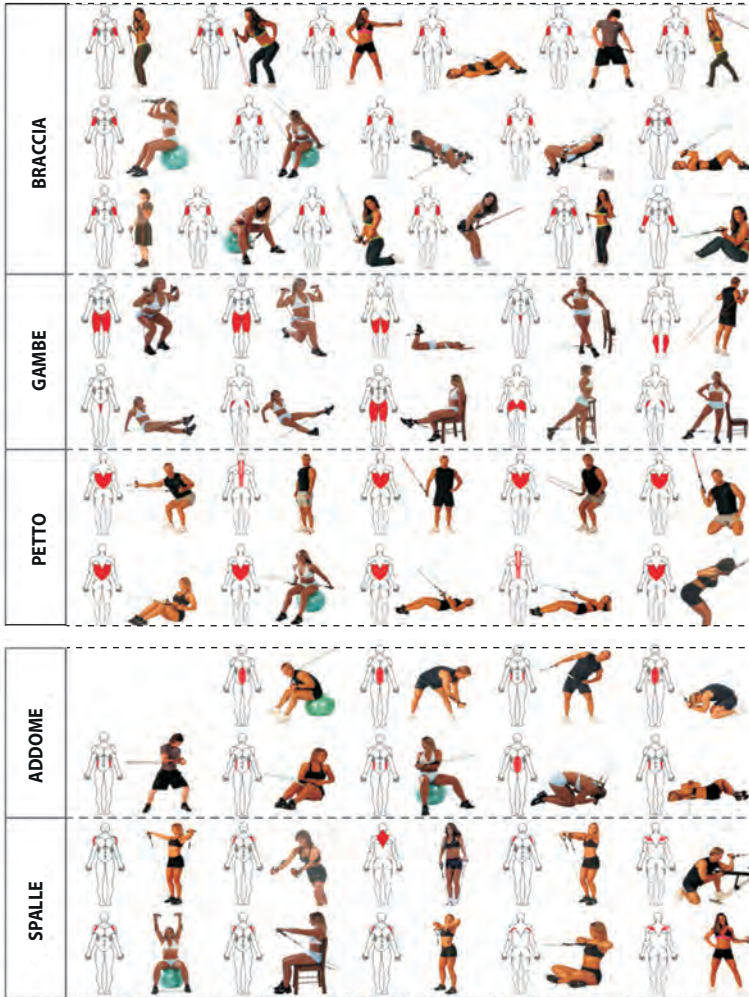

GANCIO SU 1 ELASTICO GANCIO SU 2 ELASTICI GANCIO SU 3 ELASTICI GANCIO SU 4 ELASTICI GANCIO SU 5 ELASTICI



COLORE ELASTICO	LIVELLO DI RESISTENZA	LIVELLO DI RESISTENZA	DIMENSIONI
GIALLO	EXTRA LEGGERO	2,7 kg - 3,6 Kg	5X8X1100MM
VERDE	LEGGERO	4 kg - 5 Kg	6X9X1100MM
ROSSO	MEDIO	5,5 kg - 6,75 Kg	5X9X1100MM
BLU	FORTE	6,75 kg - 9 Kg	5X10X1100MM
NERO	EXTRA FORTE	9,45 kg - 11,25 Kg	6X11X1100MM

1. Your resistance bands come in 5 different resistance levels, noted by a different band color. Please refer to the table for more information on the levels of resistance
2. You can use any or all of the bands at one time during your workouts
3. Attach one end of the band(s) to the foam handles or ankle straps and same on the other end
4. The door anchor will attach anywhere on a standard door, including the bottom of the door. To use the door anchor, ensure the bigger end is attached to the apposite side of door and feed the thin end through. Once the thin end is through you can feed the exercise band through it. Ensure the door is fully closed before performing any exercise

Resistance Band Color	Resistance level	Resistance level	Dimensions
Yellow	X- Light	6lbs - 8lbs	5X8X1100MM
Green	Light	9lbs - 11lbs	6X9X1100MM
Red	Medium	12lbs - 15lbs	5X9X1100MM
Blue	Heavy	15lbs - 20lbs	5X10X1100MM
Black	X-Heavy	21lbs - 25lbs	6X11X1100MM

pg.11



**Art. PTI.SPS**

Slide Pads - paio di slide pads utilizzati per esercizi di scivolamento di mani e piedi volti al miglioramento della flessibilità e della forza muscolare  
 Conditioning tool to improve flexibility, shaping and core strength, simulates many slide board exercises  
 Set of 2 pcs



**Art. 991710/ ... /991738**  
**Elastico tubing con maniglie**  
**colore rosso, giallo, viola, nero**  
 Elastic with handles  
 red, yellow, violet, black color



**Art. 991714/ ... /991742**  
**Elastico tubing mt.10 senza maniglie**  
**colore rosso, giallo, viola, nero**  
 10 meter elastic without handles  
 red, yellow, violet, black color



pg.11



**Art. AHF-167**  
**Elastico tubolare con guaina**  
**e maniglie light cm.150x15**  
**spessore mm. 0,35**  
 Light elastic tube with sheath  
 and handles 150x15 cm.  
 thickness 0,35 mm.

**Art. AHF-168**  
**Elastico tubolare con guaina**  
**e maniglie medium cm.150x15**  
**spessore mm. 0,50**  
 Medium elastic tube with sheath  
 and handles 150x15 cm.  
 thickness 0,50 mm.

**Art. AHF-169**  
**Elastico tubolare con guaina**  
**e maniglie strong cm.150x15**  
**spessore mm. 0,65**  
 Strong elastic tube with sheath  
 and handles 150x15 cm.  
 thickness 0,65 mm.



**Art. AHF-068**  
**Set 3 elastici tubing con maniglie**  
**tre differenti livelli di resistenza**  
**impugnature ergonomiche soft touch**  
**per esercizi arti superiori e inferiori**  
**completo di borsa in microrete**  
 Set of 3 elastics with soft touch handles  
 3-level resistance, bag included  
 tones and strengthens  
 arms, legs, gluteus, abdominals,  
 shoulders and chest muscles

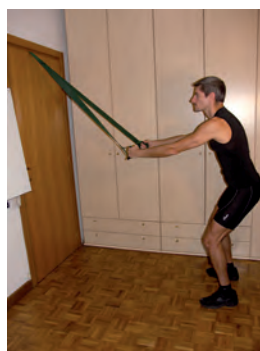

pg.10

**Art. ARS.3**  
**Banda Elastica rinforza spalle - può essere usata in ogni luogo che abbia un appiglio per la chiusura**  
**a velcro (anche in casa o in albergo) grazie alla presenza di uno spessore che, a porta chiusa,**  
**non fa scivolare l'attrezzo e non danneggia la porta**  
 Elastic Band for shoulder injury training exercises

**Art. 016824**

**ELASTICO BOA in gomma para mm. 7x18 rivestito con guaina di sicurezza lunghezza mt. 3 con un moschettone a ciascuna estremità, resistenza Kg. 50**

Rubber BOA 7x18 mm. with safety sheath 3 meter length, resistance 50 Kg.

pg.11



**Art. 016827**

**Paio polsini per elastico BOA**

Pair of wristbands for BOA exercises

Si suggerisce l'utilizzo dell'elastico BOA con una cintura o con un altro tra gli accessori disponibili

Utilization of rubber Boa is suggested with a belt or with another available accessory



**Art. 016828**

**Paio cavigliere per elastico BOA**

Pair of anklebands for BOA exercises

**Art. 016825**

**CINTURA Junior da agganciare a elastico BOA diametro max cm.105**

Junior Belt for BOA traction - max diameter 105 cm.

**Art. 016826**

**CINTURA Senior da agganciare a elastico BOA diametro max cm.140**

Senior Belt for BOA traction - max diameter 140 cm.

pg.11



**Art. 016829**

**Pettorina per elastico BOA**

Shoulder belt for BOA exercises



**Art. C3005**

**Staffa per ancoraggio elastico BOA a parete**  
BOA wall anchor bracket



Anello scorrevole  
"free-floating" ring



**SKLZ**

pg.11

**Art. SK.R360**

**RECOIL 360 - elastico con cintura ad anello scorrevole utilizzabile in autonomia o con l'aiuto del preparatore resistenza Kg. 22**

Maximizes power, speed and vertical jump Engineered with a "free-floating" ring for 360 degrees of movement

Designed for solo use or for training with a partner resistance 22 Kg.

**DYNAMIC RESISTANCE / ASSISTANCE TRAINER**



**Art. SK.ACTR**

**ACCELERATION TRAINER**

per l'allenamento della velocità in ogni direzione, dell'accelerazione e della velocità massima

Da utilizzare con l'aiuto del preparatore

Trains speed in every direction

Builds speed and power from the start, during acceleration and at the top-end

Designed for training with a partner



pg.11

**DYNAMIC OVERLOAD AND RELEASE SYSTEM**



Anello scorrevole "free-floating" ring



**Art. SK.LRP**

**LATERAL RESISTOR PRO**

Attrezzo per migliorare la velocità del primo passo e la rapidità laterale con elastici tubolari intercambiabili a diversa resistenza

Develops first-step quickness and lateral speed

Patented Slide-Lock system for quick, safe switching of resistance cables



**STRENGTH AND SPEED TRAINER**

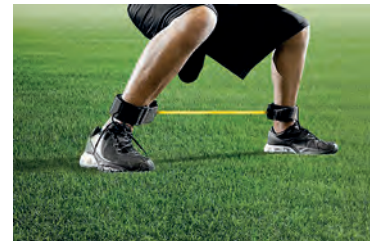

pg.10

**VERTICAL JUMP TRAINER**



**Art. SK.HPZ**

**HOPZ 2.0**

Attrezzo per migliorare la forza e la potenza dei muscoli impegnati nell'elevazione, con elastici tubolari intercambiabili a diversa resistenza

Builds explosive leg power and strengthens jumping muscles

You can move resistance cables on belt to target specific muscles and change resistance cable quickly





**Art. AE**  
**Banda elastica**  
**Antonelast**  
**per esercizi di**  
**stretching e**  
**potenziamento**  
**muscolare**  
 Elastic band for  
 body muscle  
 exercises



**Con velcro cucito su**  
**entrambe le estremità**  
**with velcro seamed at**  
**both sides**



pg.10



**Art. RA**  
**Rinforza Abduttori**  
 Elastic band for  
 abductor muscles

**Con velcro cucito su**  
**entrambe le estremità**  
**with velcro seamed at**  
**both sides**



**Art. OSI**  
**Over Speed Improver - Tramite questa cintura elastica l'atleta più veloce**  
**trascina il più lento, incrementando contemporaneamente la velocità di entrambi**  
 By this elastic belt the quicker player pulls the slower player, increasing both athletes' speed



**Con velcro cucito su**  
**entrambe le estremità**  
**with velcro seamed at**  
**both sides**

pg.11



**Art. PSR**  
**Power Speed**  
**Resistor**  
**per potenziamento**  
**della corsa**  
**esercizio in coppia**  
**(nylon non elastico)**  
 To improve explosive  
 force - two people  
 involved (non elastic  
 band)



**Art. EPW**  
**Elastic Power**  
**2 fasce con cintura**  
**in pelle**  
**incrementa**  
**la forza esplosiva**  
**potenziando la**  
**muscolatura delle**  
**gambe e del dorso**  
 2 Bands with leather belt  
 for explosive strength  
 improvement, for leg and  
 back muscle training

pg.11



**Art. SRE**

**Speed Reaction**

**Allenamento dei riflessi e della reattività**  
(l'elastico non si sgancia se il difensore perde contatto dall'attaccante)

Reflex and reactivity training device (the belt does not separate if the defender loses contact)



**Cintura elastica**  
Elastic belt

pg.11



**Cintura non elastica**  
Non elastic belt

**Art. EB**

**Evasion Belt - Allenamento dei riflessi e della reattività ideale per marcature a uomo**  
(la cintura si sgancia se il difensore perde contatto dall'attaccante)

Reflex and reactivity training device, for man to man coverage (the defender loses contact)



**Art. RIM**  
**Reaction Improver**  
per l'allenamento della reazione allo stimolo visivo in percorsi ad ostacoli, ideale per marcature a uomo

(l'elastico si stacca se si perde contatto)  
Elastic Belt for visual reflex training in drill sections, for man to man coverage (the elastic separates if following athlete loses contact)

pg.11



**Art. KAT** Kit allenamento tattico composto da 7 bande elastiche di metri 10 ciascuna

Tactical training kit made of 7 elastic bands 10 meter long each

pg.11

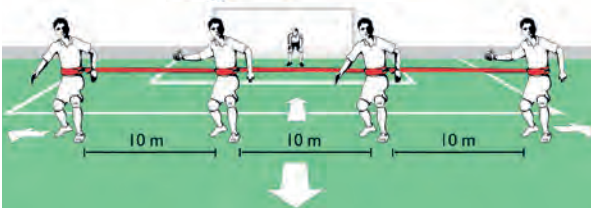
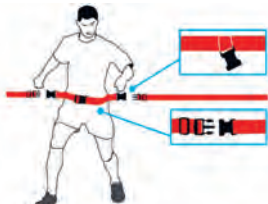

**Art. 05020798**

**Set di 4 cinture con dispositivo di fissaggio e 3 fasce non elastiche lunghe m. 10 ciascuna**

**Con questo prodotto è possibile vincolare quattro difensori allenandone il posizionamento ed i movimenti sul campo (ad esaurimento scorte)**

Set of 4 hip belts with fasteners and 3 unelastic bands 10 m. long each  
With this kit you can connect all four players of your defensive block, training their positioning and movements on the field (until available in stock)



**Art. CGG24**

**Cuscino gonfiabile con maniglie cm.70x50 per contrasto alle uscite alte del portiere**  
Inflatable cushion 70x50 cm. with handles for football goalkeeper exit training

pg.7

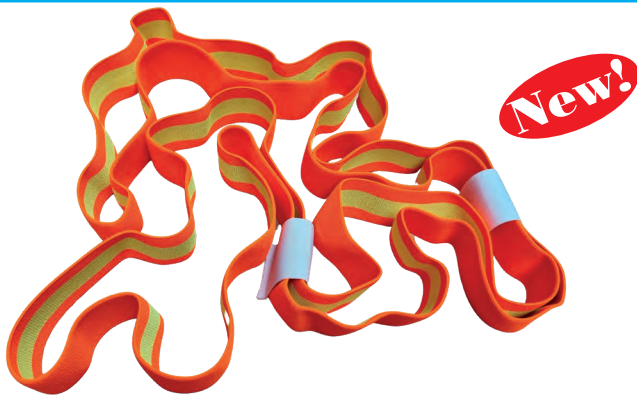

**New!**

**Art. ELAC Fascia elastica ad anello in tessuto extra strong circonferenza cm. 400 - h. cm.5 pensata per l'allenamento multidirezionale consente lo sviluppo di forza, esplosività, velocità, agilità e salto**

Elastic extra strong fabric loop band circumference 400 cm. - h. 5 cm. designed for multidirectional training allows the improvement of strength, explosiveness, speed, agility and jumping

pg.11



**Art. KAP**

**Kit allenamento portiere composto da 10 Antonelast, 1 cintura, 1 Rinforza Abduttori, 4 anelli fissa bande per il miglioramento della forza esplosiva**

Goalkeeper training kit made of 10 Antonelast, 1 belt, 1 abductor muscle band, 4 connecting rings to improve explosive muscular strength and goalkeeper's jumps and dives



**(ad esaurimento scorte)**  
**(until available in stock)**

**Art. 05021456**

**JUMP-TRAINER**

**Strumento per migliorare la potenza nel salto. Un atleta indossa la cintura regolabile con velcro, due compagni trattengono le fasce elastiche salde a terra lunghezza delle fasce elastiche m. 1,20 ciascuna (in posizione di riposo) (ad esaurimento)**

Training tool to improve jump power. One player puts on the adjustable hip belt with velcro fastener, two training partners hold the elastic bands on the ground using their feet. Length of elastic side bands (not stretched) 1,20 m. (until available)

pg.10



**Art. SC010**

**OFFERTA KIT TECNICO SCUOLA CALCIO**

pg.10

Kit così composto: n.15 paletti slalom Art.007  
n. 15 basi ad imbuto Art.018 - n. 1 kit delimitatori Art.016 - n. 6 ostacoli over cm.12 Art.80.12  
n. 2 ostacoli over cm.20 Art.80.20 - n. 2 ostacoli over cm.30 Art. 80.30 - n. 2 ostacoli over cm.40 Art.80.40  
n. 12 corde salto Art.043P - n. 1 scala a pioli Art. SL4 - n. 12 maxidelimitatori h.cm.28 Art.019.1  
n. 12 cerchi piatti diam.cm.50 Art.CNP50 - n. 1 tavoletta propriocettiva in ABS Art.168PC

**SOCCER SCHOOL KIT SPECIAL OFFER**

15 x Art.007 + 15 x Art.018 + 1 x Art.016 + 6 x Art.80.12 + 2 x Art.80.20 + 2 x Art.80.30 + 2 x Art.80.40  
+ 12 x Art.043P + 1 x Art.SL4 + 12(pieces) x Art.019.1 + 12 x Art.CNP50 + 1 x Art.168PC



Art. 80.12/80.20/80.30/80.40

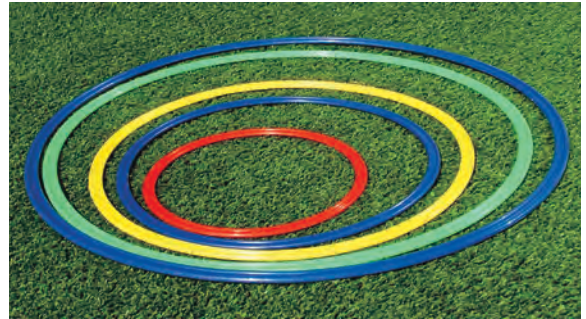

Art. CNP50



Art. 007



Art. 016



Art. SL4



Art. 019.1



Art. 168PC



Art. 018



Art. 043P

## FITNESS BODY-BUILDING

Art. S01108

Art. S01106



Art. S01106

Spalliera Svedese  
a 1 campata  
dim. cm. 90x250  
in faggio evaporato  
Swedish Wall Bar 1 span

pg.14

Art. S01108

Spalliera Svedese  
a 2 campate  
dim. cm. 180x250  
in faggio evaporato  
Swedish Wall Bar 2 spans



Art. F302

Porta dischi in ferro  
Weight Plates Rack



Art. UNG05 / UNG1 / UNG2 / UNG3 / UNG4 / UNG5 / UNG6

Coppia Manubri in ghisa rivestiti

Kg. 0,5-1-2-3-4-5-6 cadauno

Pair of Dumbbells 0,5-1-2-3-4-5-6 Kg. each one

New!

pg.12



Art. F301

Porta manubri in ferro  
Dumbbell Rack

Art. MEG6 / MEG7 / MEG8 / MEG9 / MEG10

Manubrio esagonale con rivestimento in gomma Kg. 6-7-8-9-10  
(fornito singolarmente)

Hexagonal Dumbbell with rubber coating 6-7-8-9-10 Kg.





**Art. AS196**  
Coppia  
fermadischi a vite  
Ø mm. 25  
Pair of plate  
holders with  
thread

pg.12

**Art. US176**

Coppia fermadischi a T  
Ø mm. 25  
Pair of T-shaped plate holders



**\*\*Art. US304 / US305**

Bilanciere cm. 150 / cm. 180  
Ø mm. 25  
Barbell length 150 / 180 cm.

**\*\*Art. US301** Manubrio a  
dischi inseribili  
cm. 35 Ø mm. 25  
Hand bar length 35 cm.



**\*\*Fermadischi inclusi**  
Plate holders included  
Carico massimo Kg. 100  
Maximum load 100 Kg.

**\*\*Art. US303**

Bilanciere sagomato  
cm. 120 Ø mm. 25  
Barbell length 120 cm.



**Art. UN640**  
Disco in ghisa foro mm. 25  
Kg. 0,5 - 1 - 2 - 5 - 10 - 15 - 20  
cadauno  
Cast Iron Weight Plate  
hole 25 mm.



**Art. DGG**

Disco in ghisa foro mm. 25  
rivestiti in gomma  
Kg. 0,5 - 1 - 2 - 5 - 10 - 15 - 20 cadauno  
Cast Iron Weight Plate hole 25 mm.  
covered with rubber

**Art. US287**  
Coppia fermadischi  
a molla  
Ø mm. 25  
Pair of spring  
plate holders



**Art. BO220**

Bilanciere olimpionico cm. 220  
cromato per dischi con foro da mm. 50  
carico massimo Kg.320 - fermadischi non inclusi  
Chromed olympic barbell 220 cm.  
maximum load 320 Kg. for plates with hole 50 mm. only  
(plate holders not included)

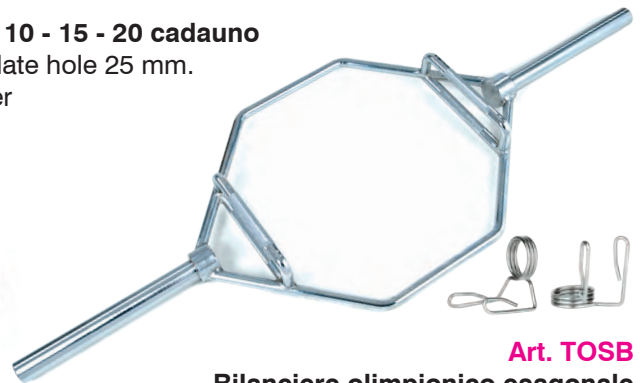

**Art. TOSB**

Bilanciere olimpionico esagonale  
cm. 145 con doppia impugnatura (shrug bar)  
per dischi con foro da mm. 50 - carico massimo Kg.300  
fermadischi a molla inclusi  
Hexagonal olympic barbell 145 cm. with double handle  
for plates with hole 50 mm. - maximum load 300 Kg.  
spring plate holders included



**Art. CFSL**

Coppia fermadischi  
per Art. BO220 - Ø mm. 50  
Pair of plate holders for Art. BO220



**New!**

**Art. AHF-155** Landmine Total Core  
Piattaforma con superficie inferiore  
antiscivolo, snodo rotante a 360° e  
doppio innesto per bilanciere  
Ø mm. 25 / mm. 50 - dotato di  
maniglia "T-Bar" per estendere  
la gamma di esercizi  
Platform with anti-skid lower surface,  
360° rotating pin and double joint for  
Ø 25 / 50 mm. barbell  
equipped with "T-Bar" handle to  
extend the range of exercises

**Art. DBCH5/ ... /DBCH25**  
Disco Bumper gommato con  
foro diametro mm. 50  
per bilanciere olimpionico  
disponibile nelle  
seguenti grammature:  
Kg.5 - 10 - 15 - 20 - 25  
Bumper Weight Plate  
hole 50 mm. covered with rubber



**Art. DGG-TRG**

Disco in ghisa gommato tri grip  
foro diametro mm. 50 per  
bilanciere olimpionico  
disponibile nelle seguenti grammature:  
Kg.1,25 - 2,5 - 5 - 10 - 15 - 20 - 25  
Tri grip cast iron Weight Plate  
hole 50 mm. covered with rubber



**Art. 13382 / 13383 / 13384 / 30937**

**Paio Cavigliere Kg. 0,5 - 1 - 1,5 - 2 cadauna**  
Pair of Ankle Weights 0,5 - 1 - 1,5 - 2 Kg. each one



**Art. AHF-093**

**Paio Cavigliere Kg. 2,5 cadauna con pesi estraibili**  
Pair of Ankle Weights 2,5 Kg. each removable weights



**Art. 17222**

**Cintura Body Building - misure da XS a XL**  
Body Building Leather Belt - sizes from XS to XL



**Art. AHF-074**  
**Coppia sostegni ruotabili per flessioni**  
Turnable Push-up handles

pg.12

pg.13



**Art. AHF-026**  
**Coppia maniglie per flessioni**  
Push-up handles



**Art. AHF-047**  
**Ruota doppia per addominali**  
Double Wheel for abdominal muscles



**Art. AHF-070**  
**Estensore con elastici**  
Chest-Expander

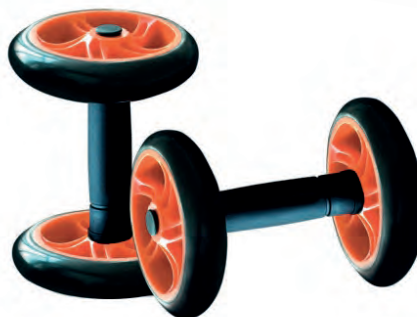

**Art. AHF-157**  
**Coppia manubri con ruote per addominali**  
Pair of dumbbells with wheels for abdominal muscles



**Art. AHF-161**  
**Coppia Parallettes h. cm. 75**  
Pair of Parallettes 75 cm. height



**Art. AHF-064**  
**Contapassi multifunzione**  
Multi-function Step Counter



**Art. 17203**  
**Paio guanti Lycra misure da XS a XL vari colori**  
Gym Gloves Lycra



**Art. 30907**  
**Paio guanti Premium Pro misure da S a XL vari colori**  
Gym Gloves Premium Pro



**Art. AHF-021**  
**Coppia Tenaglie stringimano con impugnatura soft touch**  
Pincers for hand strengthening



**Art. DEAPWR**

Ministepper a pistoni idraulici con elastici per il potenziamento di braccia, dorso e addome  
Computer a 2 funzioni: tempo, calorie  
Peso massimo utilizzatore 100 kg.  
Ministepper with hydraulic rams and elastic bands for strengthening arms, back and abdomen

pg.13

**Art. OCST**  
Gradino step a 2 altezze (cm. 10-15)  
con antiscivolo dim. cm. 68x30  
Step adjustable at 2 different heights  
(10-15 cm.) with anti-skid dim. 68x30 cm.



pg.14

**Art. WBX-70**

**Power Tower**

Attrezzo multifunzione ideato per l'allenamento intensivo di tutto il corpo senza l'utilizzo dei pesi  
Tubolare a sezione quadrata da 5 cm.  
Peso massimo utilizzatore 120 Kg.

Multi purpose tool for intensive body training without weights



**Art. AHF-003**

Gradino step regolabile a 3 altezze (cm. 15-20-25)  
con superficie antiscivolo dim. cm. 89x39  
Step adjustable at 3 different heights  
(15-20-25 cm.)  
with anti-skid surface dim. 89x39 cm.



**Art. BTM**

Barra per trazioni  
con fissaggio a parete  
Exercise Bar

pg.13



**Art. BTE**  
Barra Entroporta  
Door Bar



**Art. CGF350**  
Panca multifunzione  
telaio in acciaio,  
schienale regolabile  
portata massima kg. 100  
Weight lifting Bench



**Art. CGF450**  
Panca pesi con supporti  
bilanciere, telaio in acciaio,  
schienale regolabile  
peso max utilizzatore kg. 100  
Weight lifting Bench  
with barbell holders

ATTENZIONE: questi prodotti sono concepiti esclusivamente per uso home fitness, perciò la garanzia non copre il loro utilizzo presso palestre o centri sportivi



**Art. WBX-85**  
Panca piana/90° Power Bench  
rinforzata (abbinabile con Power Rack)  
Power Bench

pg.14



**Art. GYM1000**  
Stazione Multifunzione  
dotata di torre per dorsali, pressa per  
pettorali, attrezzo per le gambe, vogatore,  
cuscino per bicipiti - carico massimo 60 Kg.  
(pesi inclusi), 15 esercizi praticabili  
peso massimo utilizzatore 120 Kg.  
Multi purpose machine



**Art. WBX-50**  
Power Rack  
Supporti per bilanciere  
altezza e larghezza  
regolabili  
dotato di 2 rimessaggi  
per dischi  
peso massimo  
caricabile 200 Kg.  
Barbell racks

**Art. ELX-1**

Ellittica con manubrio  
e pedali regolabili  
Sistema frenante magnetico  
8 livelli di intensità con  
regolazione manuale  
Pulsazioni Hand Pulse  
Schermo LCD  
Funzioni: tempo, velocità,  
distanza, pulsazioni, calorie,  
recupero, odometro  
Peso massimo utilizzatore 120 Kg.  
Peso del volano 6 Kg.  
Elliptical exercise Bike  
7 function computer



pg.13

pg.14



**Art. WBK-100**

Panca per addominali  
massima portata Kg.110  
dimensioni cm. 126x31x31  
Abdominal bench  
maximum load 110 kg.  
dimensions 126x31x31 cm.

ATTENZIONE: questi prodotti sono concepiti esclusivamente per uso home fitness, perciò la garanzia non copre il loro utilizzo presso palestre o centri sportivi

**Art. GBX-100**

Panca ad inversione  
massima portata Kg.120  
Rotazione schienale su 3 livelli  
predefiniti (20° - 40° - 60°)  
e rotazione libera - regolabile per  
altezza utente da cm. 147 a 198  
dim. cm. 73x159x155/212  
Inversion bench  
maximum load 120 kg.  
Backrest rotation on  
3 inclinations (20° - 40° - 60°)  
and free rotation  
adjustable for user height  
from 147 cm. to 198 cm.  
dim.cm.73x159x155/212



**Art. AB-CNH**

AB Crunch Master richiudibile  
AB Crunch Master foldable



**Art. GWM13**

Pedaliera manuale utilizzabile da seduti per gli  
arti inferiori e appoggiata sul tavolo per gli arti  
superiori, peso 5 Kg. - con computer  
Intensità sforzo regolabile  
Cycling device for arm and leg exercises



**Art. GWE13**

Pedaliera elettrica per la ginnastica passiva  
degli arti inferiori e superiori, velocità regolabile  
con telecomando, peso 6 Kg. - con computer  
Cycling electric device for arm and leg exercises



**Art. BFK-300**

Bicicletta da camera con freno magnetico  
Regolazione dell'intensità manuale a 8 livelli  
Volano da 4 Kg. - Computer a 6 funzioni: tempo, velocità, distanza, calorie, scan, pulsazioni con sensori Hand Pulse  
Peso massimo utilizzatore 100 Kg. - Peso dell'attrezzo 20 Kg.  
Cyclette Magnetic with 6 function computer

**Art. BRX-60**  
Bicicletta da camera con freno magnetico  
Regolazione dell'intensità manuale a 8 livelli  
Volano da 7 Kg. - Computer a 6 funzioni: tempo, velocità, distanza, calorie, odometro, pulsazioni con sensori Hand Pulse  
Peso massimo utilizzatore 110 Kg.  
Peso dell'attrezzo 24 Kg.  
Cyclette Magnetic with 6 function computer



pg.13

**ATTENZIONE:** questi prodotti sono concepiti esclusivamente per uso home fitness, perciò la garanzia non copre il loro utilizzo presso palestre o centri sportivi



**Art. BRX-RC**

Bicicletta da camera BRX-R 65 COMFORT con freno magnetico e sedile con schienale  
Regolazione dell'intensità manuale a 8 livelli  
Volano da 7 Kg.  
Computer a 7 funzioni: tempo, velocità, distanza, calorie, pulsazioni con sensori Hand Pulse, odometro, scan  
Peso massimo utilizzatore 110 Kg.  
Peso dell'attrezzo 29,5 Kg.  
Cyclette Magnetic with 7 function computer, seat adjusting system



**Art. 18220**  
Coprisedella spinning  
Seat cover  
for spinning bike



**Art. SRX60**  
Spinning Bike  
SRX60 EVO  
con volano da 20 Kg.  
Trasmissione a cinghia con pignone fisso  
Sistema di frenaggio a tampone con feltri  
Computer con LCD (velocità, tempo, distanza, calorie, odometro, pulsazioni)  
Sella regolabile in orizzontale ed in altezza  
Manubrio regolabile in altezza con appoggio per l'avambraccio  
Portaborraccia  
Peso massimo utilizzatore 125 Kg.  
Peso dell'attrezzo 41 Kg.  
Cyclette Magnetic with seat and handle-bar adjusting systems





**Senza motore.  
Adatto per camminare,  
non per correre**  
With no engine. Suitable for  
walking, not to run

**Art. TFK-MAG**  
**TAPIS ROULANT MAGNETICO TFK-SLIM-MAG**  
piano di corsa cm.38x102  
sistema di frenaggio magnetico su 8 livelli  
doppio volano Kg.6 - peso massimo  
utilizzatore Kg.100 - display LCD indicante velocità,  
frequenza cardiaca, distanza, tempo,  
consumo calorico, scan, rilevazione cardio Hand Pulse  
Tapis roulant magnetic with no engine,  
with multi function computer

pg.14



**Art. TFK-230**  
**TAPIS ROULANT TFK-230**  
motore 1,75/2,75 HP DC - velocità 1-14 Km/h  
inclinazione manuale - piano di corsa cm. 42x121  
peso massimo utilizzatore 100 Kg.  
1 programma libero, 64 preimpostati, display LED  
indicante velocità, frequenza cardiaca, distanza,  
tempo, consumo calorico, programma in esecuzione  
Tapis roulant with 1,75/2,75 hp engine and  
multi program computer

**ATTENZIONE:** questi prodotti sono  
concepiti esclusivamente per uso  
home fitness, perciò la garanzia  
non copre il loro utilizzo presso  
palestre o centri sportivi



**Art. TFK-455**  
**TAPIS ROULANT TFK-455 SLIM - salvaspazio**  
motore 2,00/3,00 HP DC - velocità 0,8-16 Km/h  
inclinazione elettrica - piano di corsa cm.42,5x127  
peso massimo utilizzatore 110 Kg.  
1 programma libero, 12 preimpostati, display LCD  
indicante velocità, inclinazione, frequenza cardiaca  
tramite Hand Pulse, distanza, tempo,  
consumo calorico, programma in esecuzione  
Tapis roulant with 2/3 hp engine and multi program computer

**Art. TRXRC**  
**Vogatore Rower Compact - display LCD indicante  
numero vogate, calorie, tempo, scan  
regolazione sforzo su 12 livelli  
peso max utilizzatore 110 Kg.**  
Rower machine with computer

pg.14





**Art. CPGAN**

**Polsiere con gancio per esercizi alla barra per una presa più sicura e stabile grazie al gancio in acciaio rivestito in neoprene che si posiziona sotto al palmo della mano**

Wristbands with hook for bar exercises for a safer and more stable grip thanks to the neoprene-coated steel hook placed under the palm of the hand

**Art. POLTA**

**Polsiere per trazioni dotate di anello e chiusura regolabile con velcro, estremamente resistenti e adatte a polsi di qualsiasi circonferenza**

Wristbands for traction with ring and adjustable velcro closure, extremely durable and suitable for wrists of any size

pg.13



**Art. CAVTA**

**Cavigliere per trazioni dotate di anello e chiusura regolabile con velcro - comode e resistenti, si adattano a caviglie di qualsiasi circonferenza Ideali durante gli allenamenti di ginnastica, fitness e potenziamento muscolare**

Ankle straps for traction with ring and adjustable velcro closure, comfortable and durable, they fit ankles of any size - ideal for gymnastics, fitness and muscle strengthening workouts

**Art. CIPT**

**Cuscino imbottito per bilanciere per eseguire lo squat in totale sicurezza e comodità diametro cm.8, lunghezza cm.40**

Padded barbell cushion for performing squats with total safety and comfort diameter 8 cm, length 40 cm



**Art. 1FSF**

**Piastra antitrauma cm.100x100 spessore mm.10 in gomma riciclata con granulo ultrafine per proteggere il pavimento durante l'allenamento con attrezzi**

facile da posare e da pulire, antimuffa, antibatterica

Antitrauma plate 100x100 cm thickness 10 mm

in ultrafine-grain recycled rubber

to protect the floor during equipment training

easy to install and clean, mold-resistant, antibacterial



**Art. AHF-165**

**Fascia da braccio porta smartphone**  
Arm smartphone holder

**Art. E680**

**Bracciale porta oggetti in neoprene cm.14,5x8x2**  
Neoprene arm wallet



**Art. SB099**

**TUBOLARE BARRET in microfibra 108 dinari**

**Prodotto tecnico brevettato come modello d'uso CEE - Made in Italy**

**Lascia traspirare la pelle e ripara dal freddo e dal vento**

**utilissimo in molteplici situazioni:**

**durante e dopo gli allenamenti, durante gli incontri,  
per sostenere la tua squadra, nel tempo libero, in moto etc.**



**Prodotto  
bi-elastico  
senza cuciture  
bi-elastic  
seamless**

Barret TUBOLAR HAT in microfiber - made in Italy patented  
BTH lets your skin breath while protecting you from cold and wind  
you can wear it during or after training, during the game, in your spare time,  
to support your team, when riding your bike etc.

pg.16

**utilizzabile come scaldacollo, foulard, bandana, fascia, passamontagna etc.**



it can change shape from neck warmer to head band to foulard to bandana



**A differenza del comune  
prodotto in pile, la  
microfibra del Tubolare  
Barret impedisce il  
surriscaldamento e  
l'eccessiva sudorazione  
della pelle, grazie  
alla sua speciale  
traspirazione e  
leggerezza**



**PRODOTTO  
TECNICO  
TECHNICAL  
PRODUCT**

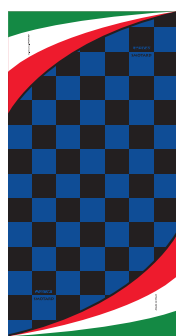
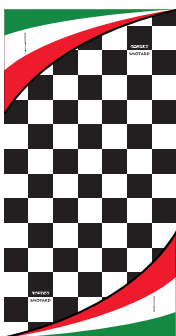

**Colori disponibili:  
bianco/nero, nero/azzurro,  
rosso/nero, bianco/celeste,  
bianco/rosso, giallo/rosso  
(prodotto personalizzabile su  
richiesta per ordine minimo di  
100 pezzi, con spese  
per elaborazione grafica da  
definire)**

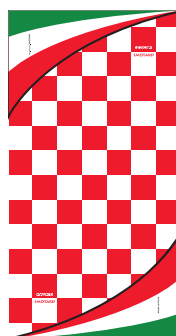
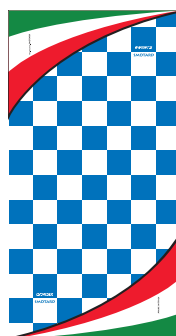
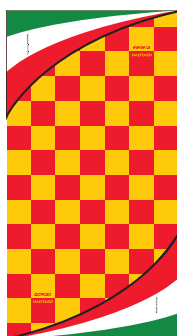

Colors available  
as in the pictures  
Barret tubolar HAT can be  
personalized with your logo and  
colors with a minimum order of  
100 pieces (graphic work not  
included in the price)

## CASACCHE - Mesh Shirts



**Art. 088-A**

### Casacca traforata fluo taglia adulto

Fluo pierced training bib adult size - colors as in the picture



**Art. 088-B**

### Casacca traforata fluo per bambini fino a 9 anni

Fluo pierced training bib small size  
(for children up to 9 years)  
colors as in the picture



pg.16

**Art. 088-D**

### Casacca traforata double-face fluo taglia adulto colori rosso/blu - giallo/arancio

Fluo pierced training bib double-face adult size  
colors red/blue - yellow/orange



**Art. GIL01**

### Gilet steward

Colori giallo, arancio  
Colors yellow, orange

## PANTALONCINI - CALZE - GUANTI Shorts - Socks - Gloves

**\*\* QUANTITÀ PER TAGLIA E COLORE MULTIPLA DI 5 PEZZI \*\***  
Quantity by size and color multiple of 5 pieces



**Art. MF01**  
Pantaloncino da allenamento  
100% poliestere  
taglie dalla 3XS alla XXL  
Colori: royal, bianco, bordeaux,  
verde, navy, rosso, nero  
(quantità per taglia e colore  
multipla di 5 pz.)  
Shorts in polyester  
size from 3XS to XXL  
Colors: white, red, royal,  
blue, black, brown, green  
(quantity by size and color  
multiple of 5 pieces)



**Offerta sul  
listino!**  
Check on  
price list!

**Art. IS005**  
Paio calze calcio con piede  
Taglie

Bimbo: 29-34  
Ragazzo: 35-40  
Uomo: 41-46

Colori: royal, giallo limone, bianco,  
bordeaux, navy, rosso, nero, verde  
Pair of soccer socks sizes: Kid, JR, SR  
Colors: white, red, royal, blue, black,  
brown, lemon yellow, green

● pg.16



**Art. E6000**  
Scaldacollo in pile  
taglia unica regolabile  
colore navy o nero  
Neck warmer in pile  
one size fits all



**Art. IGUAS**  
Paio Guanti in acrilico  
colore nero  
misura junior e senior  
con antiscivolo  
Black acrylic Gloves  
size junior and senior  
anti-skid



**Art. E6013**  
Berretto in acrilico  
nero, navy  
taglia senior  
Winter Cap  
size senior

## TACCHETTI ED ACCESSORI PER SCARPE - Studs and Shoe accessories



**Art. 265bis / 268bis / 270bis**  
**Tacchetto alluminio conico**  
mm. 14-17-19  
conf. 100 pz. per misura  
Conical aluminium Stud  
14-17-19 mm.  
100 piece pack



**Art. BACSC**  
**Blister 12 tacchetti in alluminio conici con rondelle**  
(8 x mm. 14 + 4 x mm. 17)  
12 piece pack conical aluminium studs with washers

**Art. BACS**  
**Blister 12 tacchetti in alluminio conici senza rondelle**  
(8 x mm. 14 + 4 x mm. 17)  
12 piece pack conical aluminium studs without washers

pg.14

pg.15



**Art. 262/263/264/265/266/267/268/269/270**  
**Tacchetto alluminio conico tornito**  
mm. 11-12-13-14-15-16-17-18-19  
conf. 100 pz. per misura  
Milled conical aluminium Stud  
100 piece pack



**Art. PR11 / PR13 / PR17**  
**Tacchetto alluminio conico tornito punta rinforzata** mm. 11-13-17  
conf. 100 pz. per misura  
(ad esaurimento scorte)  
Conical aluminium Stud reinforced tip 11-13-17 mm.  
100 piece pack  
(until available in stock)



**Art. A11 / A13 / A15 / A17**  
**Tacchetto alluminio conico tornito Argentinos superleggero Serie A**  
mm. 11-13-15-17  
Milled conical aluminium Stud ultra-light Serie A  
11-13-15-17 mm.



**Art. AL09F / AL11F / AL13F / AL15F**  
**Tacchetto alluminio conico tornito Argentinos superleggero Serie A con filettatura maggiorata (Adidas)** mm. 9-11-13-15  
Milled conical aluminium Stud ultra-light Serie A with increased thread (Adidas) 9-11-13-15 mm.

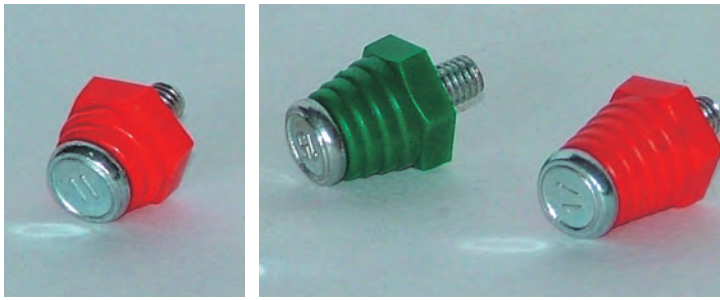

**Art. 292 / 293 / 294 / 294bis**  
**Tacchetto in nylon conico punta rinforzata in alluminio**  
 mm.11-13-15-17, conf. 100 pz. per misura (ad esaurimento)  
 Conical Nylon stud with reinforced tip - 100 piece pack  
 (until available)

pg.15



**Art. 231 / 232 / 233**  
**Tacchetto in nylon punta rinforzata**  
**in metallo mm. 11-13-16**  
**conf. 100 pz. per misura**  
 Nylon stud with reinforced tip  
 11-13-16 mm. 100 piece pack

**Art. 230**  
**Blister 12 tacchetti in nylon**  
**punta rinforzata in metallo mm. 11-13-16**  
 12 piece pack nylon studs  
 with reinforced metal tip  
 11-13-16 mm.



**Art. M204 / M205**  
**Tacchetto in nylon**  
**monocolore**  
**mm. 13 / 16**  
**conf. 100 pz. per misura**  
 Nylon Stud  
 mm. 13 / 16 - 100 piece pack



**Art. M203**  
**Blister 12 tacchetti**  
**in nylon monocolore**  
**8 x mm. 13 + 4 x mm. 16**  
**(nero, rosso, bianco)**  
 12 piece pack nylon  
 studs single color  
 (black, red, white)



**Art. 35M12**  
**Tacchetto gomma base stretta mm. 12 conf. 100 pz.**  
 Narrow Base Rubber Stud mm. 12 - 100 piece pack

**Art. 35M14**  
**Tacchetto gomma base stretta mm. 14 conf. 100 pz.**  
 Narrow Base Rubber Stud mm. 14 - 100 piece pack



**Art. 072.11.13**  
**Confezione blister 12 Tacchetti gomma**  
**base larga per terreni gelati**  
**(8 x mm. 11+ 4 x mm. 13)**  
 Wide Base Rubber Stud - for icy ground  
 12 piece pack

**Art. 302**  
**Base filettata in alluminio mm. 7, 8 (mm.10, 12 ad esaurimento)**  
 Threaded aluminium base 7, 8 mm. (10, 12 mm. until available)  
**conf. 50 pz. per misura - 50 piece pack**



**Art. 314 Rondella in alluminio - conf. 100 pz.**  
 Aluminium washer - 100 piece pack



**Art. 302G**

**Base filettata in alluminio mm. 17**  
**(mm.13 ad esaurimento) - conf. 50 pz. per misura**  
 Threaded aluminium base 17 mm.  
 (13 mm. until available) - 50 piece pack



**Art. CHAZ**  
**Chiave in acciaio zincocromata**  
 Stud Key



**Art. 317 / 318**  
**Paio tendiscarpe a molla,**  
**misura 40-42 / 43-45**  
 Shoe stretchers with spring,  
 size 40-42 / 43-45

● pg.15

● pg.16



**Art. 326 / 326FL / 327 / 327FL / 328 / 328FL**  
**Paio lacci per scarpe cm.120-150-180**  
**colori nero, bianco, giallo fluo, verde fluo, arancio fluo**  
 Pair of shoe laces 120-150-180 cm. long  
 colors: black, white, fluo yellow, fluo green, fluo orange



**Art. ALZ.SP**  
**Paio Alzatacco in gel**  
**taglia 1 donna**  
**taglia 2 uomo**  
 Gel under heel softeners  
 woman and man sizes

**Art. SOL.SP**  
**Paio solette in gel**  
**profumate ritagliabili**  
 Gel Insoles



**Art. 21654**  
**Paio solette**  
**Spugna Sport**  
 Sport Insoles

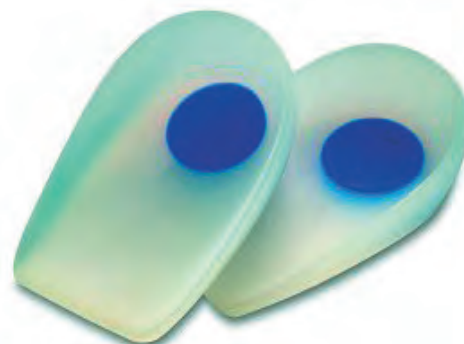

**Art. E6694**  
**Paio Alzatacco in silicone**  
**misura S (33/36) - M (37/40)**  
**L (40/44) - XL (44/48)**  
 Silicone under heel softeners  
 various sizes





**Art. 238.1**  
**Grasso Aquila Kg.1**  
 Aquila Grease for shoes  
 1 Kg.

**Art. 238**  
**Grasso Aquila ml. 100**  
 Aquila Grease for shoes  
 100 ml.

pg.15

**Art. 34071A**  
**Spray impermeabilizzante**  
 Spray waterproofing



**Art. D122X**  
**Spray Dilato ml. 200 ammorbidente**  
 Spray to soften leather  
 soccer shoes



**Art. S489**  
**Spazzola in setola naturale**  
 Shoe Brush



**Art. SL.S**  
**Spugna lucidascarpe (ad esaurimento)**  
 Shoe polisher sponge  
 (until available)



**Art. TE.540.01**  
**Zerbino pulisciscarpe in plastica con ventose**  
**dimensioni cm.35x27**  
 Shoe cleaning device  
 in plastic with suckers  
 dimension 35x27 cm.



**Art. FA270**  
**Macchina lavascarpe con 4 spazzole sostituibili**  
**getti incrociati regolabili ad alta pressione**  
**completo di poggiamani e 4 fori di fissaggio a terra**  
**in dotazione fascetta in acciaio per collegamento tubo**  
**mm. 15x21 (non incluso) alla rete idrica**  
 Shoe washing device - high pressure crossed water jets  
 iron frame with handles, replaceable brushes  
 easy fixing to the floor with 4 holes

pg.16

## PARASTINCHI - GUANTI PORTIERE - Shinguards - GK Gloves



**Art. PSCV**  
Paio parastinchi  
senza cavigliera  
misura adulto  
e bambino  
Pair of shinguards  
without ankle protection  
junior and senior size



**Art. IS30HS**  
Paio parastinchi  
senza cavigliera  
misura S-M-L  
Pair of shinguards  
without ankle  
protection  
size S-M-L

pg.16



**Art. PBC**  
Paio parastinchi  
con cavigliera  
misura adulto  
Pair of shinguards  
with ankle protection  
senior size



pg.16

**Art. F30BG**  
Paio Guanti portiere misure da 4 a 11  
Pair of Goalkeeper Gloves size from 4 to 11

I colori dei guanti raffigurati nelle immagini possono variare

## FASCE CAPITANO - Captain's Armbands



**Art. 150**  
Fascia capitano elastica  
misura adulto  
Elastic Captain's armband  
size adult

**Art. 150.B**  
Fascia capitano elastica  
misura bambino  
Elastic Captain's armband  
size children

pg.17



**Art. 150F** Fascia capitano elastica  
misura adulto colore giallo fluo  
o arancio fluo

Elastic Captain's armband adult size  
colors: fluo yellow and fluo orange



**Art. 150V / 150V.B**

Fascia capitano con velcro, taglia adulto / bambino  
Modello Champions colori bianco, rosso, giallo, verde,  
blu, fucsia, arancio - h. cm. 6,5  
Captain's armband adjustable length  
6,5 cm. height size adult / children  
colors: white, red, yellow, blue, green, fuchsia, orange



**Art. 150V.9**

Fascia capitano con velcro, taglia adulto  
colori: bianco, rosso, giallo fluo, verde,  
blu e arancio fluo - h. cm. 9  
Captain's armband adjustable length, 9 cm. height  
size adult - colors: white, red, fluo yellow,  
blue, green, fluo orange



**Art. 150V.9N**

Fascia capitano neutra con velcro, taglia adulto  
h. cm. 9 - colori: giallo fluo, arancio,  
bianco, rosso, verde, blu  
Captain's armband with no "C" printed adjustable  
length, 9 cm. height size adult - colors: fluo yellow,  
orange, white, red, green, blue



**Art.150N**

Fascia nera lutto  
Black mourning armband

## NUMERI TERMOSALDABILI Numbers for Uniforms

**Colori disponibili: bianco, giallo, rosso, verde, royal, blu, granata, nero, oro, argento**  
Available colors: white, yellow, red, green, royal, blue, brown, black, gold, silver

Art. PN23



Art. PN18



Art. PN10

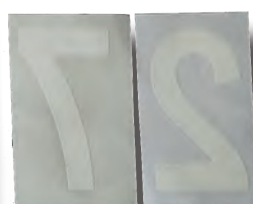

● pg.17

Art. PN23

**Numeri termosaldabili  
Omega h. 23 cm.  
numeri singoli (da 0 a 9)**  
Single numbers for sport uniforms  
Omega series 23 cm. height  
(from 0 to 9)

Art. PN18

**Numeri termosaldabili  
Omega h. 18 cm.  
numeri singoli (da 0 a 9)**  
Single numbers for sport uniforms  
Omega series 18 cm. height  
(from 0 to 9)

Art. PN10

**Numeri termosaldabili  
Omega h. 10 cm.  
numeri singoli (da 0 a 9)**  
Single numbers for sport uniforms  
Omega series 10 cm. height  
(from 0 to 9)



**TEMPERATURA  
DI APPLICAZIONE 140/145 °C  
TEMPO DI APPLICAZIONE  
15 SECONDI  
MAXIMUM TEMPERATURE 145 °C  
MAXIMUM 15 SECOND PRINT**

Art. PN4

**Numeri termosaldabili Omega h. 4 cm.  
con cerchio (da 1 a 100)  
colori bianco, blu o nero**  
Numbers for sport uniforms  
Omega series 4 cm. height with circle  
(from 1 to 100)  
black, blue or white color

## MATERASSINI - Mats

**Art. 044**  
**Materassino pieghevole**  
**alta densità**  
**cm. 180x50x0,7**  
Folding foam Mat  
high density  
180x50x0,7 cm.

**Art. 044-A**  
**Materassino pieghevole**  
**alta densità**  
**cm. 180x60x0,7**  
Folding foam Mat  
high density  
180x60x0,7 cm.



pg.17

**Art. 044-R**  
**Materassino arrotolabile**  
**alta densità**  
**cm. 180x50x0,6**  
Rolled foam Mat  
high density 180x50x0,6 cm.

**Art. AS803**  
**Materassino Exercise Mat**  
**imbottito e serigrafato cm. 180x60x2,5**  
PVC Mat 180x60x2,5 cm.



**Art. 30924**  
**Materassino Yoga arrotolabile**  
**cm. 172x60x0,4**  
Rolled Yoga Mat 172x60x0,4 cm.

## LAVAGNE TATTICHE PER CALCIO E CALCETTO - Tactical Boards for Football and Futsal

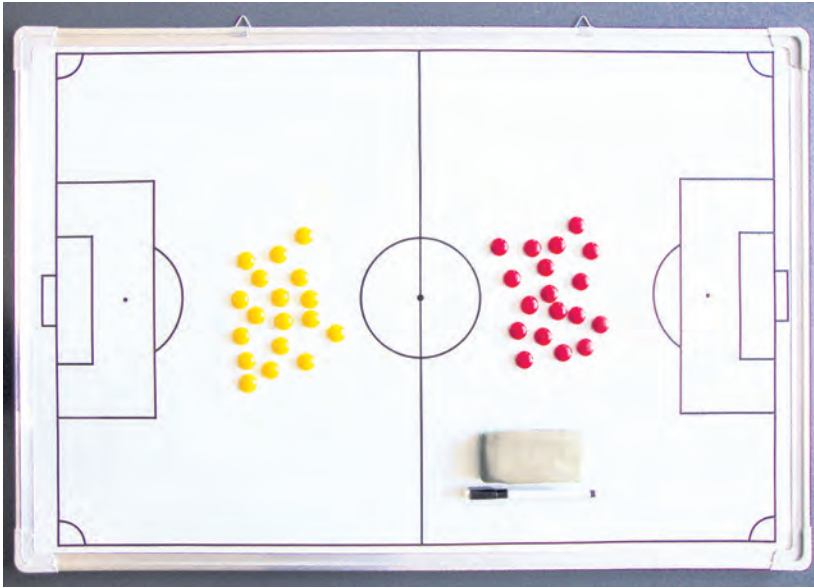

**Art. 087**

**Lavagna magnetica cm. 60x90 cancellabile con cornice metallica**

Tactical board 60x90 cm. magnetic and erasable with metal frame

**Art. 087.BO**

**Borsa per lavagna Art. 087**

Bag for tactical board Art. 087



**Art. PM60**

**Serie pedine magnetiche di ricambio per lavagna Art. 087**

Spare magnetic pieces for tactical board Art. 087

● pg.18



**Art. M087TP**

**Treppiede di sostegno in acciaio verniciato per lavagna Art. 087 (lavagna esclusa)**

Painted steel tripod for tactical board Art. 087 (board not included)



**Art. 090**

**Lavagna su treppiede con 100 fogli cm.70x100 (non cancellabili)**

Board on tripod with 100 sheets 70x100 cm. (not erasable)

**Art. 090RIC**

**Ricambio 100 fogli cm.70x100 per lavagna Art. 090 (treppiede escluso)**

100 spare sheets for board Art. 090 (tripod not included)

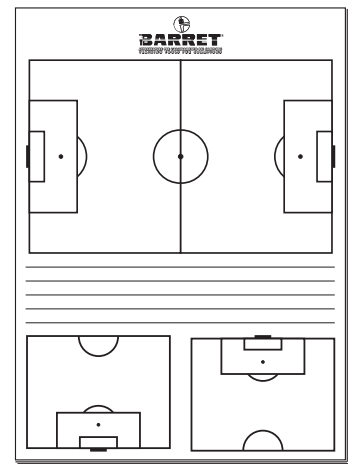

**Art. BL50F**

**Blocco con 50 fogli formato A4 (non cancellabili)**

Block with 50 A4 sheets (not erasable)



**Art. 05030425**

**Set 25 fogli adesivi cm.80x100 applicabili a porte e pareti, rimuovibili e cancellabili (ideale per partite in trasferta)**  
 Set of 25 adhesive sheets 80x100 cm. on a roll, easily separable. Due to the electrostatic charge, it can be hung on any door or wall and removed several times without leaving any trace. Ideal for away games. Either permanent or non permanent markers work for writing

● pg.18

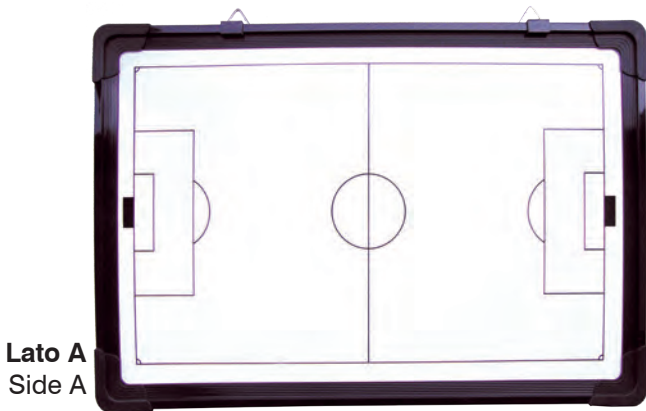

**Lato A**  
Side A



**Lato B**  
Side B

**Art. 089**

**Lavagna magnetica bifacciale cancellabile con borsa cm. 45x30**  
 2 face Tactical Board magnetic and erasable 45x30 cm. with bag

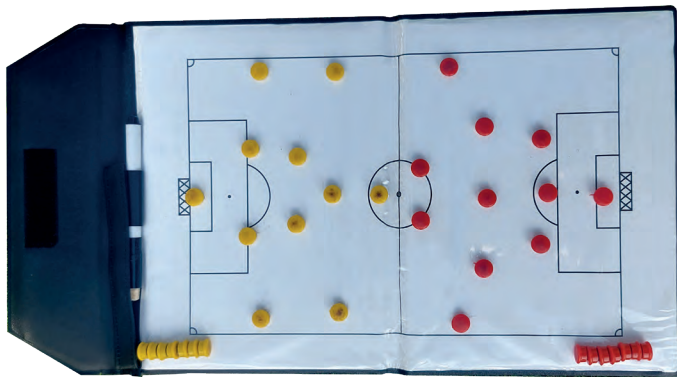

**Art. 089-P**  
**Lavagna magnetica cancellabile pieghevole cm. 46x25**  
 Foldable Tactical Board magnetic and erasable 46x25 cm.

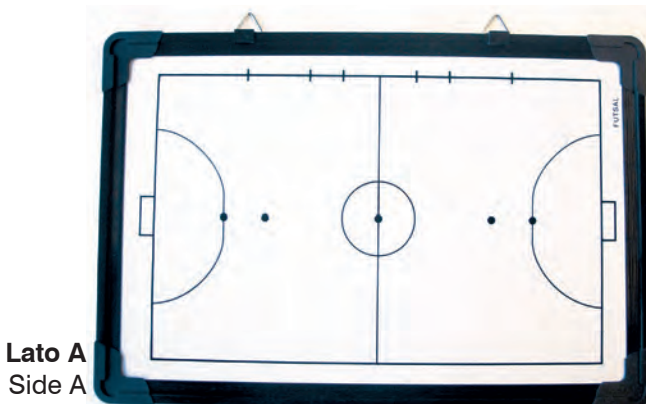

**Lato A**  
Side A



**Lato B**  
Side B

**Art. 089CM**

**Lavagna Tattica Calcio bifacciale magnetica e cancellabile cm. 45x30**  
 2 face Futsal Tactical Board magnetic and erasable 45x30 cm.

● pg.18

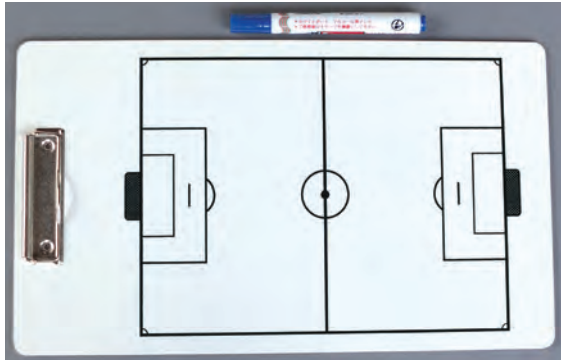

**Art. 089-A**  
**Lavagna bifacciale cancellabile cm. 40x23**  
 2 face Tactical Board erasable, 40x23 cm.



**Art. CSRK**  
**Lavagna Tattica magnetica cancellabile**  
**con block-notes cm. 40x23**  
 Magnetic Tactical Board 40x23 cm. erasable

● pg.18

● pg.18

**Art. 089-C**  
**Lavagna Tattica**  
**Calcetto bifacciale**  
**cancellabile**  
**cm. 40x23**  
 2 face Futsal  
 Tactical Board 40x23  
 cm. erasable

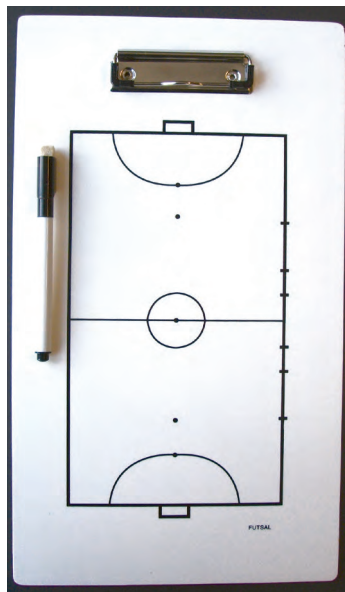

**Art. PM**  
**Serie pedine magnetiche**  
**di ricambio per lavagne**  
**di dimensioni ridotte**  
 Spare magnetic pieces  
 for small tactical boards



**Art. PAL-B**  
**Pal Block - blocco**  
**tascabile con 25 pagine**  
**copertina cancellabile**  
 Pocket block-notes  
 25 pages with erasable cover

● pg.18



**Art. 18330**  
**Lavagna magnetica cancellabile pieghevole**  
**Multisport (Calcio, Basket, Volley, Rugby,**  
**Badminton, Tennis, Floorball, Pallamano,**  
**Hockey su ghiaccio)**  
**dimensioni cm. 32x22**  
 Multisport Foldable Tactical Board magnetic and  
 erasable 32x22 cm.



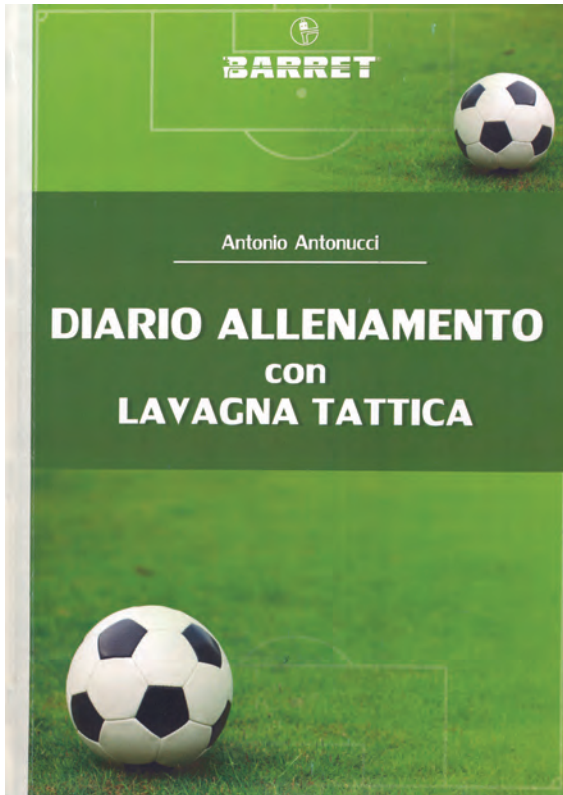

Only in Italian

**Art. DALT**  
**DIARIO ALLENAMENTO**

**per l'allenatore di calcio con lavagna tattica**

Lo strumento ideale per programmare e registrare durante il corso della stagione tutto ciò che riguarda la preparazione fisica generale, specifica e speciale, i test di valutazione, la preparazione psico-tattica teorica e pratica, la preparazione psico-cinetica, gli esercizi tecnico-tattici, il riscaldamento, il defaticamento e la preparazione post-infortunio della Vostra squadra di calcio e dei singoli giocatori che la compongono. E' inoltre fondamentale per l'annotazione di tutto ciò che riguarda le partite amichevoli e le partite di campionato, in relazione agli avversari da incontrare.

Il diario è corredato di una retrocopertina pieghevole utilizzabile come lavagna tattica cancellabile a 3 facce

140 pagine

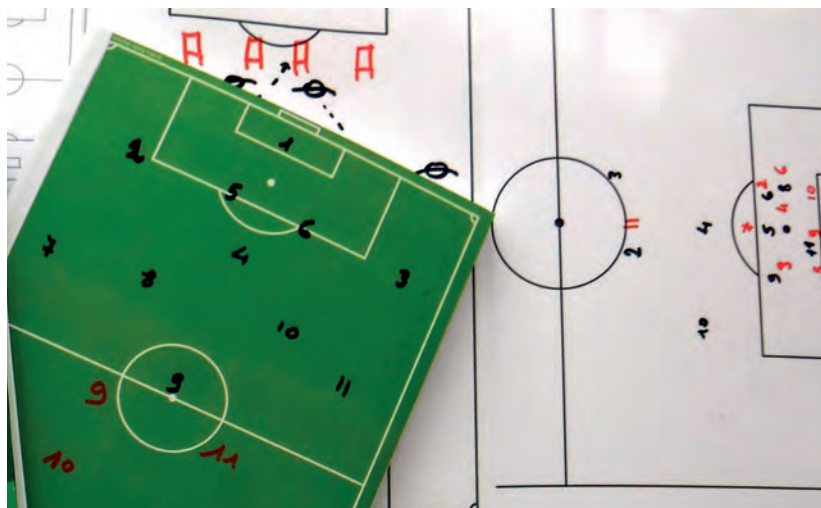

pg.18

Con lavagna cancellabile sulla retrocopertina



**GHIACCIO - TAPE - CREME - OLI**  
Ice - Tape - Creams - Oils



**Art. 164**  
Ghiaccio spray  
ml. 400  
Ice spray 400 ml.



**Art. 165**  
Ghiaccio  
in busta monouso  
Ice in envelope



**Art. NE2.5**  
Nastro economico cm. 2,5x13,7 mt  
Tape cm. 2.5x13,7 mt.

**Art. NE5**  
Nastro economico cm. 5x13,7 mt  
Tape cm. 5x13,7 mt.

**Art. N2.5**  
Nastro tipo Strappal cm. 2,5x10 mt  
Tape Strappal cm. 2,5x10 mt.

**Art. N5**  
Nastro tipo Strappal cm. 5x10 mt  
Tape Strappal cm. 5x10 mt.



**Art. 9254**  
Salvapelle  
Skin Protection

pg.17



**Art. IDNC38**  
Nastro adesivo colorato fermacalze  
cm. 3,8x9,14 mt.  
colori: rosso, nero, blu, verde e giallo  
Coloured Tape stop stockings  
in red, black, blue, green and yellow



**Art. TPG09**  
Fraplast cm. 8 (Tensoplast)

pg.18



**Art. IPT01**  
Cutter taglia bendaggi  
Cutter for bandages

**Art. IPT02**  
Forbice  
taglia taping  
in acciaio inox  
Scissors for taping



**Art. T255**  
Kinesio Tape  
Kinesio Tape



**Art. ONC**

**Olio riscaldante 500 ml  
stimola la circolazione,  
tonifica la muscolatura,  
previene le lesioni muscolari  
microtraumatiche**  
Oil 500 ml  
for muscle warm up, stimulating  
blood circulation  
and preventing micro injuries



**Art. CNC**

**Crema riscaldante 250 ml  
stimola la circolazione,  
tonifica la muscolatura,  
previene le lesioni muscolari  
microtraumatiche**  
Cream 250 ml  
for muscle warm up, stimulating  
blood circulation and preventing  
micro injuries



**Art. IRVF**

**Vaselina filante  
per curare le zone della pelle a  
maggiore sollecitazione**  
Vaseline avoiding skin problems

● pg.18



**Art. IRFA**

**Fango argilla per impacchi  
dopo distorsioni,  
per assorbimento ematomi**  
Special mud to be used after  
injuries (i.e. sprained ankles)  
and to absorb bruises



**Art. IJGE**

**Crema Gel Jesic  
coadiuvante per  
infiammazioni, contusioni  
e lesioni dell'apparato  
muscolare**  
Cream Gel Jesic  
for treating minor injuries  
and sore muscles



**Art. T10R**

**Gel  
freddo  
refrigerante  
immediato su  
contusioni o  
strappi muscolari**  
Cold Gel for  
immediate  
application on  
bruises and sore  
muscles

**Art. T17G**

**Cuscinetto  
in gel  
dim. cm.27x12  
(effetto freddo  
ed effetto caldo)**  
Gel Pillow  
27x12 cm.  
(both for cold  
and hot therapy)

**Art. T17G**

## BORRACCE - Water Bottles



**Art. K8**  
**Borraccia da 1 litro**  
**in plastica**  
1 liter plastic Water Bottle

pg.17

Certificate  
per uso  
alimentare  
Food grade  
certified



**Art. B500ML**  
**Borraccia**  
**da ½ litro**  
**in plastica**  
½ liter plastic  
Water Bottle



**Art. BAL1**  
**Borraccia da 1 litro**  
**in alluminio**  
1 liter aluminium Water Bottle



**Art. BAL05**  
**Borraccia da ½ litro**  
**in alluminio**  
½ liter aluminium Water Bottle

Certificate  
per uso  
alimentare  
Food grade  
certified



**Art. BTA05**  
**Borraccia termica**  
**da ½ litro in acciaio**  
**mantiene costante la temperatura**  
**del liquido (sia caldo che freddo)**  
½ liter thermic steel Water Bottle  
keeps the liquid temperature  
unchanged



**Art. IRTT**  
**Distributore termico 6 litri**  
**con rubinetto**  
Thermos 6 liter with tap



**Art. 308.C**  
**Cestello per 6 Borracce**  
**in plastica**  
Holder for 6 plastic  
water bottles

● pg.17



**Art. 306**  
**Kit 6 Borracce**  
**da 1 litro in plastica con cestello**  
Kit 6 one liter plastic water bottles  
with holder



**Art. C6B**  
**Cestello per 6 Borracce**  
**in plastica pieghevole**  
Foldable Holder for 6  
plastic water bottles



**Art. KIT6**  
**Kit 6 Borracce da 1 litro**  
**in plastica con cestello pieghevole**  
Kit 6 one liter plastic water bottles  
with foldable holder



**Art. OC8**  
**Cestello per 8 Borracce**  
**in plastica pieghevole**  
Foldable Holder for 8  
plastic water bottles



**Art. K8S6**  
**Kit 8 Borracce**  
**da 1 litro in plastica**  
**con cestello pieghevole**  
Kit 8 one liter plastic water bottles  
with foldable holder

## BANDIERINE - Flags



**Art. 074**  
 Kit completo  
 4 paletti  
 calcio d'angolo  
 con snodo  
 in PVC Ø mm.32  
 (bandierine colore  
 giallo o rosso)  
 Kit 4 complete  
 flexible Corner  
 Poles  
 in PVC Ø 32 mm.  
 (yellow or red flags)



**Art. 074RP**  
 Kit completo  
 4 paletti  
 calcio d'angolo  
 con snodo  
 rinforzati con tubo  
 esterno in  
 polipropilene  
 Ø mm.40  
 (bandierine colore  
 giallo o rosso)  
 Kit 4 complete  
 flexible Corner  
 Poles reinforced  
 with polypropylene  
 pipe Ø 40 mm.  
 (yellow or red flags)

pg.18



**Non utilizzabili  
 per partite ufficiali**  
 Not for official  
 matches

**Art. 073**  
 Kit completo  
 4 paletti calcio d'angolo  
 in PVC Ø mm.32  
 (bandierine colore giallo o rosso)  
 Kit 4 complete Corner Poles  
 in PVC Ø 32 mm.  
 (yellow or red flags)



**Art. 368**

**Art. 368** Kit ricambi  
 4 Bandierine calcio d'angolo  
 colore giallo o rosso  
 Kit of 4 spare Corner Flags  
 yellow or red color

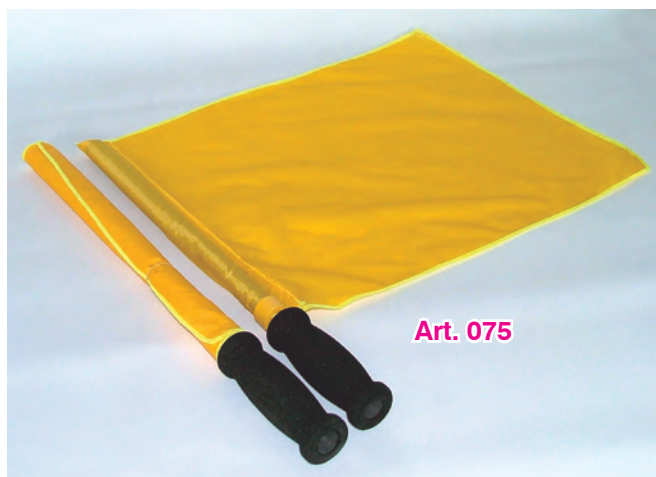

Art. 075



Art. 076

**Art. 075 / 076**

**Coppia Bandierine segnalinee gialle / a scacchi con aste in plastica**  
Pair of linesman's Flags yellow / checked with plastic sticks

pg.19

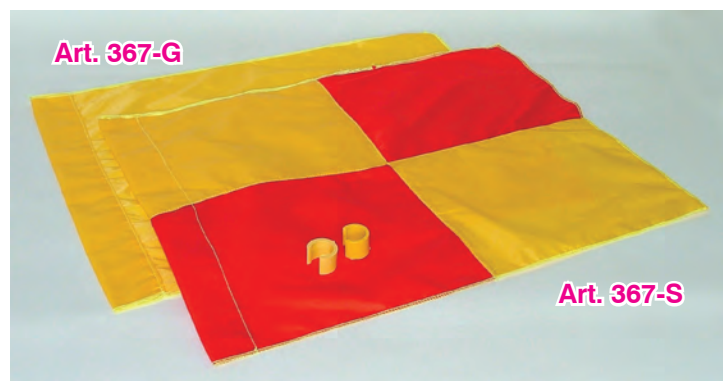

Art. 367-G

Art. 367-S

**Art. 367-G / 367-S**

**Kit ricambi 2 Bandierine segnalinee gialle / a scacchi**  
Kit of 2 spare linesman's Flags yellow / checked



**Art. 13ALC**

**Coppia Bandierine segnalinee a scacchi fluorescenti con aste in alluminio e custodia**  
Pair of linesman's Flags fluorescent with aluminium sticks and holder



pg.19

**Art. 172**

**Coppia Bandierine segnalinee elettroniche complete di ricevitore e borsa**  
Pair of electronic linesman's Flags complete with signal receiver and bag



## ACCESSORI ARBITRO - Referee's accessories



**Art. 078**  
Fischio FOX 40 Classic senza pallina  
nero o colorato  
Whistle FOX 40 Classic

**Art. 078PD**  
Fischio arbitro senza pallina  
FOX 40 Classic CMG nero o  
colorato con imboccatura  
anatomica e cordino  
Whistle FOX 40 Classic CMG  
cushioned mouth grip  
(cord is included)

pg.19



**Art. 078SK**  
Fischio FOX 40 SONIK BLAST  
CMG con cordino - vari colori,  
con due camere sonore  
Whistle FOX 40 SONIK BLAST  
CMG with cord, various colors



**Art. 078CH**  
Fischio senza pallina nero o colorato con cordino in confezione blister  
Plastic whistle various colors with cord

pg.19



**Art. 228C**  
Fischio in plastica  
nero con cordino  
Plastic black whistle  
with cord

**Art. 228**  
Fischio in plastica nero  
senza cordino  
Plastic black whistle  
without cord



**Art. 079C**  
Fischio cromato  
con cordino  
Chromed brass  
whistle with cord

pg.19



**Art. FEFOX**  
Fischio elettronico  
FOX 40 con cordino  
potenza 100 dB  
Electronic FOX 40  
whistle with cord





**Art. 080**  
Cordino Lanyard  
colore nero  
Nylon  
whistle cord Lanyard  
black color

pg.19



**Art. F40CAP**  
Cordino FOX antipanico  
regolabile, vari colori  
FOX whistle cord adjustable  
various colors



**Art. 9816**  
Laccino regolabile  
per fischietto arbitro  
Adjustable wrist lace  
for referee's whistle



**Art. KCPFOX**  
Kit cronometro da polso e  
fischietto FOX 40 Sonik Blast  
con cordino  
Kit wrist Chronometer with FOX  
40 Sonik blast whistle with cord



**Art. RPC**  
Raccoglitore ad anelli cm.18x15  
per cartellini giocatori  
con 20 buste trasparenti  
Ring binder 18x15 cm. for players'  
cards with 20 transparent envelopes



**Art. 081F** Coppia cartellini  
giallo e rosso con custodia,  
matita e tabellino gara  
Yellow and red cards with holder,  
pen and game note card

**Art. RPCRIC**  
Ricambio 10 buste trasparenti per  
raccoglitore ad anelli Art. RPC  
Set of 10 spare envelopes for Art. RPC



**Art. ZAFN**  
Tabellino gara di ricambio  
per Art. 081F  
Spare game note card for Art. 081F



**Art. GR15**  
Coppia cartellini  
giallo e rosso  
riscrivibili con pennarello  
(cancellabili con alcol)  
Rewritable yellow  
and red cards with pen  
(erasable with alcohol)

pg.19

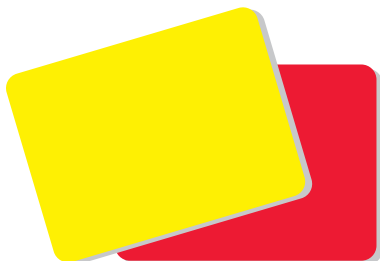

**Art. RYC02**  
Set 1 cartellino arbitro giallo  
e 1 cartellino arbitro rosso  
Set 1 yellow and 1 red card for referee



**Art. RCB**  
Cartellino arbitro blu  
Blue referee card



**Art. 880147**  
Moneta per arbitro  
in plastica  
rosso/nera  
Referee's coin

## SEGNALATORI MANUALI ED ELETTRONICI PER SOSTITUZIONI Manual and electronic Substitution Boards

**Art. 071**  
Serie numeri cambio giocatori (da 1 a 25) senza manico  
Numbers for substitution (from 1 to 25) without handle



**Art. 072**  
Serie numeri cambio giocatori (da 1 a 25) con manico  
Numbers for substitution (from 1 to 25) with handle



● pg.20

**Art. E6230**  
Segnalatore bifacciale economico per cambio giocatori manuale cm.43x38  
Substitution indicator 1 piece 2 sides

Lato A  
Side A



Lato B  
Side B



Lato B  
Side B

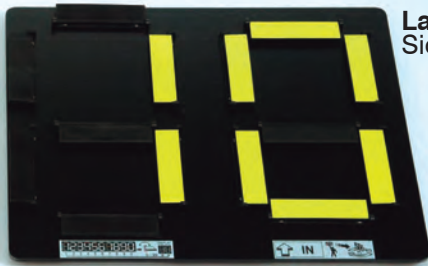
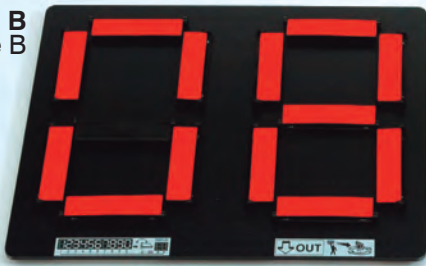

Lato A  
Side A

● pg.20

**Art. C00937**  
Segnalatore bifacciale per cambio giocatori manuale fluorescente - cm.40x32 base in plastica lucida  
Substitution indicator fluorescent 1 piece 2 sides

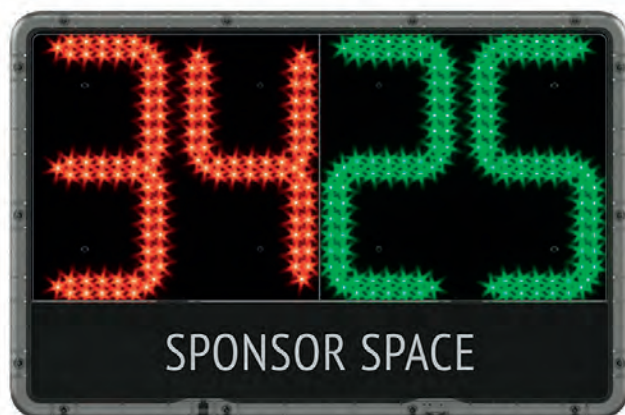

**Art. F292-30**  
Valigetta cm. 61x40x8 per Art. FINOUT4 e FINOUT8  
Case 61x40x8 cm. for Art. FINOUT4 and FINOUT8

**Art. FINOUT4**  
Tavoletta elettronica bicolore, monofacciale a 4 cifre (2+2) - led verdi per giocatore entrante led rossi per giocatore uscente, completa di caricabatteria - dim. cm. 58x38x2,7 kg. 2,2  
4 Digit Electronic Substitution Board 1 side 2 color leds (red and green) cm.58x38x2,7 Kg. 2,2 with battery charger

**Art. FINOUT8**  
Tavoletta elettronica bicolore, bifacciale a 4 cifre (2+2) - led verdi per giocatore entrante led rossi per giocatore uscente, completa di caricabatteria - dim. cm. 58x38x2,7 kg. 2,25  
4 Digit Electronic Substitution Board 2 sides 2 color leds (red and green) 58x38x2,7 Kg. 2,25 with battery charger

● pg.20

**Art. 065-EC**

**Tavoletta elettronica bifacciale, bicolore DELTA 2FE1 cm.46x33x1,8 Kg.1,5 completa di valigetta e caricabatteria**  
4 digit Electronic substitution Board  
2 sides - 2 color leds (red and green)  
bag and battery charger included

UEFA  
APPROVED



**Nuova tastiera**  
new keyboard



pg.20

**Art. D2FE**

**Tavoletta elettronica bifacciale, bicolore DELTA 2FE completa di valigetta e caricabatteria cm. 64,5x39x2,5 kg. 2,8**  
4 digit UEFA Electronic substitution Board  
2 sides - 2 color leds (red and green)  
bag and battery charger included

UEFA  
APPROVED

UEFA  
APPROVED

**Art. 065-F**  
**Tavoletta elettronica approvata UEFA/FIFA bifacciale, bicolore a 4 cifre DELTA 2F completa di valigetta e caricabatteria led rossi e verdi - cm. 64x39x3 kg. 3**  
4 digit UEFA/FIFA Electronic substitution Board 2 sides - 2 color leds (red and green)  
bag and battery charger included



## COMPRESSORE - POMPE Inflator - Pumps



**Art. 106**  
**Compressore elettrico 220 Volt con borsa**  
Electric Inflator 220 Volt with bag

pg.19

**Art. 104-A**  
**Pompa con ago**  
Pump with needle



**Art. 2005**  
**Confezione 12 Aghi con valvola per gonfiatura palloni Ø filettatura mm.5**  
Set 12 Needles with valve for inflating balls Ø 5 mm. thread

pg.19



**Art. 2005RC**  
**Ago di ricambio per compressore Art. 106 Ø filettatura mm.7,5**  
Spare needle for electric inflator Art. 106 Ø 7,5 mm. thread



**Art. PSS**  
**Pompa a staffa**  
All purpose Pump



**Art. 104-T**  
**Pompetta in gomma soft con ago e valvola di sfiato ideale per gonfiatura palloni in gomma**  
Soft Pump with needle and valve for inflating rubber balls



## MANOMETRI - CRONOMETRO - ROTELLE METRICHE - CONTAMETRI Gauges - Chronometer - Measuring Tapes - Meter Counter



**Art. 107**  
**Manometro misura pressione palloni con valvola (con indicazione pressioni consigliate per vari sport)**  
Pressure Gauge with valve (with indication of pressure for different sport balls)



**Art. CRN.E**  
**Cronometro digitale 1/100 sec.**  
Digital Chronometer 1/100 sec.



pg.19

**Art. US107**  
**Manometro misura pressione palloni alta precisione con valvola (con indicazione pressioni consigliate per vari sport)**  
High precision pressure Gauge with valve (with indication of pressure for different sport balls)



**Art. CMT** Contametri fino a m. 9999  
Meter Counter (until m. 9999)



**Art. PR30**  
**Rotella Metrica in fibra m. 30**  
Fiber measuring tape 30 m.

**Art. PR50**  
**Rotella Metrica in fibra m. 50**  
Fiber measuring tape 50 m.

**Art. PR100**  
**Rotella Metrica in fibra m. 100**  
Fiber measuring tape 100 m.

## PALLONI CALCIO - Soccer Balls



Special Price



New!



**Art. GHYB3 / GHYB4 / GHYB5**

Pallone calcio Gems Olimpico Academy da allenamento in PU BIC n. 3, n. 4 e n. 5 vari colori

Ball Gems in PU-BIK size 3, 4 and 5 various colors



**Art. GPA4 / GPA5**

Pallone calcio Gems Olimpico da allenamento in PU BIC n. 4 e n. 5 vari colori (ad esaurimento)

Ball Gems in PU-BIK size 4 and 5 various colors (until available)



**Art. GPA4OT / GPA5OT**

Pallone calcio Gems Olimpico Team da allenamento in TPU n. 4 e n. 5 (FIFA Basic) vari colori

Ball Gems in TPU size 4 and 5 various colors

pg.20



**Art. 1000MS4 / 1000MS5**

Pallone calcio da allenamento Molten misto TPU 1000MS n. 4 e n. 5 (Europa League replica) (ad esaurimento)

Molten training ball TPU size 4 and 5 (Europa League replica) (until available)



New!

**Art. F4N1000 / F5N1000**

Pallone calcio da allenamento Molten TPU F4N1000/F5N1000 n. 4 e n. 5 Molten training ball TPU size 4 and 5



New!

**Art. GRPRO**

Pallone calcio Gems Raptor Pro in microfibra da gara n. 5 FIFA Quality Pro Gems match ball microfibre size 5



**Art. F5V48TR**

Pallone calcio Molten n. 5 F5V4800 "Trofeo" per allenamento professionisti e gare ufficiali categorie inferiori Molten Soccer Ball F5V4800 "Trofeo" size 5

## PALLONI CALCETTO, DA PALLEGGIO E SPECIALI - Futsal and rubber balls



**Art. GBLD**  
Pallone calcetto Gems  
Blade in TPU Soft  
a rimbalzo controllato n. 4  
Futsal Ball Gems size 4



**Art. GBLEL**  
Pallone calcetto da gara Gems  
Blade Elite in PU Soft Hybrid  
a rimbalzo controllato n. 4  
Futsal Match Ball Gems size 4



**Art. ULT46-3**  
Pallone calcetto  
in gomma TRIAL triplo  
strato rimbalzo controllato  
gr.380 - diam. cm.19,9  
Futsal Ball slow rebound  
Trial rubber

● pg.20 ● pg.21



**Art. 26854**  
Pallone feltro indoor n. 4  
a rimbalzo normale  
Indoor Ball size 4



**Art. 45862**  
Pallone feltro indoor  
n. 4 a rimbalzo controllato  
Indoor slow rebound  
Ball size 4

**Art. ULTST3/ULTST4/  
ULTST5**  
Palloni Trial SILVER  
STREET n. 3 - 4 - 5  
doppio strato  
SILVER STREET Trial balls  
size 3-4-5 double stratum



**Art. TRILO**  
Pallone calcio Trial  
TRILO n. 4,5  
doppio strato  
limita il trauma dovuto  
all'impatto con la palla  
Soccer Ball Trial TRILO  
size 4,5 double stratum  
softens ball contact

## RETI PORTAPALLONI - Ball sacs



**Art. 041-6 / 041-12 / 041-18**  
Reti Portapalloni in polipropilene  
senza nodo (da 6, 12 o 18 palloni)  
Nets for balls in polypropylene  
(for 6, 12 or 18 balls)



**Art. S041-6 / S041-12 / S041-18**  
Reti Portapalloni in polipropilene  
con nodo (da 6, 12 o 18 palloni)  
Knotted Nets for balls  
in polypropylene  
(for 6, 12 or 18 balls)

● pg.29

**Art. SM20**  
Sacca Portapalloni  
in nylon 420/PVC  
capienza 20 palloni  
Ball Sac for 20 balls





**Art. 1935S**  
**Pallone calcio in gomma**  
**monostrato n. 3**  
**colore giallo**  
Rubber soccer Ball  
single stratum size 3  
color yellow

● pg.20



**Special Price**

**Art. V45 / V44 / V42 / V41 / V40**  
**Palloni calcio in gomma Trial monostrato n. 1 - 2 - 3 - 4 - 5**  
**(misura 5 solo nel colore bianco)**  
Rubber soccer Balls single stratum Trial size 1 - 2 - 3 - 4 - 5  
(size 5 only in white color)

● pg.21



**Special Price**

**Art. ULT42-3 / ULT41-3 / ULT40-3**  
**Palloni calcio in gomma**  
**Trial triplo strato**  
**n. 3 - 4 - 5**  
Rubber soccer Balls  
triple stratum Trial  
size 3 - 4 - 5





**Art. ULTS40**

**Pallone in gomma Trial  
allenamento potenziato doppio strato  
Ø cm.21,5 - gr.630 (+50%)  
Trial heavy rubber ball double stratum**



**Art. ULTD40**

**Pallone in gomma Trial  
allenamento potenziato doppio strato  
Ø cm.21,5 - gr.840 (+100%)  
Trial heavy rubber ball double stratum**

pg.21



**Art. TRBC**

**Pallone Reaction Ball Trial  
doppio strato rimbalzo e traiettorie  
imprevedibili per calcio  
Trial Reaction Ball double stratum  
unpredictable rebounds for soccer**



**Art. B703316**

**Reflex ball  
pallone prismatico  
in pelle sintetica  
Prismatic ball in  
synthetic leather**



**Art. E44**

**Pallone sonoro  
Torball per calcio CIP  
in gomma Trial  
Ø cm.20,5 - gr.500  
Trial rubber Torball**



pg.20

**Art. 149S14**

**Pallone in gommapiuma  
Ø cm. 14  
Foam rubber ball Ø 14 cm.**



**Art. 149S**

**Pallone in gommapiuma  
Ø cm. 20  
Foam rubber ball Ø 20 cm.**



pg.21

**Art. E48**

**Pallone sonoro Trial  
per non vedenti  
Ø cm.22 - gr.470  
Trial rattle ball for blind people**

## PALLE MEDICHE - Medicine Balls



pg.21

**Art. AHF-105 / AHF-106 / AHF-107 / AHF-108 / AHF-109 / AHF-110**

**Palle Mediche  
rigonfiabili e rimbalzanti  
kg. 1 - 2 - 3 - 4 - 5 - 6  
ad alto grip colore nero  
Medicine Balls  
inflatable and rebounding  
high grip in black color**



**Art. 048 / 050 / 051 / 052 / 053**

**Palle Mediche rigonfiabili  
e rimbalzanti Trial  
kg. 1 - 2 - 3 - 4 - 5  
(il colore varia  
a seconda del peso)  
Trial Medicine Balls  
inflatable and rebounding  
different colors for different weights**



**Art. DGMB3 / ... / DGMB10**

**Palle Mediche  
con maniglie  
kg. 3 - 4 - 6 - 8 - 10  
(kg. 2 ad esaurimento)  
Medicine Balls  
with handles**

pg.22

**Art. AHF-048/.../AHF-097**

**SLAM BALL  
kg. 2 - 3 - 4 - 5 - 6 - 7 - 8 9 -  
10 - 12 - 15**



**Art. AHF-224/.../AHF-232**

**WALL BALL  
kg. 3 - 4 - 5 - 6 - 7 - 8  
9 - 10 - 12**



pg.13

**Art. KEB4 / KEB6 / KEB8 / KEB10 / KEB12 / KEB16 / KEB20 / KEB24**

**Kettlebell in ghisa verniciata con base in gomma  
kg. 4 - 6 - 8 - 10 - 12 - 16 - 20 - 24  
Painted cast iron Kettlebells - rubber base**

**Art. RVKEB  
Rastrelliera verticale  
porta kettlebell/  
palle mediche  
(8 posti)  
8-seater vertical rack  
for cast iron  
Kettlebells/  
Medicine Balls**



pg.22

**Art. OV500 / OV1 / OV2 / OV3 / OV4 / OV5**  
**Over Ball Trial kg.0,5 - 1 - 2 - 3 - 4 - 5  
con impugnatura anatomica  
Over Ball Trial**



**Special  
Price**



pg.22

**Art. WMD100 / WMD200  
WMD300 / WMD400 / WMD500**  
**Palle Mediche morbide Bubble  
Trial - kg. 1 - 2 - 3 - 4 - 5  
Soft Trial Medicine Bubble Balls  
kg. 1 - 2 - 3 - 4 - 5**





**Art. FLUIB05 / FLUIB1 / FLUIB2 / FLUIB3 / FLUIB4 / FLUIB5**

**Palle mediche FLUIBALL riempite con acqua demineralizzata colorata - peso kg. 0,5-1-2-3-4-5**

pg.22

FLUIBALL Medicine balls filled with demineralized coloured water - weight 0,5-1-2-3-4-5 Kg.

Grazie a queste nuove palle mediche gli atleti utilizzano carichi non inerti ma dinamici, effettuando esercizi di forza coordinata nuovi e destabilizzanti. La massa oscillante all'interno della palla medica FLUIBALL impone, sia in fase di lancio che di carico, adattamenti muscolari e coordinativi istantanei la cui intensità è variabile, e quindi non prevedibile. Inoltre, per i più giovani le palle mediche FLUIBALL sono molto efficaci per la memorizzazione della tecnica e per migliorare la conoscenza ed il controllo del proprio corpo. È possibile gonfiare e sgonfiare tutte le FLUIBALL variandone così la sofficietà

The new FLUIBALL medicine balls allow new exercises for muscle strength, equilibrium and coordination.

The liquid inside these balls makes them dynamic weights that require new rapid and adapting movements both when throwing and when lifting. Younger players will also improve and memorize body movements enhancing their equilibrium. These balls can be inflated or deflated so that softness will change

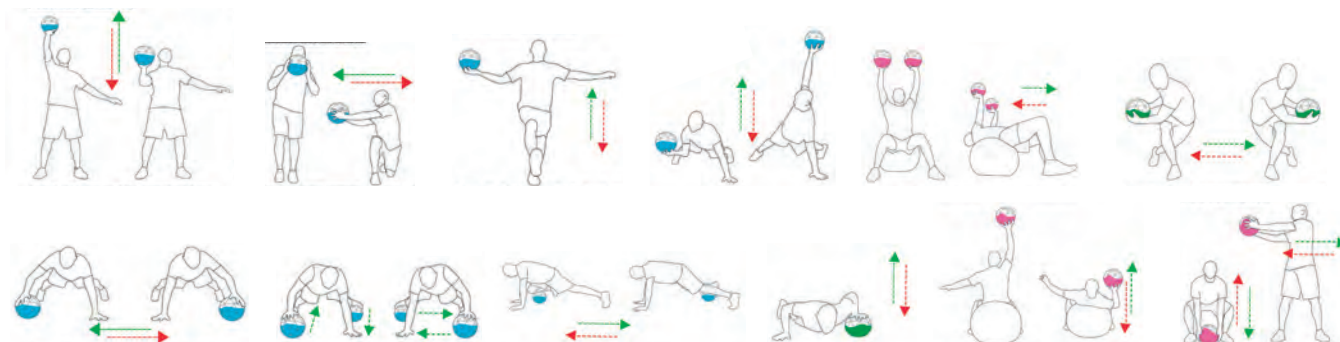

**Con le palle mediche FLUIBALL è possibile effettuare un allenamento dinamico utile per il rafforzamento degli arti inferiori e superiori, e per migliorare l'abilità nel lancio e nella presa**

With FLUIBALL you can run a dynamic training good for strengthening the lower and upper limbs, and to increase the ability of making throws and holds

**Art. POL1 / POL1.5 / POL2 / POL3 / POL3.5**

**POLIBOLO - Over Ball Trial a massa oscillante (riempite con acqua distillata) peso kg.1 - 1,5 - 2 - 3 - 3,5**

POLIBOLO - Over Ball Trial filled with distilled water - weights 1 - 1,5 - 2 - 3 - 3,5 Kg.

pg.22



**Le Over Ball e le Polibolo possono essere utilizzate sia come manubri sia come palle mediche**

Over Balls and Polibolos can be used both as dumbbells and medicine balls

## PALLE RITMICHE, PSICOMOTORIE E LUDICHE - Rhythmic and Gym Balls



pg.21

**Art. GS42/GS41/GS40/GS39** Palle Ritmiche Trial - Trial Rhythmic Balls gr. 400-350-250-150



**Ideali per trattamento  
fisioterapico,  
equilibrio, stretching,  
tonificazione, attività  
aerobica, scarico  
vertebrale,  
riscaldamento,  
potenziamento  
muscolare ...**

Very useful for injury  
recovery, equilibrium,  
stretching, muscle  
training, aerobic activity,  
warm up ...



**Art. 30934/30935/30936/31036**

### Palle psicomotorie monostrato

Gym balls single stratum

Ø cm. 55

Ø cm. 65

Ø cm. 75

Ø cm. 85

**Art. V10/V11/V12/V13/V14/V15/  
V16/V17/V18/V19**

### Palle psicomotorie Trial in gomma doppio strato (il colore varia a seconda del diametro)

Trial Gym balls  
in double stratum rubber

Ø cm.14-18-22-30

42-53-65-90-120-150



pg.23

**Art. V-LAB**

### Palla psicomotoria Trial La Ball con range di possibile utilizzo da cm.50 a cm.70 struttura instabile in gomma doppio strato particolarmente elastica

Gym ball Trial La Ball  
inflatable from 50 to 70 cm.

changing shape

concept in very elastic

double stratum rubber



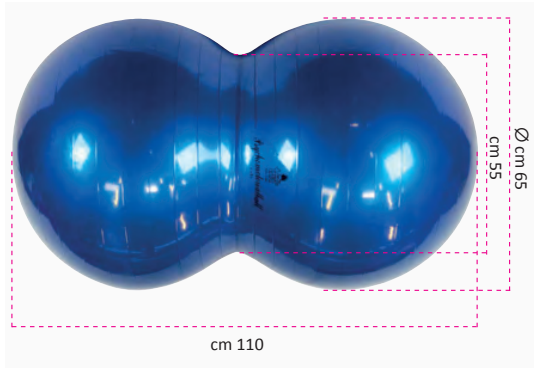

**Art. TERV16**  
X-Ball Trial ø cm.65  
X-Ball Trial ø 65 cm.

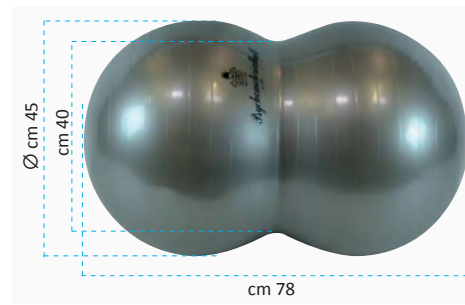

pg.23

**Art. TERV14**  
X-Ball Trial ø cm.45  
X-Ball Trial ø 45 cm.



**Art. TERV12**  
Small Peanut Trial ø cm.35  
Small Peanut Trial ø 35 cm.

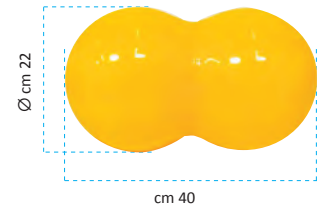

**Art. TERV10**  
Small Peanut XS  
Trial ø cm.22  
Small Peanut XS  
Trial ø 22 cm.

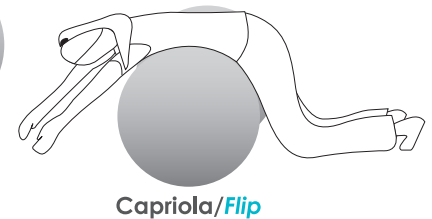
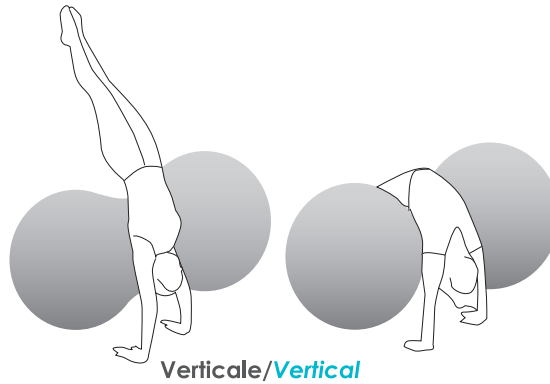

Attrezzi polivalenti in gomma sintetica in doppio strato reticolato che consentono nuovi esercizi ideati per il consolidamento degli schemi motori, alla rieducazione e riabilitazione, alla ginnastica dolce. Nella riabilitazione sono uno strumento che dà sicurezza offrendo migliore stabilità agli esercizi. X-Ball in particolare, con il restringimento centrale che la rende in parte concava, può essere utilizzata anche per insegnare la capriola e la verticale in totale sicurezza.

Infatti, in ambito educativo, consente di effettuare esercizi a due bambini (lavoro di gruppo e socializzazione) o ad uno solo (cavalcioni) in assoluta sicurezza fisica e psicologica. Indispensabile anche nel trattamento fisioterapico per riscaldamento, stretching, tonificazione. Rigonfiabile e resistente a carichi anche elevati.

Small Peanut e Small Peanut XS sono dedicate ai più piccoli in virtù dell'altezza minima dal terreno.

Abbandonarsi sulla palla, aiutando il movimento con il rotolamento e l'allungamento, permette ai bambini di sperimentare nuove sensazioni che portano ad una maggiore consapevolezza del corpo e delle sue capacità. Il diametro è studiato per accompagnare i movimenti, e accogliere il corpo perfettamente rilassato soprattutto nell'appoggio di braccia e gambe.

**La qualità, la morbidezza e l'elasticità le rendono assolutamente sicure**

Multi-purpose tools in double layer synthetic rubber that allow new exercises suitable for consolidation of motor patterns, to re-education and rehabilitation, to gymnastics. In rehabilitation they give security by offering better exercise stability. X-Ball in particular, with the central narrowing that makes it partly concave, can also be used for teaching the somersault and the handstand in total safety.

In fact, in the educational field, it allows exercises for two children (group work and socialization) or to one (astride) in absolute physical and psychological safety. Really useful also in physiotherapy treatment for warming up, stretching, toning. Re-inflatable and resistant to even high loads.

Small Peanut and Small Peanut XS are dedicated to children due to the minimum height from the ground.

Indulging on the ball, helping the movement with rolling and stretching, allows them to experience new sensations that lead to a greater awareness of their body and its capabilities. The diameter is designed to accompany their movements, and accommodate the relaxed body especially in resting the arms and legs.

Quality, softness and elasticity make them absolutely safe

**Art. ULTbbs3**  
**Pallone Jumbo Trial a 3 strati**  
 Ø cm.28 - gr.280  
 Jumbo Trial Ball triple stratum  
 Ø 28 cm. - 280 gr.



**Rimbalzo normale con diametro maggiorato per favorire l'apprendimento del bambino**  
 Normal rebound with bigger diameter for youngest training and fun

pg.21

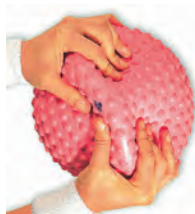

**Le palle sensoriali rimbalzanti esaltano la tattilità e rappresentano anche uno strumento di automassaggio a pressione**  
 To stimulate touch and also useful massage tools



**Art. BTR1**  
**Palla sensoriale Ø cm. 21 - gr. 420**  
 Sensory Ball Ø 21 cm. - 420 gr.

**Art. BTR2**  
**Palla sensoriale Ø cm.12 - gr. 180**  
 Sensory Ball Ø 12 cm. - 180 gr.

**Allenando la visibilità laterale migliorano la percezione dello spazio, i movimenti e la sicurezza nella vita quotidiana**  
 For space perception, coordination and everyday life safety



**Art. TLV16**  
**Palle morbide Trial per allenamento della visibilità laterale - set di 6 palle**  
 Ø cm. 16 gr. 110  
 Soft balls for lateral visibility training - set of 6 balls  
 Ø 16 cm. 110 gr.

**Art. TLV21**  
**Set di 6 palle**  
 Ø cm. 21 gr. 160  
 Soft balls for lateral visibility training - set of 6 balls  
 Ø 21 cm. 160 gr.

pg.8



**Art. BS1T**  
**PALLONE BASIC jelly touch**  
 Ø 12/16 cm. gr.140 - colore verde  
 Basic Ball green color

**Art. BS2T**  
**PALLONE BASIC jelly touch**  
 Ø 16/22 cm. gr.180 - colore arancio  
 Basic Ball orange color

**Art. BS3T**  
**PALLONE BASIC jelly touch**  
 Ø 22/28 cm. gr.240 - colore rosso  
 Basic Ball red color

pg.21

## CONTENITORI PORTAPALLONI - Baskets for balls



**Art. FP400**  
**Contenitore portapalloni a soffietto in alluminio**  
cm. 60x60x100h pieghevole con sacca  
Basket for balls in aluminium  
60x60x100h cm. foldable with bag



**Art. F401**  
**Contenitore portapalloni in ferro verniciato**  
cm. 80x55x60h pieghevole  
Basket for balls in painted steel 80x55x60h cm. foldable



pg.23

**Art. F402**  
**Contenitore portapalloni**  
in ferro zincato  
cm. 60x60x90h pieghevole  
Basket for balls  
in galvanized steel  
60x60x90h cm. foldable

**Art. F404**  
**Contenitore portapalloni**  
in rete metallica verniciata  
cm. 70x70x70h pieghevole  
con lucchetto  
Basket for balls  
painted with metallic net  
70x70x70h cm.  
foldable, with lock



**Art. F403G** **Contenitore portapalloni**  
in ferro verniciato cm. 100x75x90h  
pieghevole con lucchetto  
Basket for balls in painted steel  
100x75x90h cm. foldable, with lock



pg.23

**Art. F403ZN**  
**Contenitore portapalloni**  
in ferro zincato cm. 100x75x90h  
pieghevole con lucchetto  
Basket for balls in galvanized steel  
100x75x90h cm. foldable, with lock



## BORSE - Bags

### Art. STD02

**Borsa Big  
doppio fondo  
cm. 53,5x45h.x32,5  
poliestere 600  
Soccer bag large**



### Art. STD09

**Borsa Medium  
doppio fondo  
cm. 50x42h.x30  
poliestere 600  
Soccer bag medium**

### Art. STD03

**Borsa Small  
doppio fondo  
cm. 47,5x40h.x26,5  
poliestere 600  
Soccer bag small**

#### QUANTITÀ PER MODELLO E COLORE MULTIPLA DI 10 PEZZI

Quantity by model and color  
multiple of 10 pieces

**COLORI DISPONIBILI  
rosso, royal, navy (no Small),  
nero, verde, bordeaux**  
Colors: red, royal, black,  
green, navy (no Small),  
bordeaux



pg.23

#### QUANTITÀ PER COLORE MULTIPLA DI 15 PEZZI

Quantity by color  
multiple of 15 pieces



#### QUANTITÀ PER COLORE MULTIPLA DI 10 PEZZI

Quantity by color  
multiple of 10 pieces

### Art. STD04

**Borsa TOP bicolore in poliestere 600 con fondo  
rigido h. 15 cm. con tracolla e porta nome,  
tre tasche, dim. cm. 53,5x45h.x32,5  
colori: navy/royal, nero/grigio, navy/rosso,  
nero/verde, navy/giallo, nero/rosso, nero/bordeaux**  
Soccer Bag bicolor in polyester 600 1 pocket  
size 53,5x45h.x32,5 cm.  
colors: navy/royal, black/grey, navy/red, black/green,  
navy/yellow, black/red, black/bordeaux



### Art. STD18

**Zainetto doppio fondo poliestere 600  
2 tasche - cm. 34x47h.x24 fondo rigido**  
colori: royal, nero, rosso,  
navy, verde, bordeaux  
Rucksack in 6 different colors





**Art. STD20**  
**Borsa Portamute cm. 65x34h.x27**  
**poliestere 600 - colore nero**  
Soccer bag for uniforms  
dim. 65x34h.x27 cm. - color black

**QUANTITÀ PER COLORE**  
**MULTIPLA DI 10 PEZZI**  
Quantity by color  
multiple of 10 pieces



**Art. STD08**  
**Borsa palestra poliestere 600 cm.60x30h.x32**  
**con due tasche e vano portascarpe**  
**colori rosso, royal, navy, nero**  
Gym Bag color black, red, royal, navy

pg.24



**Art. ZBGL**  
**BORSA/ZAINETTO monocolor economica**  
**cm. 36x38 vari colori - serigrafabile su richiesta**  
Backpack one color with your logo on request



**Art. STD07**  
**Borsa Medica dim. cm. 40x28,5h.x20**  
**poliestere 600 - colore nero**  
Bag for First Aid 40x28,5h.x20 cm.



**Art. BMD**  
**Borsa Medica dim. cm. 37x29h.x17**  
Bag for First Aid 37x29h.x17 cm.

## PORTE CALCIO - Soccer Goals



**Art. SPP45**  
Set 4 protezioni imbottite  
h, cm. 200  
per paletti posteriori  
tendirete  
Set of 4 soft protections  
200 cm. height  
for net holder posts

Da abbinare preferibilmente a reti con  
profondità cm. 170x170 oppure cm.200x200  
To be combined preferably with nets with  
depth 170x170 cm. or 200x200 cm.

**Art. SPR45**  
Set protezioni imbottite  
per coppia ribaltine alzarete  
Set of soft protections  
for pair of ground backframes

**Art. GPRVE**  
Kit guaina di rivestimento  
in PVC verde per protezioni Art. SPR45  
Kit external coating in green PVC for soft  
protections Art. SPR45

### Art. 109

**Coppia Porte fisse regolamentari in lega leggera costruite secondo lo standard europeo di qualità UNI EN 748 con paletti tendirete posteriori in acciaio zincato, pali sezione mm. 120x100 verniciati con smalto acrilico non tossico, ganci reggirete e bussole per interrimento pali incluse (ribaltine alzarete non incluse)**  
Pair of regular Goals in light alloy manufactured according to the UNI EN 748 European standard of quality norms. Pipe section 120x100 mm. painted with non toxic white. Net holders, rear posts and underground sockets included (liftable ground backframes not included)

pg.24

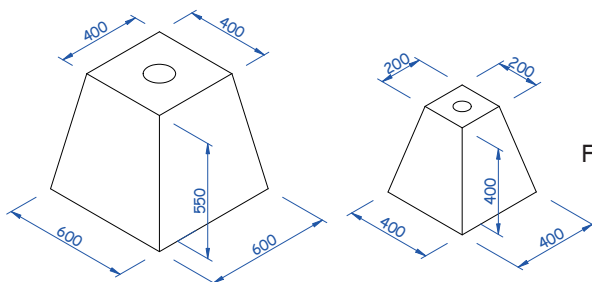

**Ancoraggio tramite  
plinti in cemento  
(non inclusi)**  
Fixing with concrete blocks  
(not included)

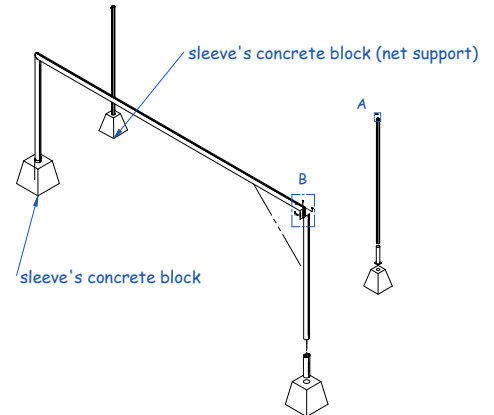

**ATTENZIONE: in caso di ordine errato da parte del Cliente le porte, una volta consegnate, non possono essere rese**

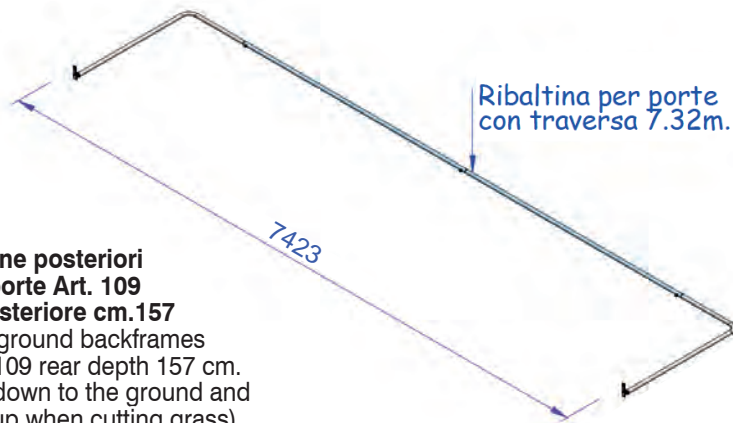

**Art. 109.G**  
Coppia ribaltine posteriori  
alzarete per porte Art. 109  
profondità posteriore cm.157  
Pair of liftable ground backframes  
for Goals Art. 109 rear depth 157 cm.  
(to keep nets down to the ground and  
to raise them up when cutting grass)

**Art. 109.G200**  
Coppia ribaltine posteriori alzarete per porte Art. 109  
profondità posteriore cm.200  
Pair of liftable ground backframes for Goals Art. 109 rear depth 200 cm.  
(to keep nets down to the ground and to raise them up when cutting grass)

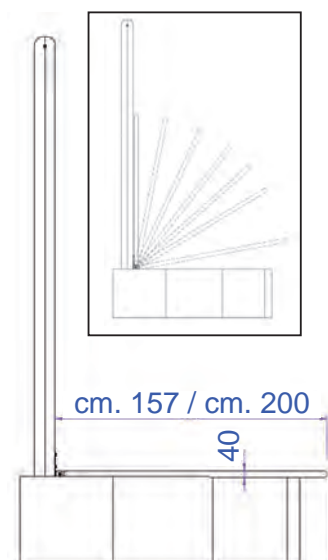

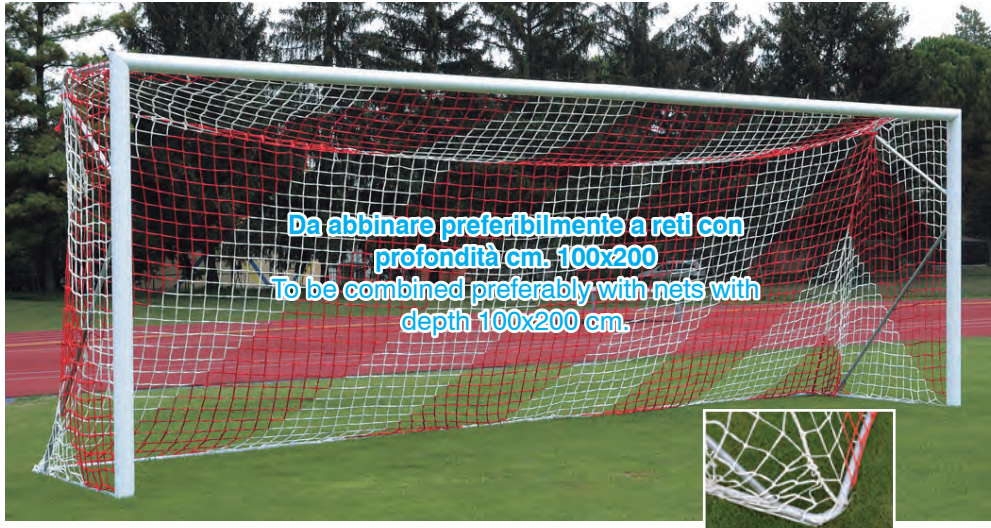

**Art. 120-RG** pg.25  
**Coppia ruote per porte trasportabili regolamentari**  
 Art. 110FG, 110-D e 110G  
 Pair of wheels for regular size transportable goals  
 Art. 110FG, 110-D and 110G

**Art. 110FG** Coppia Porte Trasportabili in lega leggera dimensioni regolamentari profilo sezione mm. 120x100 verniciate con smalto acrilico non tossico base di appoggio posteriore con tubo tondo in ferro - a norma UNI EN 748  
 Pair of transportable Goals in light alloy regular size, pipe section mm. 120x100 painted with non toxic white - back frame in round iron pipe - UNI EN 748 standard



**LE PORTE TRASPORTABILI IN FASE DI GIOCO DEVONO ESSERE ZAVORRATE SULLA BASE POSTERIORE O FISSATE A TERRA CON PICCHETTI PER MOTIVI DI SICUREZZA. LE RUOTE GOMMATE SONO OPTIONAL**

Transportable goals must always be anchored to the ground by sacs of sand or metal pegs, for safety reasons. Wheels are optional

**Art. 110-D**  
**Coppia Porte Trasportabili dim. regolamentari in lega leggera profilo sezione mm. 120x100 - verniciate con smalto acrilico non tossico base di appoggio posteriore con profilo ovale in alluminio mm. 65x55 - a norma UNI EN 748**  
 Pair of transportable Goals in light alloy regular size, pipe mm. 120x100 painted with non toxic white - back frame in aluminium ovoidal pipe 65x55 mm.

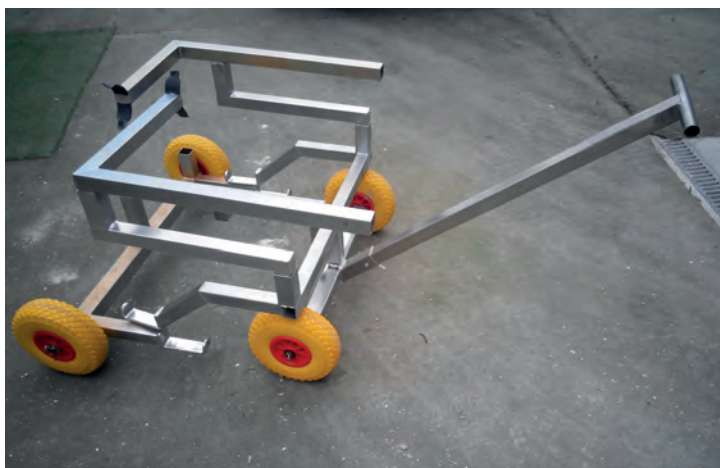

**Art. AMCP** pg.26  
**Carrello per il trasporto di porte (trasportabili) regolamentari e ridotte - brevettato**  
 Patented trolley for moving official and junior size transportable goals



**Art. 110G Coppia Porte Trasportabili in lega leggera dimensioni regolamentari profilo mm. 120x100 verniciate con smalto acrilico non tossico, base di appoggio posteriore con profilo in lega mm. 120x100 - a norma UNI EN 748 e FIGC**  
 Pair of transportable Goals in light alloy regular size, pipe mm. 120x100, painted with non toxic white - back frame pipe 120x100 mm. - UNI EN 748 and FIGC standard



**Art. 110GMR Set 4 ruote per porte trasportabili regolamentari Art. 110G (2 set per 1 coppia di porte). Ciascuna ruota in dotazione ha una posizione di riposo e una posizione di trasporto (per passare dall'una all'altra occorre far ruotare il dispositivo intorno al perno). Dunque, le ruote restano sempre fissate al telaio posteriore della porta**

Set of 4 wheels for regular size transportable goals Art. 110G (2 set for 1 pair of goals). Each wheel remains fixed to the back ground frame also when goals are in use, in stand by position. To switch the wheel into transport position you have to turn it around the pivot

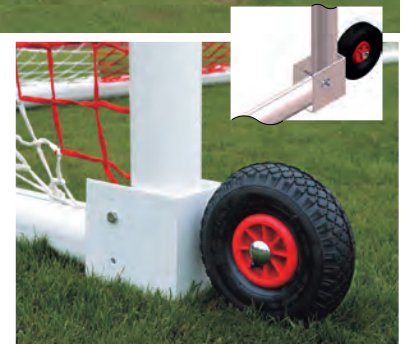

**Art. 120-RG Coppia ruote per porte trasportabili regolamentari Art. 110FG, 110-D e 110G**  
 Pair of wheels for regular size transportable goals Art. 110FG, 110-D and 110G

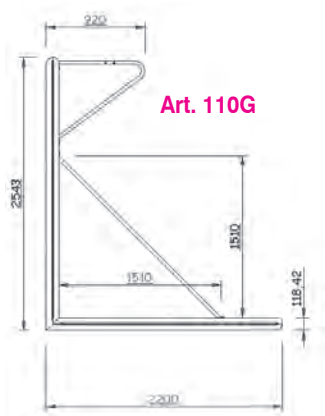

**Art. 110G**

**Art. 4580M Mollone per ancoraggio porte trasportabili regolamentari e ridotte su terreno naturale**  
 Spring for goal anchoring on natural grass

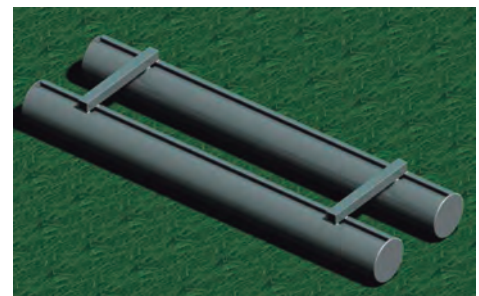

**Art. AFC Zavorra in alluminio per ancoraggio porte trasportabili regolamentari e ridotte**  
 Aluminium weighted pipes for goal anchoring

**ATTENZIONE: in caso di ordine errato da parte del Cliente le porte, una volta consegnate, non possono essere rese**

**Art. DSSCE Sacco zavorra vuoto (da riempire con sabbia) per ancoraggio porte trasportabili regolamentari e ridotte**  
 Empty Ballast Bag (to be filled with sand) for goal anchoring

pg.26



**Art. DSS20 Sacco zavorra kg. 20 (riempito con sabbia) per ancoraggio porte trasportabili regolamentari e ridotte**  
 Ballast Bag weight 20 Kg. for goal anchoring

**Porte fisse (con bussole e pali da interrare) e trasportabili in lega leggera o acciaio, sezione tubo mm. 120x100 o mm.80 - dimensioni m. 3x2 - m. 4x2 - m. 5x2 - m. 6x2**  
 Fixed and transportable Goals in light alloy or painted steel, pipe section 120x100 mm. or 80 mm. dimensions m. 3 x 2 - m. 4 x 2 - m. 5 x 2 - m. 6 x 2

pg.25

pg.26

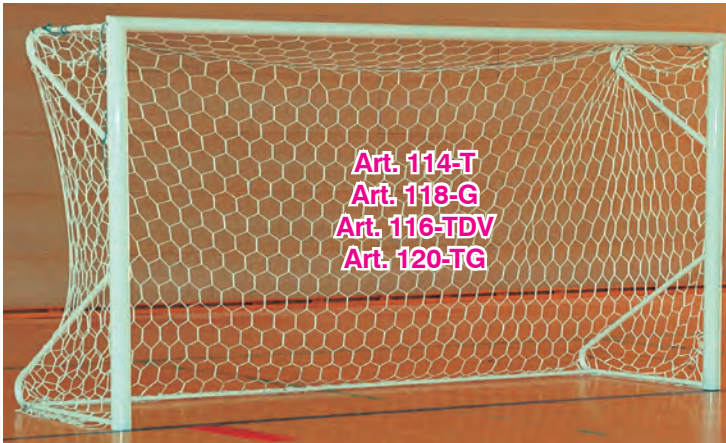

Art. 114-T  
 Art. 118-G  
 Art. 116-TDV  
 Art. 120-TG

**Base posteriore in tubo tondo**  
 Round pipe ground base

**ATTENZIONE: in caso di ordine errato da parte del Cliente le porte, una volta consegnate, non possono essere rese**

**Art. 114-T**

**Coppia Porte m. 4 x 2 a traversa intera in acciaio trasportabili tubo sezione 80 mm.**  
 Pair of Goals m. 4 x 2 - 1 piece crossbar in painted steel, transportable, pipe 80 mm.

**Art. 118-G**

**Coppia Porte m. 4 x 2 a traversa intera in lega di alluminio trasportabili tubo sezione 80 mm.**  
 Pair of Goals m. 4 x 2 - 1 piece crossbar in light alloy, transportable, pipe 80 mm.

**Art. 116-TDV**

**Coppia Porte m. 5 x 2 a traversa divisa in lega di alluminio trasportabili tubo 80 mm.**  
 Pair of Goals m. 5 x 2 - crossbar in 2 pieces in light alloy, transportable, pipe 80 mm.

**Art. 120-TG**

**Coppia Porte m. 6 x 2 a traversa divisa in lega di alluminio trasportabili tubo sezione 80 mm.**  
 Pair of Goals m. 6 x 2 - crossbars in 2 pieces in light alloy, transportable, pipe 80 mm.

**Art. 118A**  
**Coppia Porte m. 4 x 2 a traversa divisa in lega di alluminio trasportabili tubo 80 mm. con base posteriore a sezione quadra**  
 Pair of Goals m. 4 x 2 - crossbars in 2 pieces in light alloy, transportable, pipe 80 mm. with square pipe ground bases

**Art. 1129A**  
**Coppia Porte m. 5 x 2 a traversa divisa in lega di alluminio trasportabili tubo 80 mm. con base posteriore a sezione quadra**  
 Pair of Goals m. 5 x 2 - crossbars in 2 pieces in light alloy, transportable, pipe 80 mm. with square pipe ground bases

**Art. 1121A**  
**Coppia Porte m. 6 x 2 a traversa divisa in lega di alluminio trasportabili tubo 80 mm. con base posteriore a sezione quadra**  
 Pair of Goals m. 6 x 2 - crossbars in 2 pieces in light alloy, transportable, pipe 80 mm. with square pipe ground bases

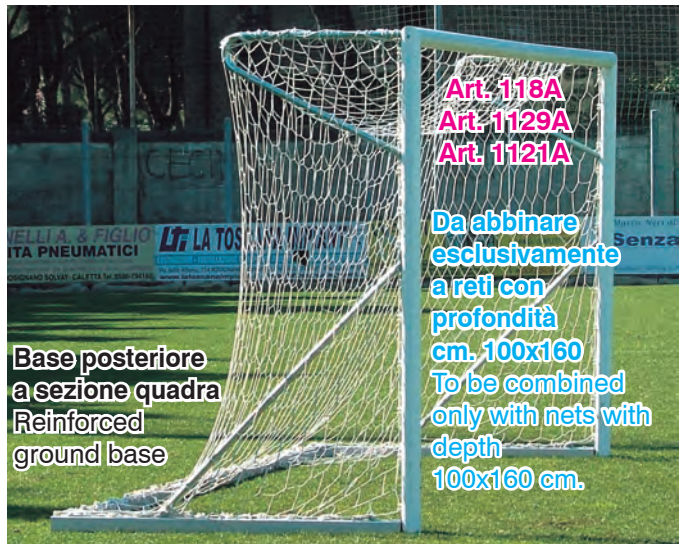

**Base posteriore a sezione quadra**  
 Reinforced ground base

Art. 118A  
 Art. 1129A  
 Art. 1121A

**Da abbinare esclusivamente a reti con profondità cm. 100x160**  
**To be combined only with nets with depth 100x160 cm.**

**LE PORTE TRASPORTABILI IN FASE DI GIOCO DEVONO ESSERE ZAVORRATE SULLA BASE POSTERIORE O FISSATE A TERRA CON PICCHETTI PER MOTIVI DI SICUREZZA. LE RUOTE GOMMATE SONO OPTIONAL**  
 Transportable goals must always be anchored to the ground by sacs of sand or metal pegs, for safety reasons. Wheels are optional



**Art. 120-R**  
**Coppia ruote per porte trasportabili ridotte Art. 118A, 1129A, 1121A**  
 Pair of wheels for reduced size transportable goals Art. 118A, 1129A, 1121A

pg.26



**Art. 4640**  
**Coppia ruote per porte trasportabili ridotte Art. 114-T, 118-G, 116-TDV, 120-TG**  
 Pair of wheels for reduced size transportable goals Art. 114-T, 118-G, 116-TDV, 120-TG



**Le porte ridotte sono disponibili anche nel modello fisso con bussole e pali da interrare**  
 Available also fixed models with underground sockets



**Art. 119G**  
**Art. 120-G**

Da abbinare esclusivamente a reti con  
profondità cm. 100x160  
To be combined only with nets with  
depth 100x160 cm.

**Art. 119G** Coppia Porte m. 5 x 2 a traversa divisa  
in acciaio trasportabili tubo 80 mm.  
Pair of Goals m. 5 x 2 crossbar in 2 pieces in painted steel,  
transportable, pipe 80 mm.

**Art. 120-G** Coppia Porte m. 6 x 2 a traversa divisa  
in acciaio trasportabili tubo sezione 80 mm.  
Pair of Goals m. 6 x 2 crossbars in 2 pieces  
in painted steel, transportable, pipe 80 mm.

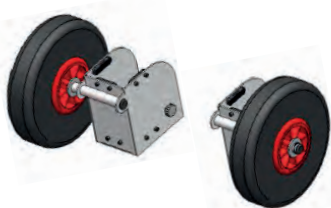

pg.25

**Art. 241C** Chiave per kit  
di fissaggio Art. 240AF  
Key for ground anchoring  
kit Art. 240AF



**Art. 240RU** Coppia ruote  
gommate con staffa per porte  
Art. 119G/120-G  
Pair of wheels for transportable  
goals Art. 119G/120-G

**Art. 240AF** Kit di fissaggio a  
terra per porte Art. 119G/120-G  
Ground anchoring kit for  
transportable goals  
Art. 119G/120-G

**ATTENZIONE:**  
in caso di ordine errato da parte del Cliente  
le porte, una volta consegnate,  
non possono essere rese



**Art. 122G**  
**Art. 121G**

pg.26

**Art. 122G**  
**Coppia Porte Calcetto m. 3 x 2 trasportabili**  
in acciaio verniciato tubo sezione 80 mm.  
Pair of Goals m.3x2 transportable in painted steel pipe 80 mm.

**Art. 121G**  
**Coppia Porte Calcetto m. 3 x 2 trasportabili**  
in lega leggera tubo sezione 80 mm.  
Pair of Goals m.3x2 transportable in light alloy pipe 80 mm.

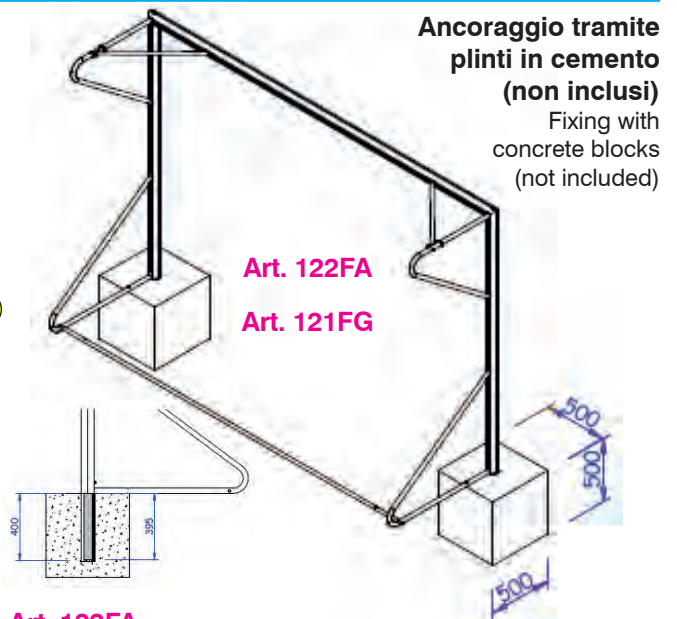

**Ancoraggio tramite  
plinti in cemento  
(non inclusi)**  
Fixing with  
concrete blocks  
(not included)

**Art. 122FA**  
**Coppia Porte Calcetto m. 3 x 2 fisse con bussole da**  
interrare in acciaio verniciato tubo 80 mm.  
Pair of Goals m.3x2 fixed in painted steel pipe 80 mm.

**Art. 121FG**  
**Coppia Porte Calcetto m. 3 x 2 fisse con bussole da**  
interrare in lega leggera tubo 80 mm.  
Pair of Goals m.3x2 fixed in light alloy pipe 80 mm.

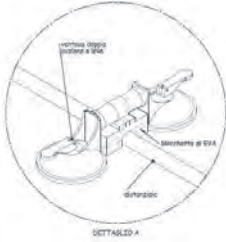

**Art. VTCL**

**Ventosa doppia per ancoraggio a terra porte calcetto su superfici indoor lisce (si consigliano 2 kit per ciascuna porta)**  
 Ground anchoring suckers for reduced goals to be used upon indoor smooth floors (it takes 2 kits for every goal)

pg.26



**Art. DSSCE**

**Sacco zavorra vuoto (da riempire con sabbia) per ancoraggio porte trasportabili regolamentari e ridotte**  
 Empty Ballast Bag (to be filled with sand) for goal anchoring



**Art. DSS20**

**Sacco zavorra kg. 20 (riempito con sabbia) per ancoraggio porte trasportabili regolamentari e ridotte**  
 Ballast Bag weight 20 Kg. for goal anchoring

**Art. PC04**

**Picchetto in acciaio per ancoraggio di porte ridotte con distanziale sottile su terreno naturale**  
 Steel anchoring hook for reduced soccer goals with thin pipe ground bases

**Art. AM01.7/.../AM01.3**

**TUBO ZAVORRA in PVC diametro 50 mm. atossico, flessibile, modellabile, appesantito da composto ecologico (peso 6 Kg. per metro) resistente alle alte e basse temperature e ai raggi ultravioletti per porte ridotte mt. 3x2/4x2/5x2/6x2 e regolamentari sia fisse che trasportabili**

pg.26

Weighted soft pipe 50 mm. diameter (6 Kg. per meter) resistant to high/low temperatures and ultra violet rays for safe anchoring of transportable goals m. 3x2/4x2/5x2/6x2 and official size goals to the ground



**Art. 353.G10**

**Serie 100 ganci reggirete di ricambio modello a rotazione per porte regolamentari o ridotte**  
 100 spare Net Holders rotating model for regular and reduced goals



**Art. 353.G13**



**Art. AS8060**

**Serie 100 ganci reggirete di ricambio da fissare con viti**  
 100 spare Net Holders

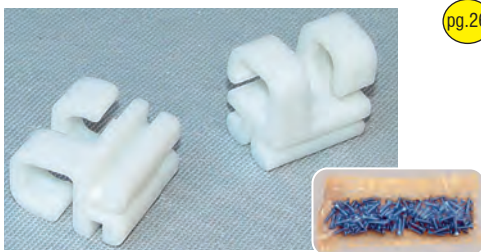

pg.26

**Art. 353 Serie 100 ganci reggirete di ricambio modello con vite per porte regolamentari o ridotte**  
 100 spare Net Holders with screws for regular and reduced goals



**Art. V590010**

**Serie 100 ganci reggirete di ricambio**  
 100 spare Net Holders

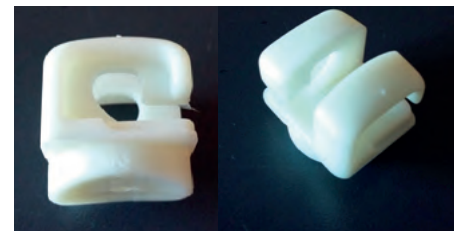

**Art. V680011 Serie 100 ganci reggirete di ricambio a base rotonda da fissare con viti**  
 100 spare Net Holders

**ATTENZIONE: verificate la tipologia dei ganci delle Vostre porte prima di ordinare i ricambi**  
 Please check the model of your holders before ordering spares



**Art. GFG**

**Gancio reggirete di ricambio in ferro con piastrina**  
 Spare iron Net Holder



**Art. SC1051**

**Serie 100 ganci reggirete di ricambio**  
 100 spare Net Holders



**Art. 110BAG**

**Serie 60 ganci reggirete di ricambio**  
 60 spare Net Holders



pg.26

Ideale per uso  
privato  
Not for official  
matches

**Art. SG176**  
**Porta m. 3x2 trasportabile  
in ferro verniciato,  
tubo sezione mm. 32  
completa di rete, ganci e  
picchetti**  
3x2 meter transportable  
Goal in painted iron, pipe  
section 32 mm. complete  
with net and anchor pegs



pg.26

Ideale per uso  
privato  
Not for official  
matches

**Art. 500SG**  
**Porta m. 3x2 trasportabile  
in ferro verniciato,  
tubo sezione mm. 50  
completa di rete, ganci e  
picchetti**  
3x2 meter transportable  
Goal in painted iron, pipe  
section 50 mm. complete  
with net and anchor pegs

**ATTENZIONE: in caso di ordine errato da parte del Cliente  
le porte, una volta consegnate, non possono essere rese**

**PORTE BIFRONTALI in lega leggera dimensioni m. 3x2 - 4x2 - 6x2**

Available 2 SIDE GOALS in light alloy dimensions m. 3 x 2 - 4 x 2 - 6 x 2

pg.27



**Art. 084.8**  
**Porta bifrontale  
m. 4 x 2  
in lega leggera  
sezione tubo 80 mm.  
completa di rete**  
Two Side Goal  
4 x 2 m. in light alloy  
pipe 80 mm.  
net included

**Art. 083**  
**Porta bifrontale  
m. 6 x 2  
in lega leggera  
sezione tubo 80 mm.  
completa di rete**  
Two Side Goal  
6 x 2 m. in light alloy  
pipe 80 mm.  
net included



## MINIPORTE Mini-goals



**Art. F214**  
Coppia porte minicalcio professionali in acciaio verniciato tubo sezione mm. 80 dimensioni m. 1,5 x 1 complete di reti  
Pair of professional steel mini football goals pipe 80 mm. dimensions 1,5 x 1 m. nets included



pg.27

**Art. F218**

Coppia porte minicalcio professionali in acciaio verniciato tubo sezione mm. 80 dimensioni cm. 90x60 complete di reti  
Pair of professional steel mini football goals pipe 80 mm. dimensions 90x60 cm. nets included

**ATTENZIONE:** in caso di ordine errato da parte del Cliente le porte, una volta consegnate, non possono essere rese



**Art. 123C**

Coppia porte minicalcio in acciaio verniciato m. 1,5 x 1 complete di reti e picchetti  
Pair of mini football goals 1,5 x 1 m. in painted steel pegs and nets included



**Art. 123F**

Coppia porte minicalcio in acciaio verniciato m. 1,5 x 1 complete di reti e picchetti  
Pair of mini football goals 1,5 x 1 m. in painted steel pegs and nets included

pg.27

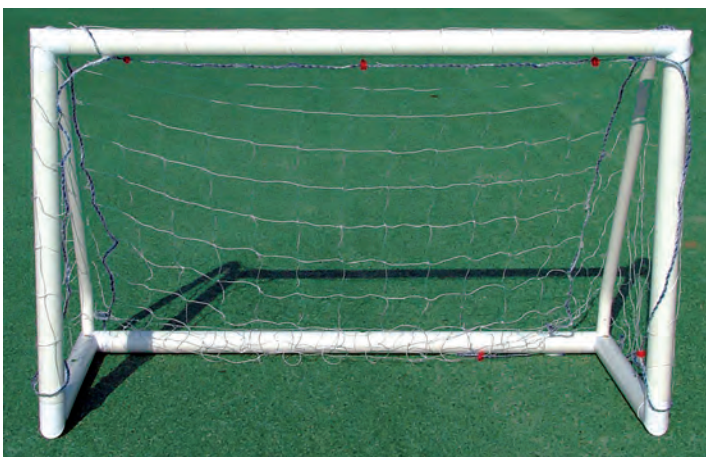

**Art. 124C**

Coppia porte minicalcio m. 1,5 x 1,1 in PVC rinforzato tubo Ø mm. 70 complete di reti e picchetti  
Pair of PVC mini football goals 1,5 x 1,1 m. pipe Ø 70 mm. pegs and nets included





**Art. 124**  
**Coppia porte minicalcio in polipropilene**  
**m. 1,5 x 1,1 tubo Ø mm. 40 complete di reti**  
Pair of polypropylene mini football goals 1,5 x 1,1 m.  
pipe Ø 40 mm. - nets included



**Dimensioni porta ribaltata m. 1,5 x 0,80**  
Goal upside down dimensions 1,5 x 0,80 m.



**Art. A124**  
**Coppia porte minicalcio in alluminio m. 1,5 x 1,1**  
**tubo Ø mm. 32 complete di reti**  
Pair of aluminium mini football goals 1,5 x 1,1 m.  
pipe Ø 32 mm. - nets included



**Dimensioni porta ribaltata m. 1,5 x 0,80**  
Goal upside down dimensions 1,5 x 0,80 m.

pg.27



**Art. PUG**  
**Coppia porte minicalcio in nylon**  
**m. 1,83 x 1,07**  
**complete di reti,**  
**picchetti e borsa**  
Pair of nylon mini football goals  
1,83 x 1,07 m.  
nets, pegs and bag included

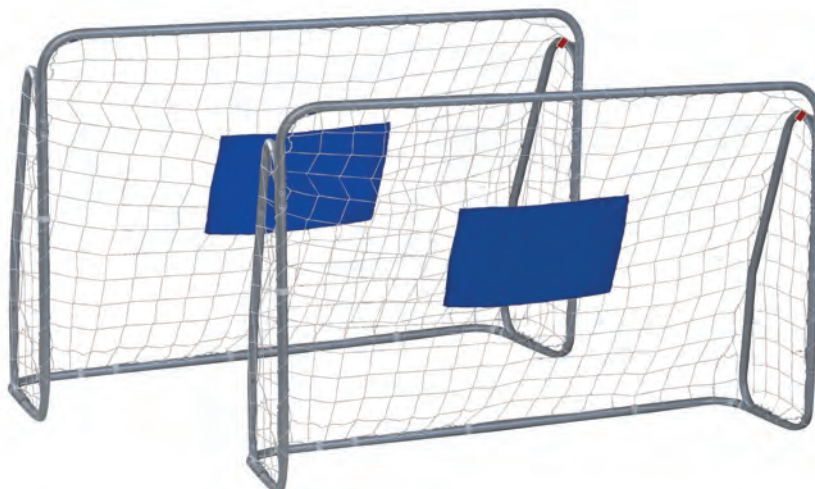

**Art. POR-14**  
**Coppia porte minicalcio**  
**m. 2,15 x 1,52 in acciaio verniciato**  
**complete di reti**  
Pair of steel mini football goals  
2,15 x 1,52 m. - nets included

## PORTA MINICALCIO CM.150x90 PIEGHEVOLE - Foldable 150x90 cm. mini football goal



pg.27

Art. BG150

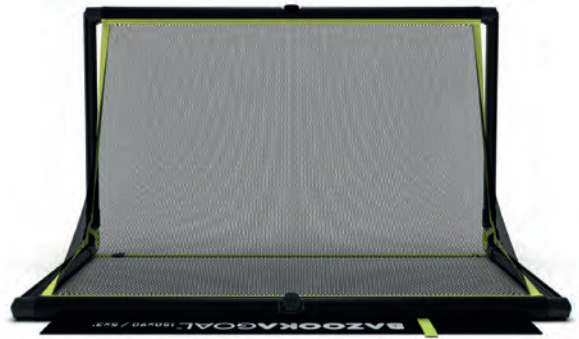

Questa porta minicalcio pieghevole consente ad allenatori e giocatori di concentrarsi sugli esercizi fondamentali poiché per il montaggio sono richiesti solo 10 secondi. Il telaio facilmente trasportabile è durevole, sicuro e realizzato con una struttura in PVC resistente al calore. Esso è dotato di bobine progettate per tornare in posizione dopo una pallonata e, soprattutto, la porta rimane stabile senza necessità di ancoraggio a terra grazie al sistema a molla integrato.

A differenza di molte porte da calcio in metallo comunemente usate, questa porta minicalcio in PVC è totalmente sicura e previene il rischio di infortuni qualora un giocatore andasse a sbatterci contro.

La rete della porta a tecnologia telescopica brevettata può essere personalizzata. È possibile infatti stamparvi il logo della propria squadra di modo che la porta diventi un utile strumento di marketing per le società sportive, ma anche per i partners esterni delle società stesse che desiderano investire in sponsorizzazioni smart.

La porta minicalcio pieghevole può essere utilizzata sulle diverse tipologie di superfici (erba, sabbia, cemento, legno). Non ha bisogno di borsa dato che la sua resistente rete funge anche da rivestimento.

La porta minicalcio da 150 cm x 90 cm si riduce ad una dimensione compatta di 180 cm x 15 cm x 10 cm, e le comode cinghie rendono il trasporto agevole visto che il peso è di soli 7 chilogrammi.

Le porte minicalcio pieghevoli vengono utilizzate quotidianamente presso alcune delle più rinomate accademie e scuole calcio di club professionistici tra cui Chelsea, Barcellona, Ajax, Arsenal, Manchester United, Liverpool ed Everton. Sono approvate e raccomandate dalla Federcalcio catalana in Spagna, dalla Federazione norvegese, nonché dall'Oregon Youth Soccer Association.

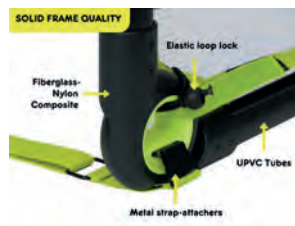

SI INSTALLA  
IN 10 SECONDI  
READY IN 10  
SECONDS

LEGGERA E  
COMODA PER  
IL TRASPORTO  
LIGHT AND  
COMFORTABLE  
FOR TRANSPORT

CON RETE  
PERSONALIZZABILE  
WITH  
CUSTOMIZABLE  
NET



This foldable mini football goal allows coaches and players to focus on core exercises as only 10 seconds are required for assembly. The easily transportable frame is durable, safe and made with a heat resistant PVC construction. It's equipped with coils designed to return to position after a ball hit and, above all, the goal remains stable with no need to be anchored to the ground thanks to the integrated spring system.

Unlike many commonly used metal soccer goals, this PVC mini football goal is totally safe and prevents the risk of injury should a player bump into it.

The patented telescopic goal net can be customized. In fact, it's possible to print the logo of your team so that the goal becomes a useful marketing tool for sports clubs, but also for external partners who wish to invest in smart sponsorships.

The foldable mini football goal can be used on different surfaces (grass, sand, concrete, wood). It does not need a bag as its durable net also acts as a covering.

The 150 cm x 90 cm mini football goal is reduced to a compact size of 180 cm x 15 cm x 10 cm, and the comfortable straps make transport easy as the weight is only 7 kilograms.

Foldable mini football goals are used daily at some of the most renowned academies and soccer schools of professional clubs including Chelsea, Barcelona, Ajax, Arsenal, Manchester United, Liverpool and Everton. They are approved and recommended by the Catalan Football Association in Spain, the Norwegian Federation, as well as the Oregon Youth Soccer Association.



**RETI REGOLAMENTARI colore bianco - White color official size Nets**

Le reti a maglia esagonale sono tessute, quelle a maglia quadrata sono annodate (eccetto Art. B011) Square mesh nets are knotted (except Art. B011)

**Profondità: la prima grandezza indica la sporgenza posteriore della rete ad altezza traversa, la seconda grandezza indica la sporgenza posteriore a terra**  
 Depth: the first figure indicates the rear depth of the net at crossbar level, the second figure indicates the rear depth at ground



**Art. B011**  
 polipropilene mm.5  
 maglia mm.120 mesh  
 colore bianco  
 white  
 certificate FIGC/LND  
 certified  
 profondità  
 cm.200x200 depth

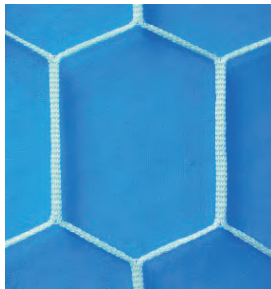
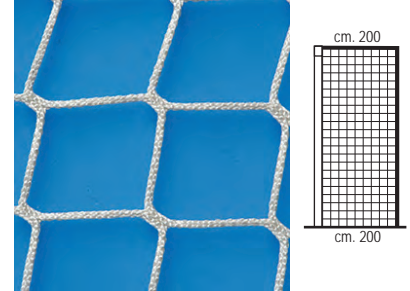

**Art. 125**  
 polipropilene mm. 4  
 profondità  
 cm.170x170 depth

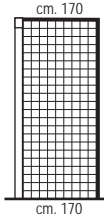

pg.27 pg.28

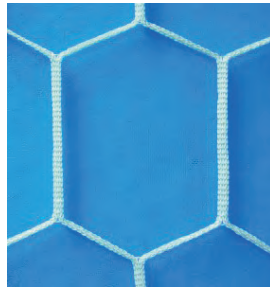

**Art. 126**  
 poliestere mm. 5  
 profondità  
 cm.100x200 depth

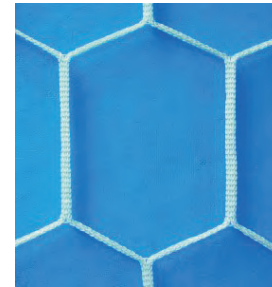
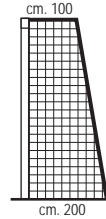

**Art. 127**  
 polipropilene mm. 5  
 profondità  
 cm.200x200 depth

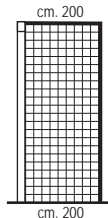

**Art. B003**  
 polietilene  
 mm. 2,5  
 profondità  
 cm.170x170  
 depth

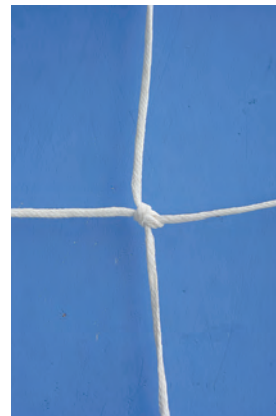
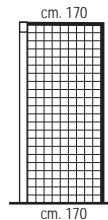

**Art. B19**  
 polietilene  
 mm. 3,5  
 profondità  
 cm.100x200  
 depth

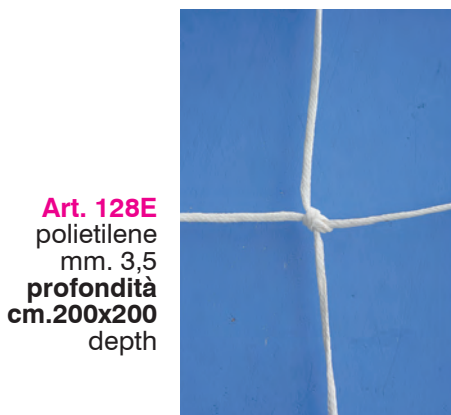
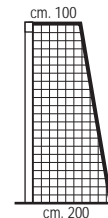

**Art. 128E**  
 polietilene  
 mm. 3,5  
 profondità  
 cm.200x200  
 depth

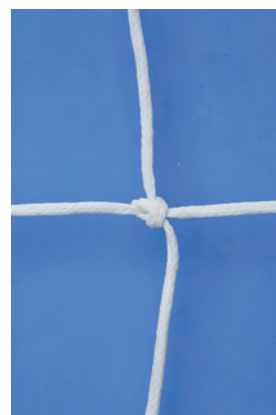
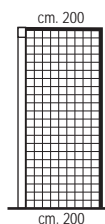

**Art. 128**  
 polietilene  
 mm. 4,5  
 profondità  
 cm.200x200  
 depth

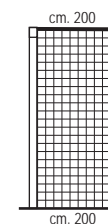



Art. 128FR

**RETI REGOLAMENTARI colorate**  
**Striped official size Nets**

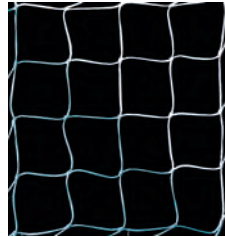
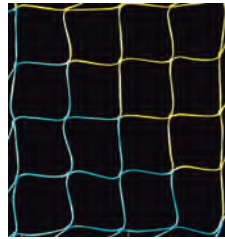

**Art. 128FR** Coppia reti annodate in polietilene mm.4 bianche o a strisce colorate (bianco/royal, bianco/rosso, giallo/royal) profondità cm.100x250 depth  
Pair of nets polyethylene 4 mm. color stripes, knotted (available in white, white/royal, yellow/royal, white/red)

pg.28

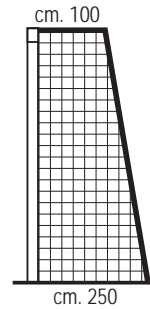

**Art. 128C** Coppia reti annodate in polietilene mm. 3,5 a strisce colorate (bianco-royal, bianco/rosso, giallo/royal, rosso/blu, bianco/nero, bianco/verde) profondità cm. 200x200 depth  
Pair of nets polyethylene 3,5 mm. color stripes, knotted (available in white/royal, yellow/royal, white/red, white/black, white/green, red/blue)

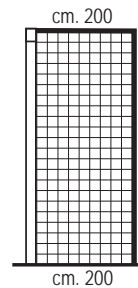

**Art. 129T**  
**Coppia reti polipropilene mm. 4 annodate a mano a strisce colorate (bianco/viola, rosso/nero, giallo/rosso, giallo/verde, giallo/nero, arancio, tricolore Italia, Tim Cup a strisce verticali) profondità cm. 200x200 depth**  
Pair of nets with color stripes, hand knotted in various combinations



**Art. 129T.SP**  
**Coppia reti polipropilene mm. 4 annodate a mano a strisce colorate (qualsiasi combinazione di colori a richiesta) profondità cm. 200x200 depth**  
Pair of nets with color stripes, hand knotted any combination

**RETI RIDOTTE - Reduced size Nets - m.6x2,2/m.6,5x2,5**

**Art. 131.22**  
**Coppia Reti m. 6x2,2 annodate in polietilene mm. 3,5 profondità cm.100x160**  
Pair of knotted nets 6x2,20 m. polyethylene thickness 3,5 mm. 100x160 cm. depth

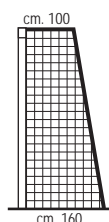
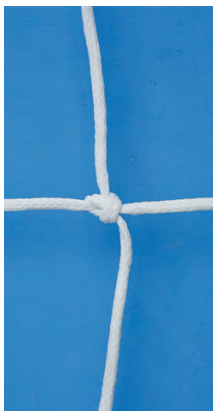

pg.28

**Art. 131.5**  
**Coppia Reti m. 6,50x2,50 in polipropilene mm. 4 profondità cm.120x120**  
Pair of nets 6,50x2,50 m. polypropylene thickness 4 mm. 120x120 cm. depth

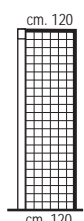
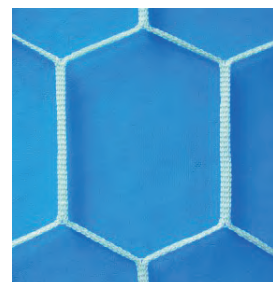

## RETI RIDOTTE - Reduced size Nets - m.6x2/m.5x2/m.4x2

**Profondità: la prima grandezza indica la sporgenza posteriore della rete ad altezza traversa, la seconda grandezza indica la sporgenza posteriore a terra**  
**Depth: the first figure indicates the rear depth of the net at crossbar level, the second figure indicates the rear depth at ground**

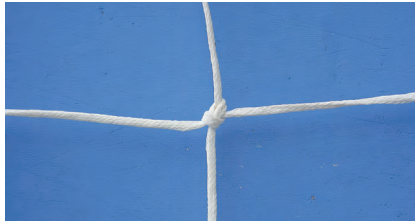

**Art. 131N m. 6x2 / Art. 132N m. 5x2**  
**Coppia Reti annodate in polietilene mm. 2,5 profondità cm.120x120**  
 Pair of knotted nets 6x2 m. / 5x2 m. polyethylene thickness 2,5 mm. 120x120 cm. depth

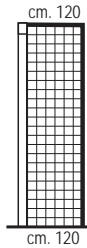

pg.28

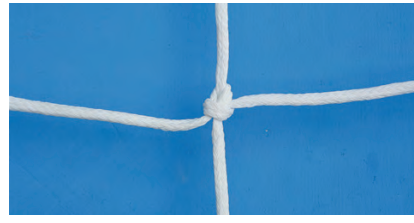

**Art. B170 m. 6x2 / Art. B171 m. 5x2**  
**Coppia Reti annodate in polietilene mm. 3,5 profondità cm.100x160**  
 Pair of knotted nets 6x2 m. / 5x2 m. polyethylene thickness 3,5 mm. 100x160 cm. depth

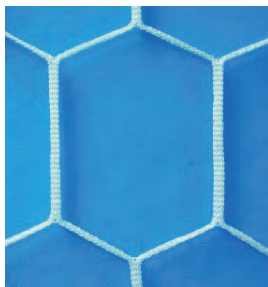
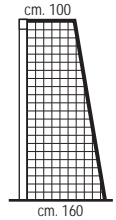

**Art. 133 Coppia Reti m. 4x2 in polipropilene mm. 4 profondità cm. 120x120**  
 Pair of nets 4x2 m. polypropylene thickness 4 mm. 120x120 cm. depth

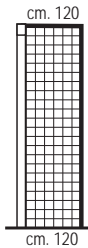

pg.28

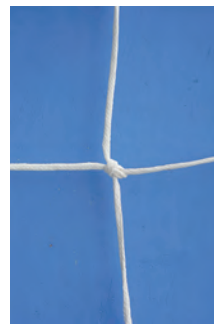

**Art. 133SN Coppia Reti m. 4x2 annodate in polietilene mm. 2,5 profondità cm. 100x100**  
 Pair of knotted nets 4x2 m. polyethylene thickness 2,5 mm. 100x100 cm. depth

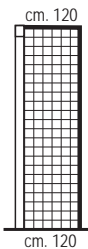
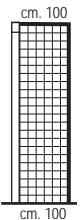

**Art. 133LR Coppia Reti m. 4x2 annodate in polietilene spessore mm. 3,5 profondità cm.120x120**  
 Pair of knotted nets 4x2 m. polyethylene thickness 3,5 mm. 120x120 cm. depth

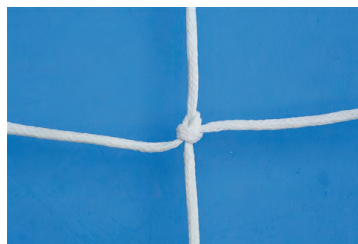

**Art. 133NP Coppia Reti m. 4x2 annodate in polietilene spessore mm. 3,5 profondità cm.100x160**  
 Pair of knotted nets 4x2 m. polyethylene thickness 3,5 mm. 100x160 cm. depth

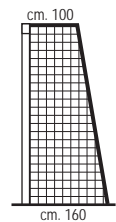

## RETI RIDOTTE COLORATE - Striped reduced size Nets - m.6x2/m.5x2/m.4x2



**Art. 62BR m.6x2 profondità cm.100x160 depth**  
**Art. 52BR m.5x2 profondità cm.100x160 depth**  
**Art. 42BR m.4x2 profondità cm.120x120 depth**  
**Coppia Reti a maglia esagonale in polipropilene ø mm. 4 colorate a strisce bianco/rosse**  
 Pair of white/red nets polypropylene thickness 4 mm. hexagonal mesh

pg.28

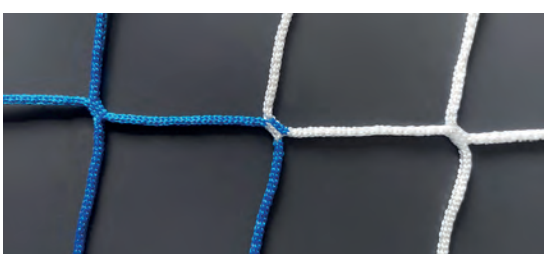
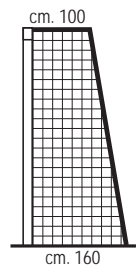

**Art. 62BA m.6x2 profondità cm.100x160 depth**  
**Art. 52BA m.5x2 profondità cm.100x160 depth**  
**Art. 42BA m.4x2 profondità cm.120x120 depth**  
**Coppia Reti a maglia quadrata in polipropilene ø mm. 4 colorate a strisce bianco/azzurre**  
 Pair of white/royal nets polypropylene thickness 4 mm. square mesh

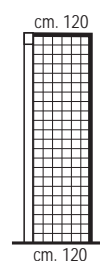

**RETI CALCETTO - Futsal Nets m. 3x2**

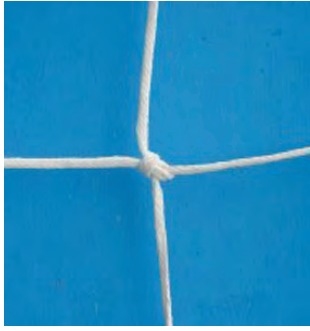

**Art. 134E**  
Coppia reti m.3x2 annodate in polietilene spessore mm.2,5  
Pair of 3x2 m. nets knotted polyethylene thickness 2,5 mm.

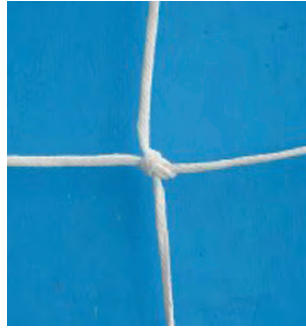

**Art. 135C**  
Coppia reti m.3x2 annodate in polietilene spessore mm.3,5  
Pair of 3x2 m. nets knotted polyethylene thickness 3,5 mm.

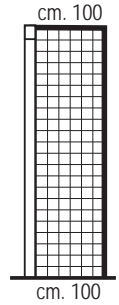

pg.29

**Profondità cm.100x100**  
Depth: 100x100 cm.

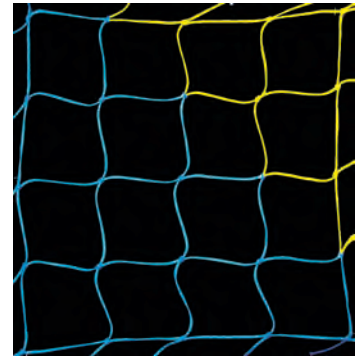
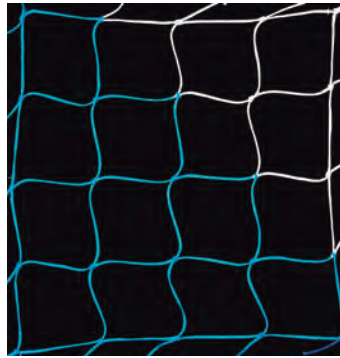

**Art. 135FR** Coppia reti m.3x2 annodate in polietilene spessore mm.3 colori: bianco/royal, bianco/rosso, giallo/royal  
Pair of 3x2 m. nets knotted polyethylene thickness 3 mm. colors: white/royal, white/red, yellow/royal

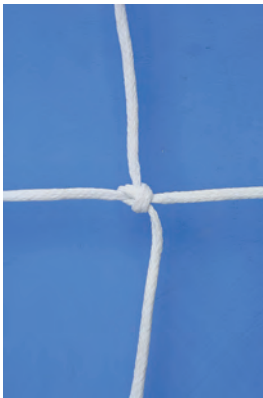

pg.29

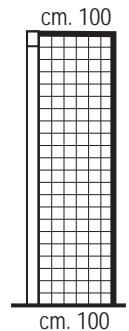

**Art. 135** Coppia reti m.3x2 annodate in polietilene spessore mm.4,5 colori: bianco, rosso, giallo  
Pair of 3x2 m. nets knotted polyethylene thickness 4,5 mm. colors: white, red, yellow



pg.29

**Art. 137**  
Coppia reti **m.1,5x1,1** per porte minicalcio  
Pair of nets 1,5x1,1 m. for mini football goals

## RETI PER CALCI DI PRECISIONE - Precision shooting nets

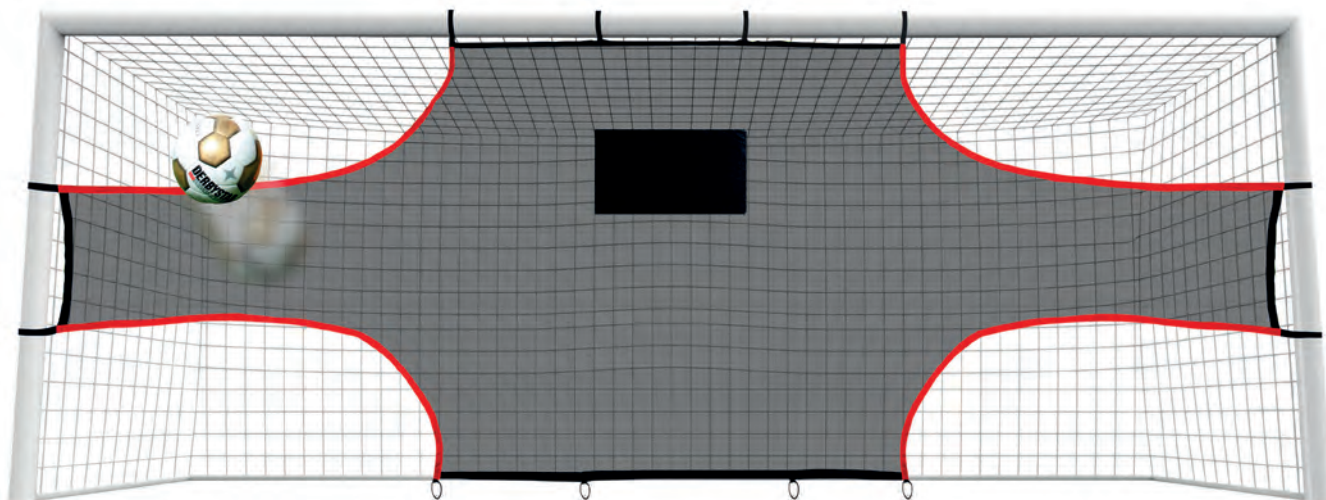

**Art. PTI.732**

**Rete per calci di precisione per porta regolamentare completa di fasce con velcro per fissaggio a pali e traversa e picchetti per ancoraggio a terra**  
Precision shooting net for regular size goal complete with velcro straps for fixing to poles and crossbar and pegs for ground anchoring

● pg.29

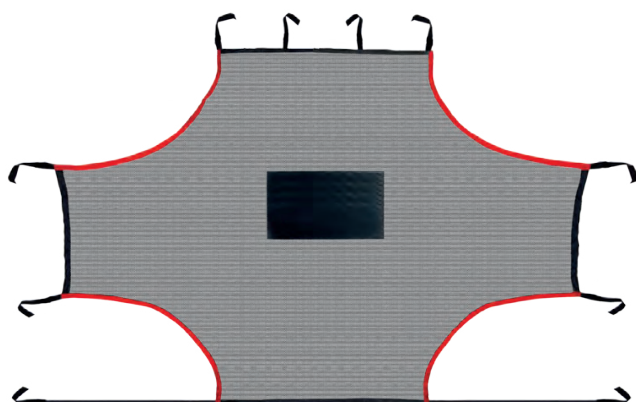

**Art. PTI.275**

**Rete per calci di precisione per porta m.3x2 completa di fasce con velcro per fissaggio a pali e traversa e picchetti per ancoraggio a terra**  
Precision shooting net for 3x2 m. goal complete with velcro straps for fixing to poles and crossbar and pegs for ground anchoring

● pg.29

**Art. PTI.520**

**Rete per calci di precisione per porta m.5x2 completa di fasce con velcro per fissaggio a pali e traversa e picchetti per ancoraggio a terra**  
Precision shooting net for 5x2 m. goal complete with velcro straps for fixing to poles and crossbar and pegs for ground anchoring

● pg.29

**4 tasche bersaglio per calci di estrema precisione**



**4 target pockets for very accurate shootings**

*Basta raccogliere palloni in fondo al sacco, lascia che sia la palla a tornare da te!*

*Stop picking up balls all the time, let the ball come back to you!*

**Art. GM**

**Rete per calci di precisione con 4 tasche per porta regolamentare completa di corda elastica e picchetti**  
Precision shooting net with 4 accuracy pockets including elastic rope and pegs for regular size goal

**Art. GM42**

**Rete per calci di precisione con 4 tasche per porta m. 4x2 completa di corda elastica e picchetti**  
Precision shooting net with 4 accuracy pockets including elastic rope and pegs for 4x2 m. goal



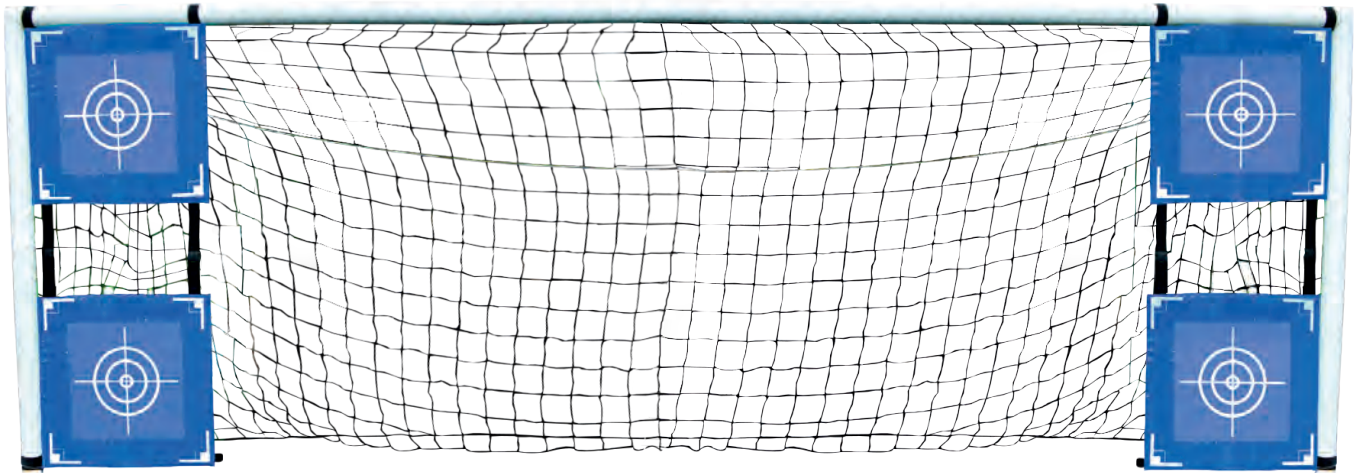

pg.29

**Art. SF4106**

**Set di 4 bersagli per calci di precisione applicabili a porte di qualsiasi dimensione**

Set of 4 targets for precision shooting applicable to soccer goals of any size

Particolare di un bersaglio  
Detail of a target

pg.7

**Art. QBFG**

**CROSS TRAINING**

**rete bersaglio sempre in piedi  
per allenamento alla precisione del cross,  
del lancio in profondità,  
del rinvio del portiere**

**CROSS TRAINING**

movable target to improve crossing,  
long passing and GK kicks precision

**Il bersaglio ha dimensioni cm.120x120,  
ha una inclinazione regolabile da  
orizzontale a quasi verticale ed è in grado  
di ricevere la palla ad altezze comprese  
tra cm.175 e cm.262**

**senza mai cadere a terra  
base in alluminio, peso Kg.10  
facilmente spostabile sul campo**

The basket is adjustable from horizontal to  
nearly vertical, height adjustable from 175  
to 262 cm. - aluminium base, weight 10 Kg.  
very easy to move on the field, never falls  
down when hit by the ball



## RETI DI PROTEZIONE - Protection nets



**TUTTE LE RETI DI PROTEZIONE VENGONO REALIZZATE SU MISURA IN BASE ALLE RICHIESTE DEL CLIENTE IN CIRCA 10 GIORNI**

All protection nets are manufactured according to Customer's needs in about 10 days



● pg.29



### **Art. 093N**

**Rete protezione polietilene verde annodata  
maglia cm. 13x13 spessore mm.2,5  
(per calcio e calcetto)**

Protection Net green polyethylene mesh  
13x13 cm. knotted, thickness 2,5 mm.  
(for football and futsal)

### **Art. 093.5**

**Rete protezione polietilene verde annodata  
maglia cm. 13x13 spessore mm.3,5  
(per calcio e calcetto)**

Protection Net green polyethylene mesh  
13x13 cm. knotted, thickness 3,5 mm.  
(for football and futsal)

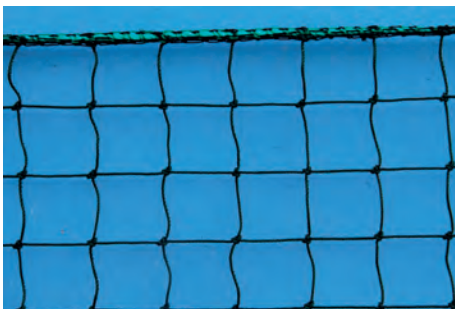

### **Art. 0934N**

**Rete protezione polietilene verde annodata  
maglia mm. 45x45 sp. mm.2  
(per tennis e baseball)**

Protection Net green polyethylene mesh  
45x45 mm. knotted, thick 2 mm.  
(for tennis and baseball)

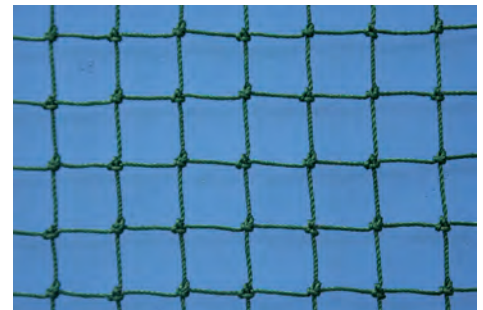

### **Art. R57**

**Rete protezione polietilene verde annodata  
maglia mm. 25x25  
spessore mm.2 (per golf)**

Protection Net green polyethylene mesh 25x25 mm. knotted thick 2 mm. (for golf)

### **Art. R55**

**Rete protezione polietilene nera annodata  
maglia mm. 18x18  
spessore mm.2  
(antioggetto/antipetardo)**

Protection Net anti-objects and fire crackers



## PANCHINE ALLENATORI - Trainers' dug-outs



**Art. V6230/.../V6234.8**  
Panchina allenatori  
profilo curvato  
mm. 50x30 in acciaio  
zincato a caldo  
rivestimento  
posteriore e laterale  
in policarbonato  
alveolare non  
trasparente spessore  
mm. 4,  
piano di seduta con  
scocche in  
polipropilene montate  
su telaio zincato  
Dug-out in galvanized  
steel with non  
transparent alveolar  
protection

Altezza tettuccio cm. 200, profondità fianco laterale cm. 88

pg.30

**Art. V6220/.../V6224.8**  
Panchina allenatori  
profilo curvato  
mm. 50x30 in acciaio  
zincato a caldo  
rivestimento  
posteriore e laterale in  
policarbonato  
trasparente spessore  
mm. 3, piano di seduta  
con scocche in  
polipropilene montate  
su telaio zincato  
Dug-out in galvanized  
steel with transparent  
alveolar protection



**Art. V6285**  
Protezione in poliuretano espanso  
per bordo panchina allenatori  
con profilo mm. 50x30  
Polyurethane protection for dug-out's edge



Altezza tettuccio cm. 200  
 profondità fianco laterale cm. 74  
 Roof height 200 cm. - side depth 74 cm.



**Art. 155AV/156AV/157AV/158AV/159AV/159.7AV/159.8AV/155AV4**  
 Panchina allenatori con struttura in tubo quadro in lega d'alluminio mm. 30x30 con copertura in policarbonato alveolare non trasparente - fianchi laterali in policarbonato trasparente (2 scocche di seduta in polipropilene per ogni metro di lunghezza)  
 Dug-out in light alloy square pipe mm. 30x30 with non transparent alveolar protection  
 Transparent protection on both sides (2 polypropylene seats per every meter of length)

● pg.31



**Art. 162**  
 Protezione in poliuretano per bordo panchine  
 Polyurethane protection for dug-out's edge



**Art. PSG1/PSG2/PSG3**  
 Piano di seduta con scocche in polipropilene montate su supporto in acciaio zincato da fissare a terra  
 (identico a quello fornito con le panchine allenatori serie Art. 155AV e Art. 155)  
 lunghezza m.1 con 2 scocche di seduta  
 lunghezza m.2 con 4 scocche di seduta  
 lunghezza m.3 con 6 scocche di seduta  
 Seating support mounted on a galvanized frame

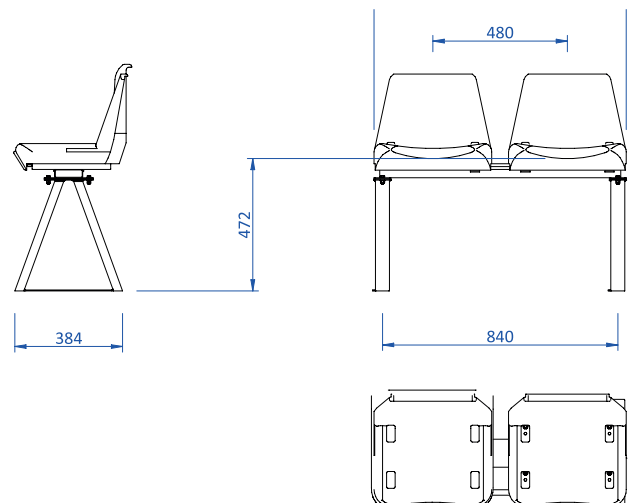
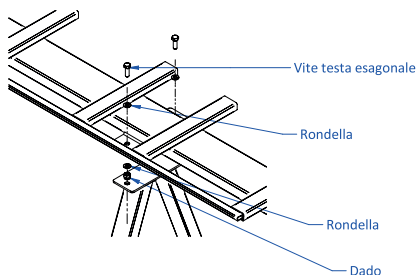



Altezza tettuccio cm. 200 profondità fianco laterale cm. 74  
Roof height 200 cm. - side depth 74 cm.



**Art. 155/156/157/158/159/159.7/159.8/155-4**

Panchina con struttura in tubo quadro in lega d'alluminio mm. 30x30 con copertura in policarbonato trasparente e scocche di seduta in polipropilene (2 scocche di seduta per ogni metro di lunghezza)  
Dug-out in light alloy square pipe mm. 30x30 with transparent polycarbonate protection  
(2 polypropylene seats per every meter of length) pg.31

La verniciatura con colore a richiesta del tubo quadro in alluminio comporta una maggiorazione del prezzo del 10%  
Optional painting of the square pipe frame in aluminium (color on request): 10% additional charge on selling price

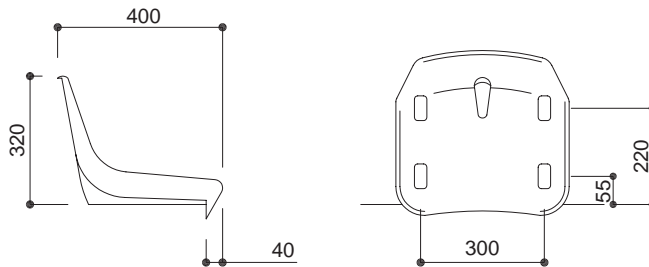

**Art. M2010**  
Seduta ricambio per panchina allenatori (nuovo modello) colore rosso o blu  
Spare Seat for Dug-Outs (new model) in red or blue color



**Art. ASBI**  
Seduta ricambio per panchina allenatori (vecchio modello) colore rosso o blu fissaggio con 4 viti  
Spare Seat for Dug-Outs (previous model) in red or blue color fixing with 4 screws

pg.31

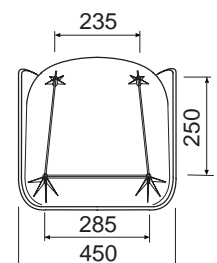
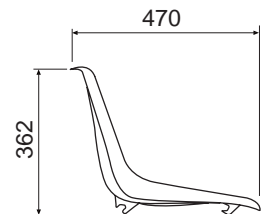

È necessario fissare le panchine su una base in cemento tramite tasselli; la base dovrà essere più estesa di circa 30 cm. per ciascun lato rispetto alla lunghezza e alla profondità della panchina  
It is necessary to anchor dug-outs upon concrete base. Size of concrete base must be about 60 cm. longer and deeper than dug-out perimeter size  
(30 cm. longer and wider on each of the 4 sides)

## PANCHINE ALLENATORI IDEALI PER CAMPI CALCETTO Trainers' dug-outs for futsal pitches



**Art. V6242.2 / V6242.3 / V6241.2 / V6241.3**

**Panchina allenatori profilo curvato mm. 40x20 in lega di alluminio, rivestimento posteriore e laterale in policarbonato alveolare sp. mm. 4 profondità a terra cm. 97, altezza massima cm. 208 lunghezza metri 2 oppure metri 3 con panca sedute in acciaio zincato e legno o con panca sedute in alluminio anodizzato**

Dug-out curved profile 40x20 mm. in light alloy, rear and side coverings in non transparent polycarbonate 4 mm. thick soil depth 97 cm. maximum height 208 cm. 2 meters or 3 meters length with wooden bench on galvanized steel or with bench in anodized aluminium



● pg.32

**Art. V6291 / V6292**

**Panchina allenatori trasportabile su ruote profilo curvato mm. 50x30 in lega di alluminio rivestimento posteriore e laterale in policarbonato alveolare sp. mm. 4 oppure in policarbonato trasparente sp. mm. 3, profondità a terra cm. 150 altezza utile cm. 210 lunghezza metri 3 con supporto sedute in acciaio zincato e 6 scocche in polipropilene con piano borse sul retro dei seggiolini**

Dug-out transportable on wheels curved profile 50x30 mm. in light alloy rear and side coverings in non transparent polycarbonate mm. 4 thick or in transparent polycarbonate mm. 3 thick, depth on the ground 150 cm. useful height 210 cm. length 3 meters with galvanized steel seat support and 6 polypropylene seats with back space for bags





**New!**



**Profondità fianco laterale cm.150**  
Side depth 150 cm.

**Ordinabile anche nel modello fisso  
senza ruote**  
Fixed model with no wheels on request

pg.32



**Art. V6293 / V6294**

**Panchina allenatori trasportabile su ruote lunghezza metri 3  
profilo curvato mm.50x30 in lega di alluminio - altezza utile cm.210  
copertura in policarbonato alveolare mm.4 oppure in policarbonato trasparente mm.3  
sedute su 2 file (11 posti in totale)**

Transportable dug-out on wheels length 3 meters  
aluminium alloy frame 50x30 mm. - height 210 cm.  
4 mm. non transparent polycarbonate cover or 3 mm. transparent polycarbonate cover  
seating in 2 rows (11 seats in total)



**Art. S04910**

**Panchina bordo campo  
struttura in acciaio zincato  
lunghezza cm. 200  
con 4 scocche di seduta in polipropilene colorato**  
4 Sideline seats on galvanized steel frame  
length 200 cm.

pg.42



**Art. 155FZ2/155FZ4/155FZ6/155FZ8**

**Panchina allenatori in acciaio zincato a caldo rinforzato profilo mm. 40x40 con profondità cm.180 (misurando da tettuccio a limite base posteriore di appoggio) rivestita con lastre in policarbonato trasparente spessore mm. 3 piano di seduta con scocche in polipropilene**

Dug-Out in galvanized steel pipe 40x40 mm. - 180 cm. depth (from back protection to edge of roof)  
transparent polycarbonate 3 mm. thick back cover - polypropylene seats on steel frame (2 seats each meter)



● pg.31 ● pg.32

**Art. 155PR**

**Rivestimento di protezione in schiumato per tettuccio e montanti**  
Soft edge protections



**Art. LXR2/LXR4/LXR6/LXR8**

**Panchina allenatori in tubo di acciaio zincato a caldo profilo mm. 40x40 TRASPORTABILE su ruote - copertura in policarbonato trasparente profondità cm. 135 piano di seduta con scocche in polipropilene**

Dug-Out in galvanized steel pipe 40x40 mm. - TRANSPORTABLE on wheels  
transparent polycarbonate back cover, polypropylene seats



## PANCHINE LUSO CON POLTRONE IN ECOPELLE - Leather seat dug-outs



**PREVENTIVO SU RICHIESTA  
PRICES ON REQUEST**



**Modelli fissi o trasportabili  
struttura in acciaio zincato  
poltrone in ecopelle personalizzabili**  
Fixed or transportable Dug-Outs  
galvanized steel frame  
customizable leather seats

## CARRELLI TRACCIALINEE - Line markers



**Per una resa ottimale e per evitare inconvenienti utilizzare sempre carbonato di calcio asciutto, ovvero la comune polvere di marmo**

For optimal performance always use dry calcium carbonate, that is the common marble dust

**Art. 142S**  
**Carrello traccialinee a polvere**  
Marble Powder Line Marker

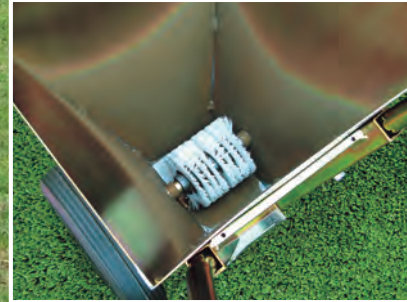

pg.29

**UTILIZZARE SOLTANTO VERNICE ECOLOGICA ATOSSICA E PULIRE DOPO OGNI USO IL SERBATOIO E TUTTO IL CIRCUITO DI SPRUZZO FINO AGLI UGELLI (occorre spruzzare ripetutamente acqua prima di riporre l'attrezzo)**  
Always use ecological paint and wash with water after use (put water in the tank and spray)



**Art. 144**  
**Carrello traccialinee a vernice ecologica con serbatoio munito di pompante a pressione manuale**  
Paint Line Marker with manual pressure tank



**New!**

pg.30

**Art. 145**  
**Carrello traccialinee a vernice ecologica con motore a scoppio a 4 tempi - marcatura CE serbatoio vernice litri 23 tracciatura laterale regolabile**  
Paint Line Marker with 4 stroke engine 23 liter tank



**Art. 144.EL**

**Carrello traccialinee a vernice elettrica completo di caricabatteria (per la batteria della pompa elettrica) capacità serbatoio litri 18 tracciatura laterale regolabile**

Electric Line Marker complete with battery charger 18 liter tank adjustable lateral marking device

pg.30

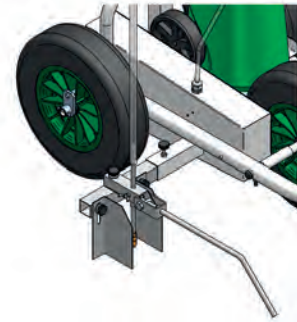

**Art. F211**

**Mirino in acciaio zincato per carrelli traccialinee Art. 144.EL e Art. 145**  
Foresight in galvanized steel for line markers Art. 144.EL and Art. 145

pg.29

**Art. 144.SL**

**Carrello traccialinee a rulli senza serbatoio a pressione.**

**Tramite la rotazione dei rulli la vernice viene prelevata all'interno del serbatoio e spalmata sull'erba**

Roller Paint Line Marker

Just fill up the tank with paint and push the machine.

Taking advantage of rolling wheels, paint flows from tank down to grass the easiest way!





**Art. 146E**

**Vernice Ecologica atossica per manti erbosi**  
**Biancostadio lt. 17 - Kg. 19**  
 Ecological Paint for grass 17 liters - 19 Kg.

**Art. 146BP/146BPG**

**Vernice bianca o gialla per manti sintetici a bassa permanenza (1 settimana) 17 litri**  
 Paint for artificial grass white or yellow color, short durability (1 week) 17 liters



**Art. 146LP/146LPG**

**Vernice bianca o gialla per manti sintetici a lunga permanenza (3 mesi) 17 litri, da utilizzare solo con carrello a rulli**  
 Paint for artificial grass white or yellow color, long durability (3 months) 17 liters

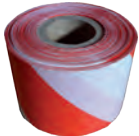

**Art. NS200**

**Rotolo nastro stradale mt. 200 - bianco/rosso**  
 Red/White Tape length 200 meters



**Art. PFIx Plifix**

**Picchetto di riferimento permanente con erba sintetica bianca o colorata per agevolare la tracciatura delle righe dei campi da gioco o per delimitare aree**  
**Confezione da 25 pezzi incluso utensile in plastica**  
 Plifix - permanent peg with artificial white or coloured grass to help tracing lines on the field or mark areas - 25 pieces set includes also plastic planting device



pg.30



**Art. NTESA**

**Rotolo Nastro adesivo mt. 50 - larghezza cm. 5 vari colori per tracciatura righe su superfici sintetiche**  
 Tape for bounds 50 meter - 5 cm. width

**Art. SIFS**

**Fettuccia segnasettore in materiale sintetico impermeabile colore bianco o rosso larghezza mm. 50 in rotoli da mt. 25 (chiodi inclusi)**  
 Sector line in waterproof synthetic fabric, width 50 mm. length 25 m. color white or red (pegs included)



**New!**



**Art. RC100**

**Bobina con fettuccia elastica per delimitazione temporanea campo da gioco.**

Con questo nastro la marcatura può essere comodamente installata su campi senza gesso o vernice, e può essere rimossa senza lasciare residui dopo una partita o un allenamento. Il nastro può essere facilmente srotolato dalla bobina, e poi riavvolto con la stessa facilità. Lunghezza 100 metri (ma può estendersi fino a circa il doppio)

**Larghezza cm. 2,5 - colore bianco**  
**25 picchetti in plastica inclusi per il fissaggio**

Spool with elastic tape for temporary delimitation of the playing field. With this tape the marking can be conveniently installed on pitches with no chalk or paint, and can be removed without leaving residue after a match or training. The tape can be easily unwound from the spool, and then rewound just as easily.

Length 100 meters (but can extend to approximately double that)

Width 2,5 cm. - white color  
 25 plastic pegs included for fixing

## SEDUTE PER GRADINATE - Stadium seats

**COLORI DISPONIBILI: blu, rosso, giallo, verde, bianco, nero, grigio**  
**AVAILABLE COLORS: blue, red, yellow, green, white, black, grey**

**ORDINE MINIMO 10 PEZZI PER MODELLO E COLORE**  
 Minimum quantity 10 pieces per model and color

**ATTENZIONE:  
 NON PER PANCHINE  
 ALLENATORI!  
 NOT FOR TRAINERS'  
 DUG-OUTS!**



**Art. M2003/M2003A**

**Art. M2003** Seduta in polipropilene con schienale ignifuga e antiultravioletti (secondo normativa UEFA) fissaggio diretto sulla gradinata con tasselli (non inclusi)  
 Polypropylene Seat non ignitable and anti-ultraviolet rays with back rest (according to UEFA requirements) to be fixed with screws (not included)

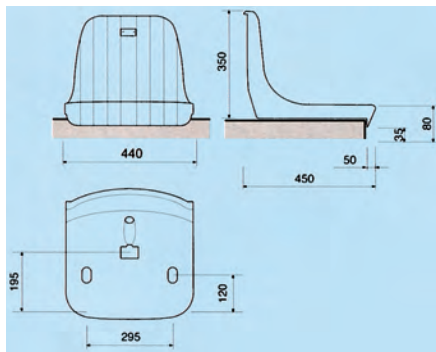
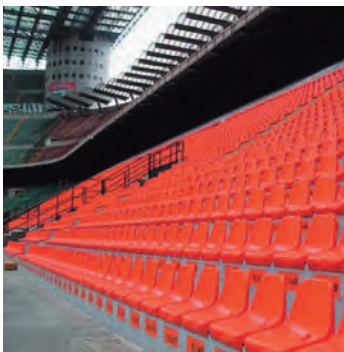

**Art. M2003A** Seduta in polipropilene con schienale come Art. M2003 solo antiultravioletti, fissaggio diretto sulla gradinata con tasselli (non inclusi)  
 Polypropylene Seat as Art. M2003 anti-ultraviolet rays, with back rest to be fixed with screws (not included)

pg.32

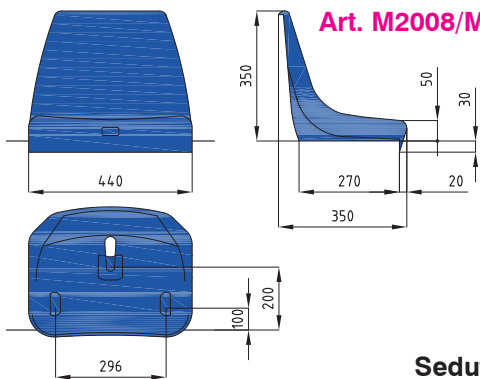

**Art. M2008/M2008A**



**Seduta in polipropilene con schienale ignifuga e antiultravioletti Art. M2008 oppure solo antiultravioletti Art. M2008A - fissaggio diretto sulla gradinata con tasselli (non inclusi)**  
 Polypropylene Seat non ignitable and anti-ultraviolet rays **Art. M2008** or only anti-ultraviolet rays **Art. M2008A** with back rest to be fixed with screws (not included)

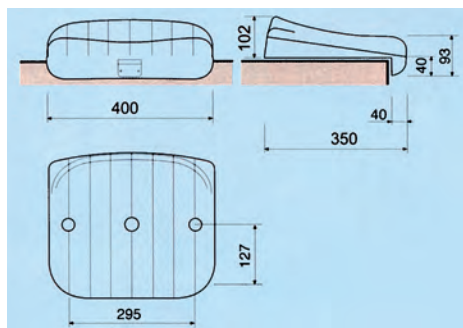
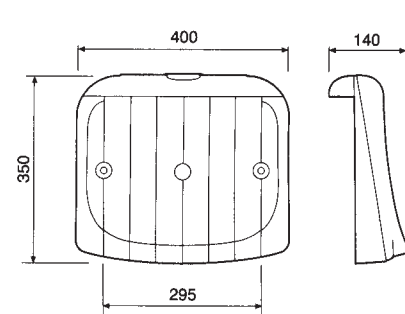

**Art. M90/M90.A**

**Art. M90** Seduta in polipropilene senza schienale ignifuga e antiultravioletti fissaggio diretto sulla gradinata con tasselli (non inclusi)

Polypropylene Seat non ignitable and anti-ultraviolet rays, without back rest - to be fixed with screws (not included)

**Art. M90.A** Seduta in polipropilene senza schienale come Art. M90 solo antiultravioletti fissaggio diretto sulla gradinata con tasselli (non inclusi)

Polypropylene Seat as Art. M90 anti-ultraviolet rays, without back rest - to be fixed with screws (not included)

pg.32

## TRIBUNE - Stands

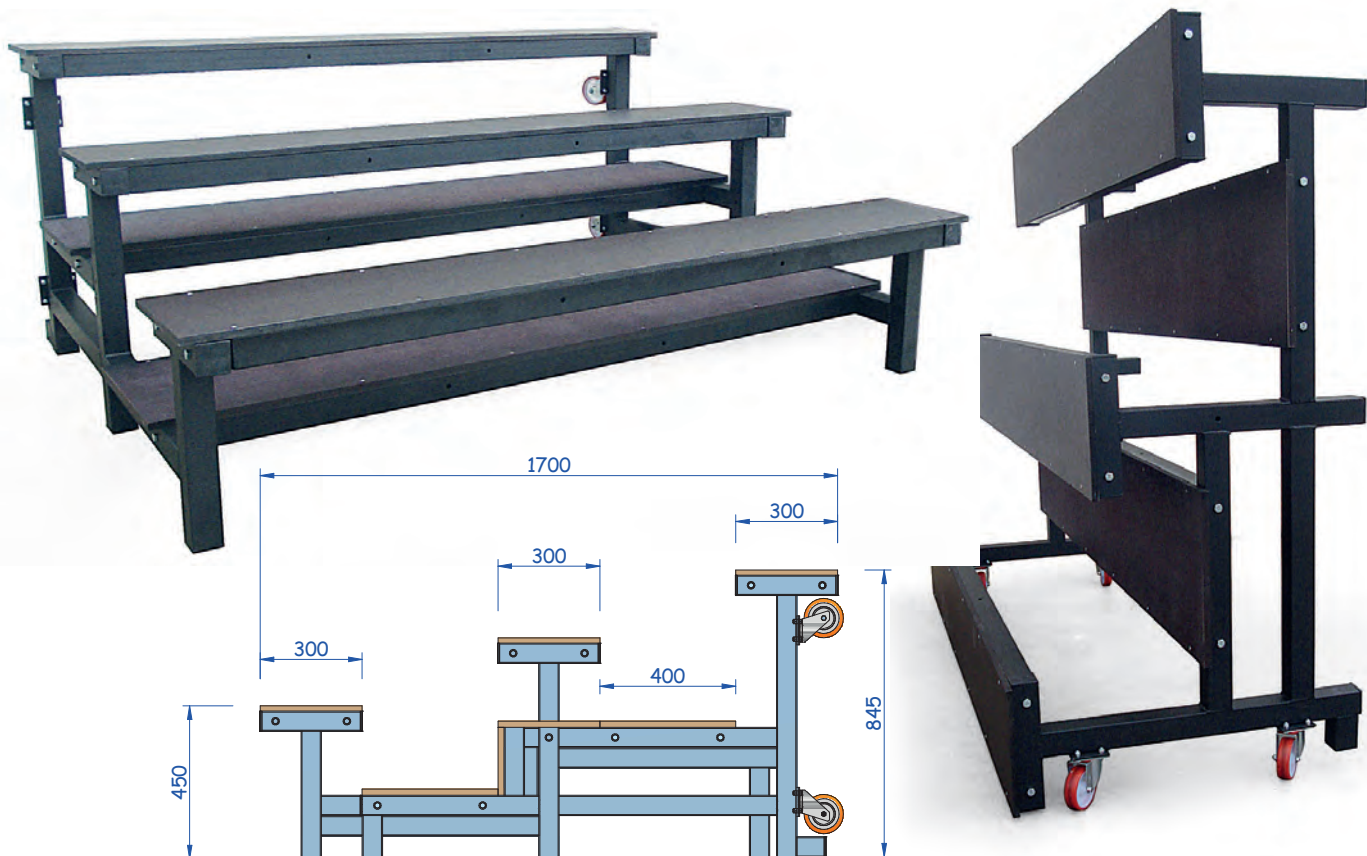

**Art. G12005**

**Modulo Tribuna per interno/esterno su 3 file in acciaio zincato trasportabile su ruote, piani di seduta in carply, lunghezza m. 2,5**

Indoor/outdoor Stand in galvanized steel, 3 rows, movable on wheels, with wooden benches

pg.33



**Art. G12006**

**Modulo Tribuna per interno/esterno su 3 file in acciaio zincato trasportabile su ruote, piani di seduta con scocche in polipropilene, lunghezza m. 2,5**

Indoor/outdoor Stand in galvanized steel, 3 rows, movable on wheels, with polypropylene seats

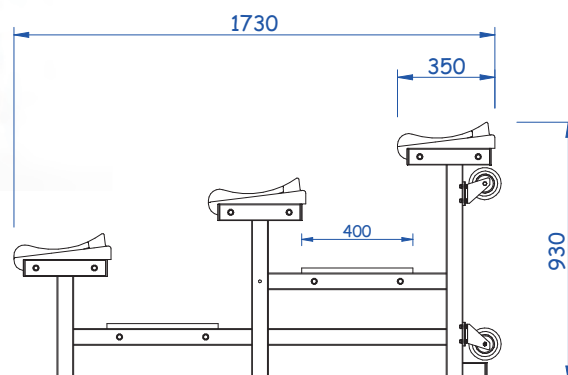



**Art. G120TM**  
**Tribuna telescopica da interno  
con sedute in polipropilene**  
Telescopic Stand for indoor  
with polypropylene seats

pg.33



**Art. S07700**  
**Transenna in  
acciaio zincato**  
**cm. 200x100h.**  
Galvanized steel barrier 200x100 cm.



pg.33

**Art. S07710**  
**Transenna in plastica cm. 215x90h. con piedi di appoggio  
a terra ruotabili, con banda catarifrangente e sistema di  
aggancio a catena**  
Plastic barrier 215x90 cm.

## ARREDI PER SPOGLIATOIO - Dressing Room Benches



**Art. S07326 / S07324**  
Tavola appendiabiti  
con grucce m.1 / m.2  
Clothes hanger board m.1 / m.2

**Art. S07322 / S07320**  
Tavola appendiabiti con tettuccio lunghezza m.1 / m.2  
Clothes hanger board with bag holder m.1 / m.2

**Art. S902.1E / S902.2E**  
Panca in acciaio verniciato  
con listoni in legno m.1 / m.2  
con schienale e appendiabiti  
Bench in painted steel and  
wood length m.1 / m.2  
with back rest and clothes hanger board



**Art. S07308 / S07306**  
Panca in acciaio verniciato  
con listoni in legno  
m.1 / m.2 con schienale  
Bench in painted steel and  
wood length m.1 / m.2  
with back rest

**Art. S07304 / S07302**  
Panca in acciaio verniciato  
con listoni in legno m.1 / m.2  
Bench in painted steel and  
wood length m.1 / m.2

pg.33



**Art. S07406 / S07404**  
Pedana poggiapiedi a listoni  
in legno lunghezza m.1 / m.2  
Footrest in wood length m.1 / m.2

**Art. S07312 / S07310**  
Panca con schienale, appendiabiti e  
portaborse in acciaio verniciato  
con listoni in legno  
lunghezza m.1 / m.2  
Complete Bench  
in painted steel and  
wood length m.1 / m.2

Disponibile  
anche lunghezza  
m. 1,5  
(al prezzo della  
lunghezza m. 2)  
Also available  
length 1,5 m.  
(at the same price  
as length 2 m.)



**Art. S07313/S07314**  
Panca completa  
ad isola per centro  
locale m.1 / m.2  
in acciaio verniciato  
con listoni in legno  
Double bench  
in painted steel and  
wood length  
m.1 / m.2

Colore standard del telaio in acciaio: rosso. Per colore  
argento oppure giallo supplemento del 5% e, in caso di  
quantità inferiore a 10 pezzi, contributo di € 150,00  
per costi di cambio colore. Altri colori su preventivo  
Standard color of the steel frame: red. For silver or yellow  
color 5% surcharge and, if quantity is less than 10 pieces,  
contribution of € 150,00 for color change costs.  
Other colors on quote



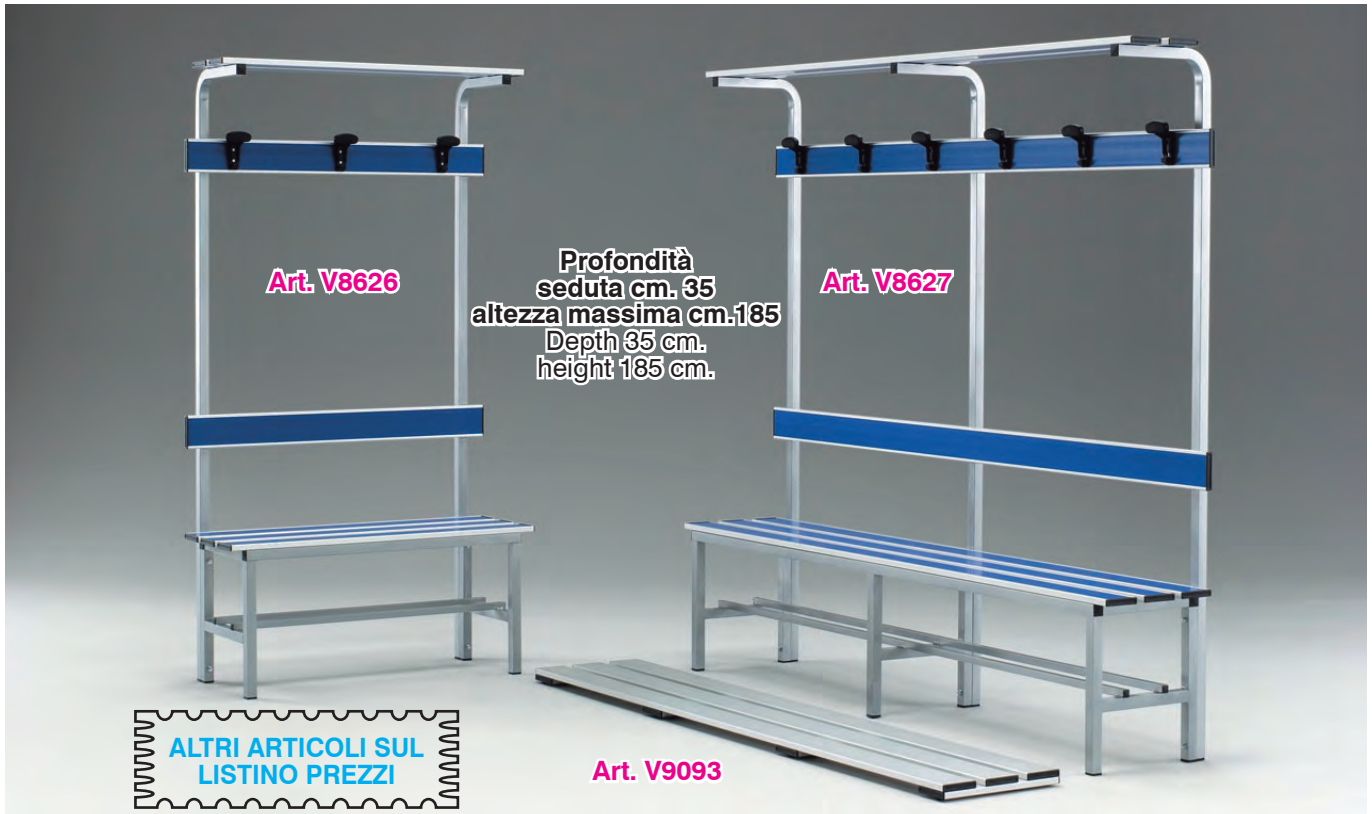

**Art. V8626**

Profondità  
seduta cm. 35  
altezza massima cm.185  
Depth 35 cm.  
height 185 cm.

**Art. V8627**

**ALTRI ARTICOLI SUL  
LISTINO PREZZI**

**Art. V9093**

pg.34

**Art. V8626 / V8627**

Panca con schienale, appendiabiti e portaborse in alluminio anodizzato con inserti in PVC lunghezza m. 1 oppure lunghezza m. 2  
Complete Bench in anodized aluminium length m. 1 or length m. 2

**Art. V9092 / V9093**

Pedana poggia piedi in alluminio anodizzato lunghezza m. 1 oppure lunghezza m. 2  
Footrest in anodized aluminium length 1 or 2 meters

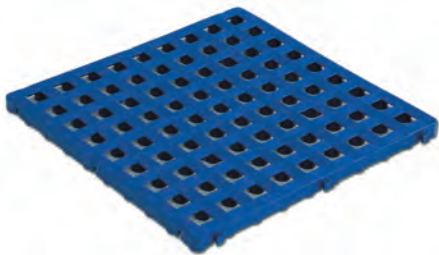

**Art. S07408**

Pedana poggia piedi in plastica cm. 50x50  
Plastic footrest 50x50 cm.



**Art. S07434**

Graticcio per doccia in legno cm. 60x60  
Wooden footrest 60x60 cm.



**Art. S07466**

Asciugacapelli elettrico con temporizzatore e tubo flessibile  
Hair dryer with timer and flexible pipe



**Art. S07458**

Asciugamani elettrico con temporizzatore  
Hand dryer with timer



**Art. TPD** Poggia piedi Footsy idrorepellente  
Foldable foot rest waterproof

**ALTRI ARTICOLI SUL  
LISTINO PREZZI**



**Art. S07462**

Asciugacapelli elettrico con temporizzatore  
Hair dryer with timer

## ARMADIETTI PER SPOGLIATOIO - Dressing Room Lockers



**Art. S07226**  
Armadio casellario a 15 posti in lamiera verniciata - dim. vano cm. 35Lx35px35h  
dimensioni totali cm. 103Lx35px180h  
15 boxes sheet metal filing cabinet

pg.35



**Art. MAP30**  
Armadio portavalori a 30 sportelli  
dim. cm. 95Lx20px50h con serrature  
Safe-deposit locker with 30 boxes

**Art. MAP50**  
Armadio portavalori a 50 sportelli  
dim. cm. 95Lx20px82h con serrature  
Safe-deposit locker with 50 boxes



**Art. S07252 / S07254 / S07256**  
Armadio spogliatoio in laminato  
dim. vano cm.30Lx50px90h  
1 colonna 2 vani  
2 colonne 4 vani  
3 colonne 6 vani  
Laminated Lockers

**Art. S07258 / S07260 / S07262**  
Armadio spogliatoio in laminato  
dim. vano cm.30Lx50px180h  
1 colonna 1 vano  
2 colonne 2 vani  
3 colonne 3 vani  
Laminated Lockers

## ACCESSORI PER SPOGLIATOIO ED INFERMERIA Dressing room and infirmary accessories



**Art. S07448**  
Specchio a parete  
con cornice in plastica  
diametro cm. 50  
Wall mirror with frame  
diameter 50 cm.

**Art. S07438**  
Distributore di sapone  
liquido a parete  
Wall soap dispenser



**Art. S07442**  
Distributore di salviette a parete  
Wall towel dispenser

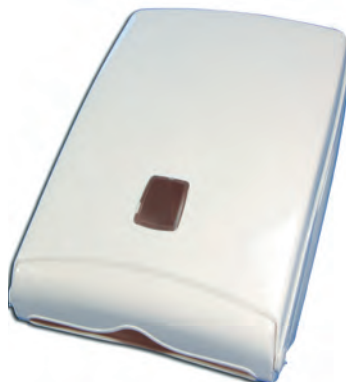

ALTRI ARTICOLI SUL  
LISTINO PREZZI



**Art. S07412**  
Tavolo per  
spogliatoio e  
locale arbitri  
cm. 80x80x76  
Locker room  
table  
80x80x76 cm.

pg.34



**Art. S07416** Bacheca  
con struttura in alluminio cm. 120x90  
Bulletin Board 120x90 cm.

**Art. S07414**  
Sedia in acciaio cromato  
scocca in polipropilene  
Chromed steel chair  
with polypropylene seat



**Art. S07418**  
Portaombrelli a 24 posti  
in acciaio verniciato  
Steel umbrella stand



**Art. S07715** Spazzolone  
per pulizia e asciugatura  
area pubblica e campo di gioco  
Scrubber for cleaning playcourt



**Art. S07102 / S07104**  
**Armadio a vetri a una o due ante**  
 Glass Cabinet with one or two doors



**Art. S07106** **Paravento a tre ante**  
**struttura in acciaio cromato**  
 Three shutter foldable screen



**Art. S07138**  
**Cassetta medica**  
**da fissare a parete**  
**secondo D.M. 388**  
 First aid kit



**Art. S07136**  
**Cassetta medica**  
**portatile**  
**secondo D.M. 388**  
 First aid kit

ALTRI ARTICOLI SUL  
 LISTINO PREZZI

● pg.34 ● pg.35



**Art. S07128**  
**Scaletta scendiletto**  
**in acciaio cromato**  
 Bedside step



**Art. S07124**  
**Sgabello girevole**  
**in alluminio**  
 Turnable stool



**Art. S07108**  
**Appendiabiti a colonna**  
**in acciaio cromato**  
 Clothes stand



**Art. S07132**  
**Cestino in plastica**  
 Plastic trashcan



**Art. S07130**  
**Portarifiuti**  
**a pedale**  
**in acciaio**  
**verniciato**  
 Metal trashcan



**Art. S07134**  
**Portantina pieghevole**  
**in acciaio cromato**  
 Foldable Stretcher in  
 chromed steel

**Art. S07110**  
**Scrivania con cassetiera**  
 dim. cm.130x76x78  
 Desk with 3 drawers dimensions 130x76x78 cm.



**Art. S07114**  
**Sedia imbottita in acciaio cromato** Chair in chromed steel



**Art. S07410**  
**Tavolo per massaggi in acciaio imbottito in similpelle**  
 Massage table



**Art. PTI.BIL**  
**Bilancia pesapersona digitale con indicazione massa grassa**  
 Digital scales body fat measurer

● pg.34

● pg.35



**Art. 3031S**  
**Lettino Antero chiudibile testiera regolabile**  
 cm.180x60x73  
 peso Kg.20  
 colore nero  
 in acciaio cromato  
 Medical couch foldable in chromed steel

**Art. 3033S**  
**Borsone porta lettino Antero**  
 Bag for Art. 3031S

**Art. S07118**  
**Portarotolo**  
 Paper roll holder

**Art. S07120**  
**Rotolo carta**  
 Paper roll



**Art. S07116**  
**Lettino visita medica imbottito con testiera reclinabile**  
 Medical couch in chromed steel, padded, adjustable headrest

## TUNNEL USCITA SPOGLIATOI - Stadium tunnels



**Art. 160 Tunnel estensibile struttura in lega d'alluminio, copertura in PVC ignifugo Cl.2 bianco o colorato, montato su ruote in nylon o pneumatiche, dimensioni standard (personalizzabili): larghezza cm.200, altezza al centro cm.232, altezza ai lati cm.200, in moduli da un metro**  
Extensible Tunnel in light alloy covered by fireproof PVC Cl.2, white or coloured, movable on nylon or pneumatic wheels - Standard dimensions 200 cm. width, 232 cm. height in the middle, 200 cm. height at the sides - made of one meter segments joined together



pg.32



**Lunghezza, larghezza  
e altezza  
personalizzabili su richiesta**  
Any dimension available  
on request



## BEACH SOCCER



### Art. PBSFS

**Coppia Porte Beach Soccer m. 5,5x2,2 in lega d'alluminio tubo sezione mm. 80 verniciate in giallo con bussole a croce**  
Pair of Beach Soccer goals in aluminium 5,5x2,2 m. - pipe 80 mm. painted yellow with sockets

**Art. PBSTR Coppia Porte Beach Soccer m. 5,5x2,2 in lega d'alluminio tubo sezione mm. 80 verniciate in giallo trasportabili**

Pair of Beach Soccer goals in aluminium 5,5x2,2 m. pipe 80 mm. painted yellow transportable

### Art. 110BS

**Coppia Porte Beach Soccer m. 5,5x2,2 in lega d'alluminio tubo sezione mm. 120x100 verniciate in giallo con estensione dei pali da insabbiare (senza bussole)**  
Pair of Beach Soccer goals in aluminium 5,5x2,2 m. - pipe 120x100 mm. painted yellow with extension of posts (with no sockets)

Bussola  
Socket



### Art. 073BS

**Kit 10 paletti completi per Beach Soccer (6 bandierine rosse e 4 bandierine gialle)**  
Kit of 10 Beach Soccer Poles (6 red flags and 4 yellow flags)



**Art. RBS Coppia reti per porte Beach Soccer m. 5,5x2,2 in polipropilene**  
Pair of polypropylene nets for Beach Soccer goals 5,5x2,2 m.



**Art. KDBS Kit Delimitazione per campo Beach Soccer, colore royal: 2 nastri m. 28 + 2 nastri m. 37 larghezza mm. 80 + 8 picchetti e 8 elastici**  
Kit for Beach Soccer bounds



**Art. ULT45 Pallone Beach Soccer Trial in gomma doppio strato (fino ad esaurimento scorte)**  
Trial Beach Soccer Ball double stratum rubber (until available in stock)

## TAVOLI CALCETTO - Soccer tables



### Art. F3FOLDY

Tavolo calcetto in acero  
dim. cm.137x92x81h Kg.26  
aste telescopiche e gambe ripiegabili  
ideale per bambini  
Soccer table for children



### Art. JKBOM

Tavolo calcetto Bomber  
senza gettoniera  
aste telescopiche,  
piano in vetro temperato  
colore blu o bianco  
Soccer table Bomber



pg.45



### Art. IS432

Confezione 10 palline per  
tavolo calcetto  
10 Soccer table balls

### Art. G500

Tavolo calcetto da esterno  
G500 Weatherproof  
con aste telescopiche  
Soccer table G500 for outdoor

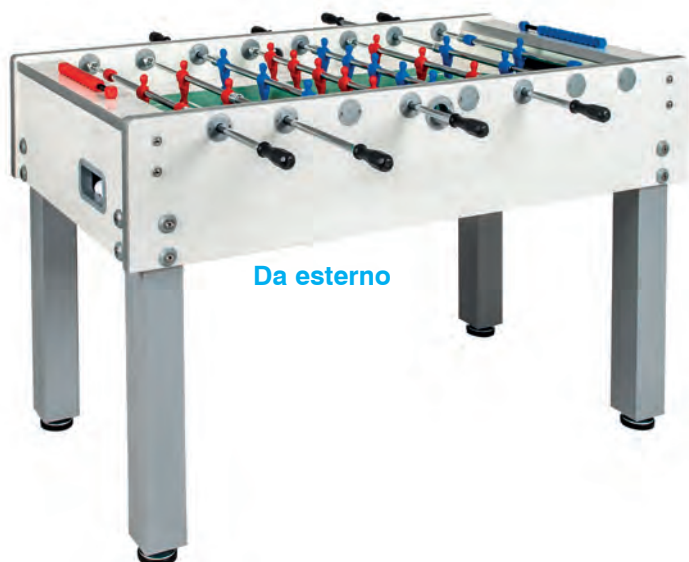

Da esterno

### Art. FTGO.G

Tavolo calcetto modello Pride  
con gettoniera, aste cromate telescopiche,  
gambe in ferro verniciato,  
mobile in multistrato, peso Kg. 73  
Soccer table model Pride with coin slot  
telescopic, legs in painted steel, weight 73 Kg.



### Art. FTEC

Tavolo calcetto modello Pride  
**con vetro protettivo**  
ad alta resistenza, peso Kg. 85  
Soccer table model Pride with high resistance  
safety glass, weight 85 Kg.



## BASKET



**Art. 0873**

**Impianto basket monotubolare zincato con sbalzo mt. 2,20 completo di tabelloni in resina melaminica, canestri e retine**  
Basketball monotubular system galvanized with boards for outdoor

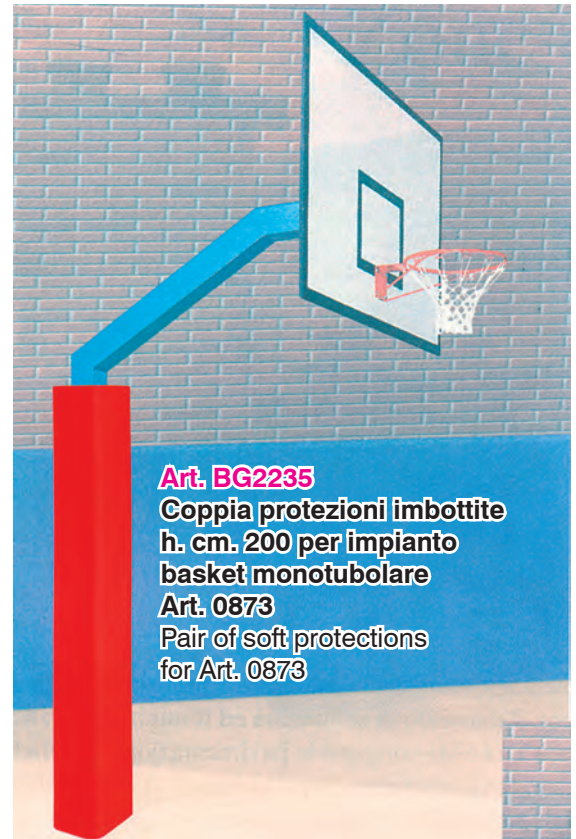

**Art. BG2235**

**Coppia protezioni imbottite h. cm. 200 per impianto basket monotubolare Art. 0873**  
Pair of soft protections for Art. 0873



**Art. V4248**  
**Impianto basket monotubolare trasportabile tabelloni in legno sbalzo cm.165 canestri e retine**  
Monotubular transportable basketball system

**Art. V4500**  
**Impianto basket come Art. V4248 zincato con tabelloni in resina melaminica**  
Monotubular transportable galvanized basketball system boards in resin for outdoor

**Art. V4267**  
**Set protezioni con pannello in legno rivestito in PE spessore mm. 20**  
Pair of soft protections for Art. V4248/Art. V4500

pg.35



**Art. B2084**

**Coppia protezioni imbottite per impianto basket a traliccio dim. cm.200x130**  
Pair of soft protections for basketball system dimensions 200x130 cm.



**Art. S04056 / S04058**

**Impianto basket a muro fisso con sbalzo cm. 185 oppure cm. 325, tabelloni in bilaminato, canestri e retine**  
Wall basketball system projection 185 cm. or 325 cm. wooden boards, rings and nets



**Art. S04151**

**Impianto minibasket a muro fisso, sbalzo cm. 80, tabelloni in bilaminato canestri e retine**  
Wall mini-basketball system projection 80 cm.



**Art. S04152**

**Impianto minibasket a muro fisso, sbalzo cm. 185 tabelloni in bilaminato canestri e retine**  
Wall mini-basketball system projection 185 cm.



**Art. S04150**

**Impianto basket/minibasket a muro regolabile in altezza tabelloni in polipropilene con canestri e retine**  
Wall basketball/mini-basketball system adjustable height



**Art. S04161**

**Art. S04162**

**Art. S04161**

**Coppia strutture minibasket agganciabili a tabelloni basket complete di tabelloni in bilaminato, canestri e retine (carrello per sollevamento strutture Art. S04162 non incluso)**

Pair of mini-basketball constructions to be attached to basketball boards (lifting trolley Art. S04162 not included)



**Art. 647B** Minibasket a colonna regolabile in altezza da cm. 168 a cm. 229 trasportabile con canestro e retina tabellone cm. 90x60  
Minibasket adjustable height from 168 cm. to 229 cm. transportable



**Art. 26759** Basket a colonna regolabile in altezza da cm. 229 a cm. 305 trasportabile con canestro e retina tabellone cm. 120x70 rinforzato  
Basket adjustable height from 229 cm. to 305 cm. transportable



**Art. 26760** Tabellone minibasket in plastica da fissare al muro, fornito con canestro e retina  
Wall minibasket board



**Art. S04012** Struttura basket e minibasket richiudibile e trasportabile in acciaio verniciato, base porta zavorra, tabellone in resina, canestro fisso e retina, protezione frontale  
Transportable and foldable Basket/Minibasket in painted steel, resin board, front protection

pg.35

pg.36



**Art. F126BSK** Set Baskin trasportabile altezza regolabile fino a cm. 220 tabellone cm. 110x73 base zavorrabile su ruote  
Transportable Baskin adjustable height until 220 cm.



**Art. F102**  
**Canestro Basket regolamentare**  
 (retina esclusa)  
 Basket standard



**Art. F103**  
**Canestro Basket rinforzato**  
 (retina esclusa)  
 Basket reinforced



**Art. F105**  
**Canestro Basket zincato**  
 (retina esclusa)  
 Basket galvanized



**Art. B030**  
**Coppia Retine in nylon**  
 mm. 3,5  
 Pair of nets 3,5 mm.



**Art. B050**  
**Coppia Retine in nylon**  
 mm. 6  
 Pair of nets 6 mm.



**Art. B060**  
**Coppia Retine in**  
**cotone mm. 7**  
 Pair of nets 7 mm.



**Art. R122**  
**Coppia Retine in acciaio**  
 Pair of steel nets



**Art. F106**  
**Canestro Basket reclinabile, a norme FIBA**  
 (retina esclusa)  
 Reclining Basket

pg.36

**Art. NRGC**  
**Set 12 ganci reggirete in**  
**plastica per canestro basket**  
 Set 12 plastic basket net holders

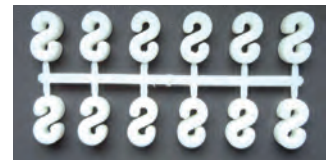

**Art. S04202 - S04214 - S04204 - F116/B - S04216**  
**Coppia tabelloni in bilaminato per interno oppure in**  
**resina melaminica per esterno - varie dimensioni**  
 Pair of basketball boards in chipboard for indoor  
 or in resin for outdoor - various sizes

**Brevettato**  
**Patented**

**Art. F109**  
**Canestro Basket**  
**reclinabile**  
**frontalmente**  
**e lateralmente**  
 (retina esclusa)  
 Front/Side  
 reclining Basket

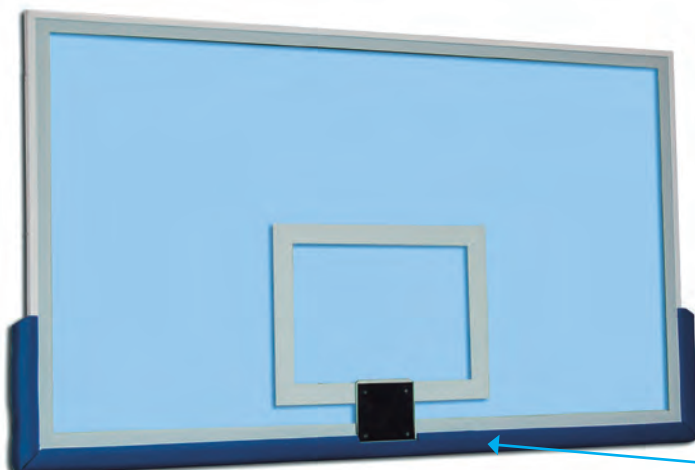

**Art. S04206 / S04208**  
**Coppia tabelloni in Plexiglass trasparente**  
**oppure in cristallo temperato dimensioni**  
**cm. 180x105 - compreso telaio e protezione**  
 Pair of basketball boards in trasparent acrylic  
 or tempered glass 180x105 cm.  
 mounted onto varnished steel frame with pads

**Art. B2063B / B2063**  
**Coppia Protezioni sottocanestro omologate FIBA e non**  
 Pair of soft board protection pads FIBA approved or not



**Art. S04254**  
**Panca per atleti e riserve con schienale m.3**  
 Bench length 3 meter with back rest

**Art. S04266**  
**Protezione mobile per tavolo giuria e atleti in policarbonato trasparente**  
 Transparent movable polycarbonate protection for benches and referees' table



**Art. S04256**  
**Tavolo giuria cm. 160x80x76h.**  
 Referee table

pg.36

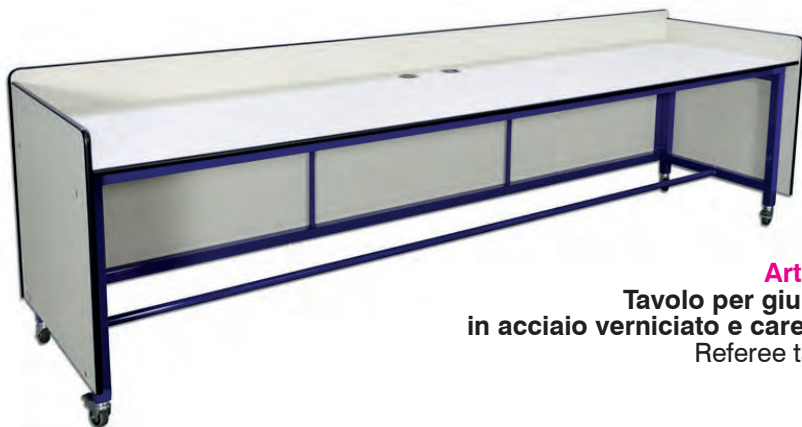

**Art. S04260**  
**Tavolo per giuria cm. 300x70x76h. in acciaio verniciato e carenatura in legno, mobile su ruote**  
 Referee table on wheels



**Art. S04288**  
**Freccia indicatrice possesso palla**  
 Ball possession arrow



**Art. F255**  
**Freccia indicatrice elettronica possesso palla**  
 Electronic ball possession indicator



**Art. F254**  
**Segnalatore time out con impugnatura**  
 Time out indicator



**Art. CR016**  
**Cronometro contasecondi da tavolo a pila con display digitale**  
 Digital Table Clock for basketball



**Art. CR005**  
**Cronometro contasecondi da tavolo a pila con lancette**  
 Table Clock for basketball



**Art. S04280**  
**Segnapunti manuale girevole a 6 cifre**  
 6 figure  
 Scoreboard



**Art. B01084**  
**Segnapunti da tavolo per Basket**  
 Table scoreboard



**Art. S04274**  
**Serie Palette 24"**  
 Set of 24 sec indicators



**Art. S04272**  
**Serie palette per giudici**  
 Set of referee's foul indicators



**Art. S04282**  
**Segnapunti manuale a parete a 6 cifre, struttura in acciaio verniciato**  
 Wall steel 6 figure scoreboard

pg.36 pg.37

**Art. 089-B**  
**Lavagna Basket cancellabile cm. 40x23**  
 Basket Tactical Board erasable 40x23 cm.

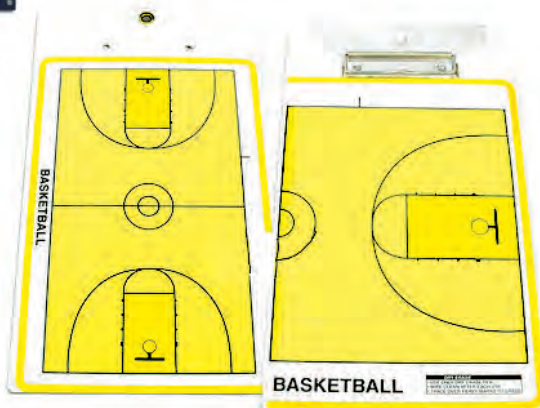

**Art. 087-B**  
**Lavagna Basket magnetica cancellabile cm. 60x85**  
 Basket Tactical Board erasable and magnetic 60x85 cm.



**Art. LSRK**  
**Lavagna Basket magnetica cm. 40x23 con block-notes (fino ad esaurimento)**  
 Basket Tactical Board magnetic 40x23 cm. with block-notes (until available)

**SKLZ** >>



**Art. SK.CVS**  
**COURT VISION**

Occhiali a visibilità limitata per allenamento al palleggio a testa alta, alla visione di gioco e alla reattività nei confronti dei difensori  
misura unica regolabile  
Court vision dribble goggles force players to handle the ball with their head up to survey the court improve reaction time against defenders increase confidence on the court

**SKLZ** >>



**Art. SK.KOT**  
**KICK-OUT per ritorno palla dopo tiro a canestro, direzione regolabile**  
360° ball return system  
rotating chute returns made shots anywhere on the court  
easy twist adjustment with integrated handle



La fascia con le braccia gonfiate deve essere posizionata all'altezza delle spalle e, per installarla, può essere necessario sgonfiare moderatamente la sagoma. Successivamente, dopo avere rigonfiato, se la sagoma torna in posizione verticale con difficoltà si deve aggiungere dell'acqua nel serbatoio

pg.37

**Art. KBVS**  
**Kit braccia verticali per sagoma gonfiabile cm. 205 Art. SAG205**  
Raised arms kit for inflatable dummy 205 cm. Art. SAG205

**Specifico per il Basket, il kit si installa facilmente sulla sagoma (non inclusa) e rende possibile una moltitudine di esercizi tecnico-tattici**  
Designed for Basket training, this kit is easily installed on the dummy (not included) and makes lots of technical and tactical exercises possible

**SKLZ** >>



**Art. SK.DMAN**  
**Sagoma Basket D-MAN ad altezza regolabile da cm. 198 a cm. 243 con basamento riempibile, munita di puntali per fissaggio anche su terreni naturali**  
Hands-up defensive mannequin ideal for solo practice or team settings portable, lightweight adjustable telescoping pole (from 198 cm. to 243 cm.) Weighted base - including spikes for natural grass anchoring



**Art. SB4Y** Pallone avviamento al Minibasket Molten gomma nylon misura 4 Minibasket introduction ball



**Art. BHAR5 / BHAR7** Pallone Basket e Minibasket gomma nylon misure 5 (blu) - 7 (arancio) Nylon rubber Basket and Minibasket ball

pg.37



**Art. SBPRO5** Pallone Minibasket Mondo SB-PRO size 5 gomma multistrato Multilayer rubber Minibasket Mondo SB-PRO size 5 ball



**Art. B5G1600** Pallone Minibasket Molten B5G1600 gomma nylon (ex BGR5) Nylon rubber Minibasket Molten B5G1600 ball



**Art. SBPRO7** Pallone Basket Mondo SB-PRO size 7 gomma multistrato Multilayer rubber Basket Mondo SB-PRO size 7 ball



**Art. B7G1600/B6G1600** Pallone Basket Molten B7G1600/B6G1600 gomma nylon (ex BGR7/BGR6) Nylon rubber Basket Molten B7G1600/B6G1600 ball



**Art. B7G3800/B6G3800** Pallone Basket Molten B7G3800/B6G3800 pelle sintetica FIBA Approved (ex BGM7X/BGM6X) Leather Basket Molten B7G3800/B6G3800 ball

**Art. B7G4000/BGF6X** Pallone Basket Molten B7G4000/BGF6X pelle sintetica ufficiale FIP Leather Basket Molten B7G4000/BGF6X ball



**Art. B7G4500/B6G4500** Pallone Basket Molten B7G4500/B6G4500 pelle sintetica ufficiale FIP Lega Serie A (ex BGG7X/BGG6X) Leather Basket Molten B7G4500/B6G4500 ball



**Art. TRBB** Pallone reaction ball Trial rimbalzo e traiettorie imprevedibili per Basket Trial Reaction Ball unpredictable rebounds



**Art. ULTES60** Pallone Basket sonoro Goalball gomma Trial Ø cm. 24 gr. 1240 Sound rubber Trial Basket ball Goalball



**Art. ULTS67** Pallone Basket gomma Trial allenamento potenziato Ø cm. 24 gr. 930 (+50%) Rubber Trial Heavier Basket ball



**Art. ULTD67** Pallone Basket gomma Trial allenamento potenziato Ø cm. 24 gr. 1240 (+100%) Rubber Trial Heavier Basket ball



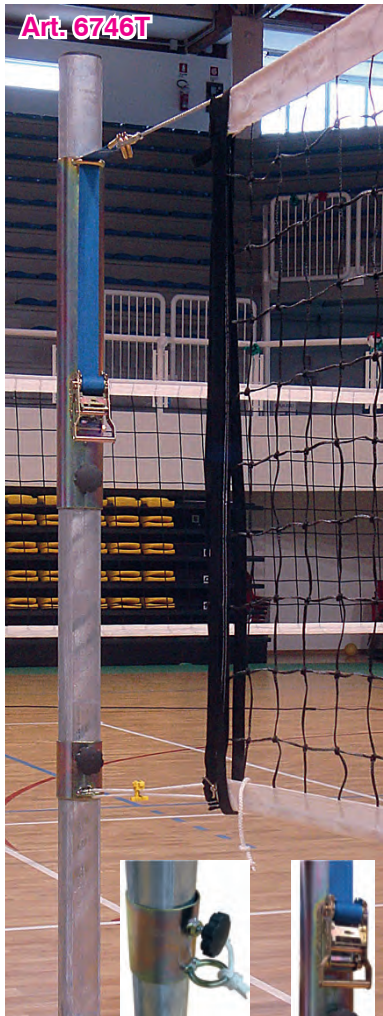

**Art. 6746T**

**PALLAVOLO - Volleyball**

**Art. 6746T**  
 Impianto pallavolo monotubolare in acciaio zincato  $\varnothing$  mm. 76 completo di bussole da interrare cm. 40 e tendirete, altezza della rete regolabile  
 Volleyball posts in galvanized steel with underground sockets adjustable height net

pg.38

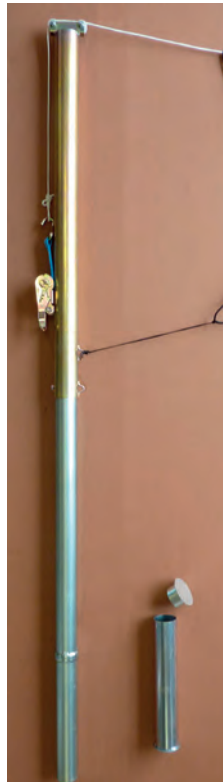

**Art. V5009**

**Art. V5009**  
 Impianto pallavolo monotubolare in alluminio T6 antiflessione mm. 120x100 con arganello tendirete autofrenante e senza cremagliera con manovella asportabile bussole e tappi in alluminio  
 Aluminium monotubular volleyball posts



**Art. ARGC**  
 Arganello a cremagliera con manovella per impianto pallavolo monotubolare  
 Spare rack winch for monotubular volleyball posts

Lato interno  
 Inner side

**Art. V5003**  
 Impianto pallavolo monotubolare in acciaio zincato  $\varnothing$  mm. 70 completo di bussole da interrare e tendirete, con sistema telescopico per la regolazione della rete con doppia carrucola sulla sommità del palo  
 Volleyball posts in galvanized steel with underground sockets telescopic posts adjustable height net

**Art. 6747/P**  
 Impianto pallavolo monotubolare a norme FIPAV in alluminio sezione mm. 120x100 regolazione dell'altezza dei pali e della rete con sistema periscopico con arganello tendirete e bussole incluse  
 Aluminium monotubular volleyball posts periscopic system FIPAV approved



**Art. 6747/P**

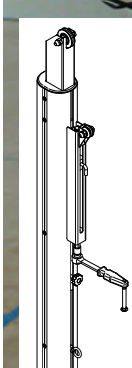

**La regolazione periscopica permette di variare l'altezza dei pali insieme a quella della rete (che può essere regolata da cm. 215 a cm. 243)**

**IMPIANTO = coppia pali (rete esclusa)**

**Art. MB2083** Coppia Protezioni in gommapiuma rivestita per impianto monotubolare  
 Pair of soft protections for volleyball posts



**Art. 1009**  
**Impianto pallavolo a traliccio in alluminio profilo sezione mm. 120x100 completo di ruote e tendirete**  
 Volleyball posts in aluminium transportable with wheels, pipe section 120x100 mm.



**Art. MB2236**  
**Coppia protezioni in gommapiuma rivestita per impianto a traliccio**  
 Pair of soft protections for volleyball posts



Lato interno  
 Inner side



**Art. V5020**  
**Impianto pallavolo a traliccio ø mm. 70 in acciaio zincato completo di ruote e tendirete**  
 Volleyball posts in galvanized steel, transportable with wheels pipe section 70 mm.

**Art. 6740R**  
**Impianto pallavolo a traliccio ø mm. 70 in acciaio verniciato completo di tendirete e ruote**  
 Volleyball posts in painted steel with wheels pipe section 70 mm.



**Art. 6752/T**  
**Impianto Pallavolo a parete**  
 Volleyball posts for wall fixing



**Art. 6752/P**  
**Coppia protezioni per impianto Pallavolo a parete**  
 Pair of soft protections for volleyball posts for wall fixing

pg.38

pg.39

**IMPIANTO = coppia pali (rete esclusa)**

**Art. V5029**  
**Impianto pallavolo a tiranti ridotti in lega di alluminio profilo sezione mm. 120x100 con ruote per il trasporto piastra antitorsione alla base, arganello tendirete autofrenante senza cremagliera antinfortunistico**  
 Volleyball posts in aluminium transportable with wheels, pipe section 120x100 mm.





**Art. E6532**  
**Rete pallavolo economica m. 9,85**  
 Cheap net for volleyball

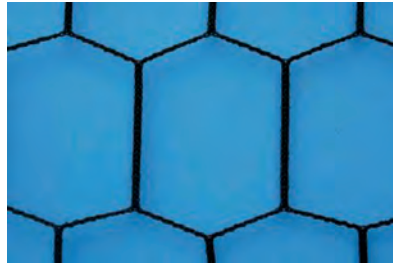

**Art. P030**  
**Rete pallavolo m. 9,50**  
 Net for volleyball

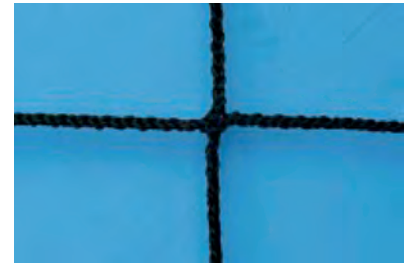

**Art. P100**  
**Rete pallavolo super pesante m. 9,50**  
**maglia mm. 100**  
 Heavy net for volleyball

pg.39



**Art. P110**  
**Rete pallavolo extra pesante**  
**m. 9,50 maglia mm. 100**  
**a doppia fascia**  
 Heavy net for volleyball double band



**Art. P200**  
**Rete pallavolo da gara**  
**maglia mm. 100**  
**con antenne e tasche**  
**a norma FIPAV**  
 Official net for volleyball  
 with sticks and fixing bands



**Art. P201**  
**Rete pallavolo da gara**  
**maglia mm. 45**  
**a norma FIPAV**  
**per campionati di Superlega**  
**(personalizzabile)**  
 Official net for volleyball  
 (customizable)



**Art. P14**  
**Coppia antenne in vetroresina divise**  
 Fiberglass sticks in 2 pieces

**Art. P15** Coppia  
 tasche porta  
 antenne cm. 5  
 Fixing bands for  
 sticks

**Art. P16**  
**Coppia antenne in**  
**vetroresina intere**  
 One piece fiberglass  
 sticks



**Art. S04814**  
**Segnapunti**  
**manuale**  
**girevole**  
**a 4 cifre**  
 4 figure  
 scoreboard



**Art. PP054**  
**Segnapunti manuale**  
**da tavolo per Pallavolo bifacciale**  
**(numeri da 0 a 50 non divisi)**  
 Volleyball table scoreboard



**Art. PPP30**  
**Segnapunti scolastico per Pallavolo**  
**(numeri da 0 a 30 non divisi)**  
 Volleyball school scoreboard



**Art. S04804**  
**Palchetto**  
**arbitro pallavolo**  
**ad altezza fissa**  
**con scocca di**  
**seduta,**  
**in acciaio verniciato,**  
**mobile su ruote**  
 Referee's stand fixed  
 height with plastic  
 seat, made of painted  
 steel, on wheels

**Art. 6768R**  
**Palchetto**  
**arbitro pallavolo**  
**in piedi,**  
**in acciaio verniciato,**  
**mobile su ruote**  
 Referee's stand  
 made of painted steel,  
 on wheels

(pg.39)



**New!**



**Art. S04805**  
**Set protezioni**  
**imbottite per palchetto**  
**Art. S04804**  
 Soft protections for  
 Art. S04804



**Art. V5409**  
**Palchetto arbitro**  
**pallavolo a norma**  
**FIPAV regolabile**  
**in altezza con**  
**scala di accesso**  
**e ruote per trasporto**  
 FIPAV Referee's chair



**New!**

**Art. V5419**  
**Set protezioni**  
**imbottite per palchetto**  
**Art. V5409**  
 Soft protections for  
 Art. V5409



**Art. S04816**  
**Serie 18 Palette per**  
**sostituzione giocatori con**  
**contenitore**  
 Set of 18 substitution indicators



**Art. 089-V**  
**Lavagna per pallavolo**  
**cancellabile cm. 35x25**  
 Volleyball Tactical Board  
 erasable 35x25 cm.



**Art. V5081**  
**Simulatore di muro su ruote in acciaio, zavorrato, con pannello a superficie irregolare**  
 Portable wall in painted steel with irregular surface board

pg.39



**Art. V5082**  
**Simulatore di muro portatile per squadre femminili e giovanili**  
 Portable wall for women and kids



**Art. V5070**  
**Ball Catcher cm. 70x70 altezza regolabile da cm. 190 a cm. 320 con anello superiore inclinabile, basamento zavorrato e rete inclusi**  
 Ball Catcher adjustable height and inclination (weighted base and net included)

**Art. V5051**  
**Jump Tester in acciaio zincato telescopico regolabile da cm. 230 a cm. 380 (basamento zavorrato non incluso)**  
 Jump Tester in galvanized steel telescopic adjustable height from 230 to 380 cm. (weighted base not included)



**Art. V5060** Spike con ganasce (basamento zavorrato non incluso)  
 Spike with jaws (weighted base not included)

**Art. V5050**  
**Basamento zavorrato multiuso per Ball Catcher, Spike, Jump Tester**  
 Multi-purpose weighted base





**Art. BV20**  
**Pallone Volley Trial**  
**in gomma supersoft**  
 Supersoft Trial Volley ball  
 (also for Hit Ball)



Utilizzabile anche  
 per Hit Ball

pg.39 pg.40



**Art. V20**  
**Pallone Volley Trial**  
**in gomma monostrato**  
 Single stratum Trial Volley ball



**Art. ULT20-3**  
**Pallone Volley Trial**  
**in gomma triplo strato**  
 Triple stratum  
 Trial Volley ball

**Art. MVBS**  
**Pallone Volley**  
**School Mondo**  
**Under 13**  
**peso ridotto**  
 Under 13 Mondo  
 Volley School ball

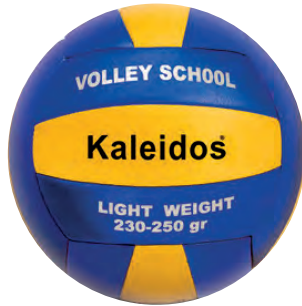

**Art. 18335**  
**Pallone Volley School Molten**  
**V5M2501-L Under 13**  
**peso ridotto**  
 Under 13 Molten  
 Volley School ball



**Art. VS123WL**  
**Pallone Volley School**  
**Mikasa VS123W-L**  
 Under 13 Mikasa  
 Volley School ball

**New!**



**Art. VS123W**  
**Pallone Volley Mikasa**  
**VS123W allenamento**  
 Mikasa Volley  
 training ball



**Art. V300W**  
**Pallone Volley Mikasa**  
**V300W FIVB**  
**approved**  
 Mikasa Volley match ball

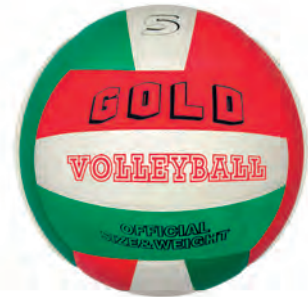

**Art. BT51004**  
**Pallone Volley**  
**regolamentare in PU**  
**allenamento**  
 Official size and  
 weight Volley training ball



**Art. E6835**  
**Pallone Volley**  
**Soft Touch in PU**  
**saldato, regolamentare**  
**allenamento**  
 Official size and  
 weight Volley training ball



**Art. 29096**  
**Pallone Volley Molten**  
**Ultra Touch V5M1500**  
**allenamento**  
 Molten Volley training ball



**Art. 6036**  
**Pallone Volley Molten**  
**V5M4000**  
**allenamento**  
**professionale**  
 Pro Molten Volley  
 training ball



**Art. 6331**  
**Pallone Volley gara**  
**Molten V5M5000**  
**"FLISTATEC" FIVB**  
**Approved**  
 Molten Volley match ball



**Art. TRBV**  
**Pallone Reaction Ball Trial**  
**doppio strato per Volley**  
**rimbalzo e traiettorie**  
**imprevedibili**  
 Trial Volley ball for  
 unpredictable rebounds



**Art. USE20**  
**Pallone Volley Trial**  
 gr. 405 (+50%) ø cm. 21  
 allenamento potenziato  
 Rubber Trial heavy Volley ball



**Art. ULTD20**  
**Pallone Volley Trial**  
 gr. 540 (+100%) ø cm. 21  
 allenamento potenziato  
 Rubber Trial heavy Volley ball

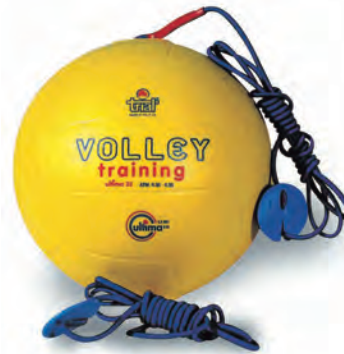

**Art. ULT22**  
**Pallone Volley Trial**  
 con 2 elastici  
 Trial Volley ball with  
 2 elastic ropes

pg.40 pg.41



**Art. P135**  
**Rete MINIVOLLEY su misura a richiesta**  
 Net for minivolley size on request

**Art. P135A**  
**Rete MINIVOLLEY con cavo in acciaio su misura a richiesta**  
 Net for minivolley with steel rope size on request

**Art. P130**  
**Rete MINIVOLLEY**  
 cm.500x70  
 Net for minivolley

**Art. P140**  
**Rete SUPERMINIVOLLEY**  
 cm.650x100  
 Net for superminivolley

**MINIVOLLEY SUPERMINIVOLLEY**

**Art. 6780G**  
**Impianto Minivolley trasportabile su ruote**  
 altezza massima rete cm.200  
 Transportable Minivolley posts adjustable height net (200 cm. maximum height)



**Art. BV15**  
**Pallone PRIMO VOLLEY**  
 Trial in gomma supersoft  
 Trial supersoft Volley ball



**Art. 191S**  
**Pallone MINIVOLLEY**  
 Mondo in gomma  
 Mondo rubber Minivolley ball



**Art. V33**  
**Pallone MINIVOLLEY**  
 Trial in gomma  
 Trial rubber Minivolley ball



**Art. 6332**  
**Pallone MINIVOLLEY**  
 Molten in gomma  
 Molten rubber Minivolley ball



**Art. ULT15-3**  
**Pallone PRIMO VOLLEY**  
 Trial in gomma triplo strato  
 Trial triple stratum Volley ball



pg.39

**Art. 991725/ ... /991728**  
**Kit elastici allenamento pallavolo**  
 soft/medium/hard/extra hard  
 Elastics for volleyball training soft/medium/hard/extra hard



**Art. ULT26-3 / ULT27-3**  
**Pallone MINIVOLLEY/ SUPERMINIVOLLEY**  
 Trial in gomma triplo strato  
 Trial triple stratum Minivolley/ Superminivolley ball



**Art. V27**  
**Pallone SUPERMINIVOLLEY**  
 Trial in gomma  
 Trial rubber Superminivolley ball

## BEACH VOLLEY

**Art. 1051** Impianto Beach Volley regolamentare in alluminio Ø mm. 80 (rete esclusa) altezza rete regolabile anche per Beach Tennis  
Beach volley posts in aluminium (net not included) adjustable height net also for Beach Tennis

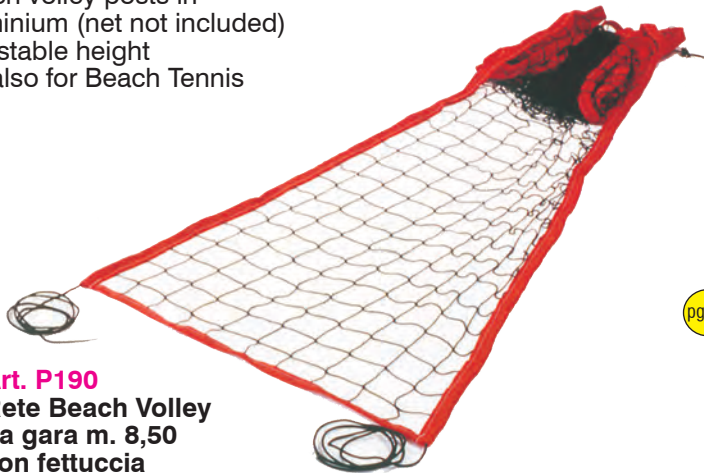

pg.41

**Art. P190** Rete Beach Volley da gara m. 8,50 con fettuccia sull'intero perimetro  
Beach volley match net



**Art. P170** Rete Beach Volley m. 8,50 con fettuccia sul lato superiore  
Beach volley net



Lato A Lato B

**Art. BVMBP** Coppia protezioni per impianto Beach Volley regolamentare altezza cm. 200 diametro cm. 8  
Pair of soft protections for Beach Volley posts



**Art. F501** Impianto Mini Beach Volley portatile con pali telescopici in ferro verniciato completo di rete m. 6,5x1 e sacca  
Mini Beach Volley complete set



**IMPIANTO**  
= coppia pali  
(rete esclusa)

**Art. V5513** Impianto Beach Volley in alluminio Ø mm. 80 (rete esclusa) senza bussole altezza rete regolabile anche per Beach Tennis  
Beach Volley posts in aluminium (net not included) with no sockets adjustable height net also for Beach Tennis



**Art. V5510** Impianto Beach Volley in acciaio zincato Ø mm. 70 (rete esclusa) altezza rete regolabile anche per Beach Tennis  
Beach Volley posts in galvanized steel (net not included) adjustable height net also for Beach Tennis

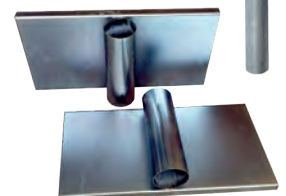





**Art. V5543**

**Seggiolone per arbitro Beach Volley in acciaio ovale verniciato a polveri sez. mm.60 antinfortunistico e richiudibile in soli cm.45**  
Beach Volley referee's Stand

**Art. V5428**

**Protezioni imbottite per seggiolone Art. V5543**  
Soft protections for Art. V5543



**Art. M13719**

**Pallone Beach Volley Mondo BV 2000 in pelle sintetica**  
Mondo Beach Volley ball



● pg.41

**Art. P17**

**Kit Delimitazione campo Beach Volley**  
2 nastri m.16 + 2 nastri m. 8 + 8 picchetti + 8 elastici  
nastri larghezza mm. 50 con occhielli alle estremità  
Set for Beach Volley Bounds

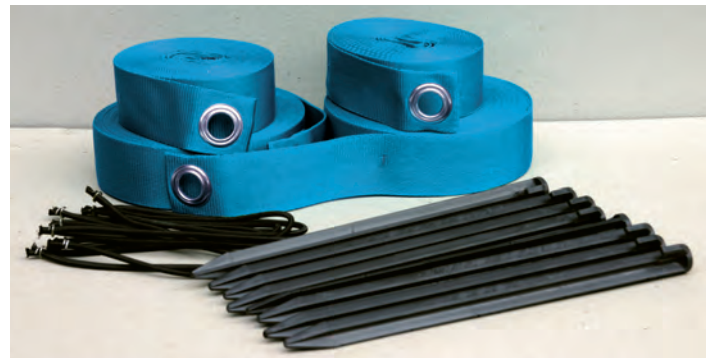

**Art. P19 Kit Delimitazione regolabile per campo Beach Volley e Beach Tennis** - 2 nastri m.16 + 2 nastri m.8 oppure 2 nastri m.18 + 2 nastri m.9 colore royal  
Set for Beach Volley and Beach Tennis adjustable bounds color royal



**Art. 6340**

**Pallone Beach Volley Molten V5B5000 da gara ufficiale FIVB**  
Molten Beach Volley match ball



**Art. 29097**

**Pallone Beach Volley Molten "Sweet Touch"**  
Molten Beach Volley ball

## PROTEZIONI - Protections



**Art. E6644**

**Paio ginocchiere Volley trapuntate misura S, M, L  
colori royal, navy, nero, rosso, fucsia, giallo fluo, verde fluo**  
Pair of knee protections size S, M, L

pg.40



**Art. E6645**

**Paio ginocchiere Volley senza foro  
posteriore con imbottitura modellata  
misura JR e SR, colore royal**  
Pair of knee protections for match size JR and SR

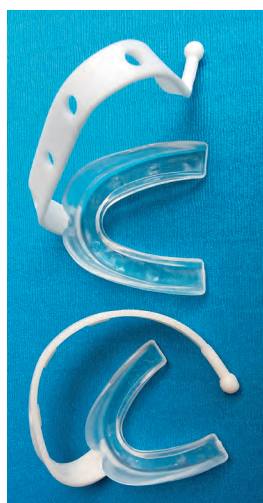

**Art. 9293**

**Paradenti singolo  
taglia adulto**  
Adult Mouthguard

**Art. 9293.B**

**Paradenti singolo  
taglia bambino**  
Junior Mouthguard

**Disponibili  
anche senza  
reggi-paradenti**



**Art. 43602A**

**Paradenti doppio  
taglia S-L**  
Double Mouthguard Size S-L



**Art. E6641**

**Paio ginocchiere Volley professionali  
regolabili con velcro, misura SR colori blu e nero**  
Pair of pro knee protections size SR adjustable with  
velcro - colors blue and black



**Art. PDFOX**

**Paradenti FOX singolo  
taglia adulto - vari colori**  
Adult FOX mouthguard - various colors



**Art. E6642**

**Paio ginocchiere Volley gara misura JR e SR  
colori royal, rosso, bianco e nero  
(fino ad esaurimento scorte)**  
Pair of knee protections for match size JR and SR  
(until available)



pg.40



**Art. ESPN**

**Maschera di  
protezione per  
naso, zigomi  
e arcata  
sopracciliare**  
Face Protection  
Mask



**Art. E6633 Paio gomitiere Volley, misura JR e SR  
colori royal, rosso e nero**  
Pair of elbow protections size JR and SR



Art. E6649

Art. E6650

Art. E6670

**Art. E6649**

**Paio ginocchiere elasticizzate misura S-M-L-XL**

Pair of elastic Knee Protections size S-M-L-XL

**Art. E6650**

**Paio cosciere elasticizzate misura S-M-L-XL**

Pair of elastic Thigh Protections size S-M-L-XL

**Art. E6670**

**Paio cavigliere elasticizzate misura S-M-L-XL**

Pair of elastic Ankle Protections size S-M-L-XL



**Art. IS799**

**Ginocchiera con supporti rigidi taglia S/M - L/XL**  
Knee protection with metal support



**Art. E784**

**Ginocchiera in neoprene traspirante con foro taglia S-M-L**  
Neoprene Knee Protection

pg.40



**Art. E790**

**Cavigliera in neoprene taglia S-M-L**  
Neoprene Ankle Protection

**New!**



**Art. ACISM**

**Arm compress colore nero misura S cm.37 - M cm.40 - L cm.43**  
Arm compress black color



**Art. AHF-075**

**Polsiera stabilizzante in neoprene con foro per il pollice e chiusura regolabile con velcro**  
Stabilizing neoprene cuff with thumb hole and adjustable velcro closure



**Art. E798**

**Supporto Coscia in neoprene taglia S (ad esaurimento)**  
Neoprene Thigh Protection (until available)



**Art. 90252A**

**Fascia sottorotulea in neoprene**  
Neoprene underknee band



**Art. 2651A**

**Short in neoprene vita alta colore nero taglia S-M-L-XL**  
Neoprene Shorts



**Art. 73001**

**Sospensorio con conchiglia misura S, M, L**  
Shell Protection size S, M, L



**Art. AHF-079**

**Pancierina in neoprene taglia unica cm. 120x25x0,4**  
Neoprene stomach band 25 cm. height

## IMPIANTI MULTIFUNZIONE Multi-purpose systems



### Art. S05206

**Impianto multifunzione professionale per volley, minivolley, tennis e salto in alto - basi zavorrate in acciaio zincato su ruote gommata, ritti centimetrati in alluminio verniciato con cursore scorrevole**  
 Volley, Minivolley, Tennis and High Jump transportable system - galvanized weighted bases with wheels, posts in painted aluminium with slider



### Art. S05208

**Coppia tabelloni basket/minibasket in plastica con canestri su supporto in acciaio per Art. S05206**  
 Pair of boards with baskets and steel back frames for Art. S05206



### Art. S05209

**Set protezioni per impianto multifunzione Art. S05206**  
 Soft Protection set for transportable system Art. S05206

**IMPIANTO = coppia pali (rete esclusa)**



pg.43

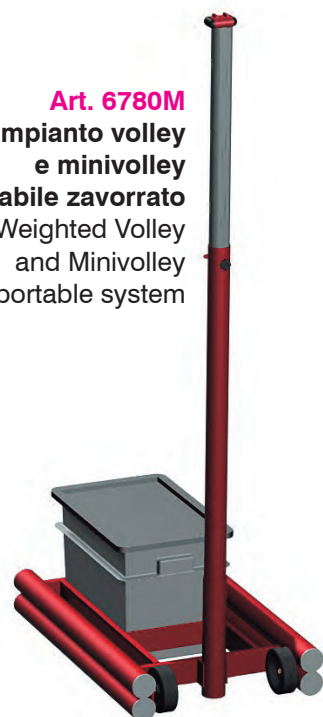

### Art. 6780M

**Impianto volley e minivolley trasportabile zavorrato**  
 Weighted Volley and Minivolley transportable system



### Art. S05210

**Rete per impianti multifunzione Art. S05206/130FA/6780M dimensioni m. 9x1**  
 Net for multi-purpose systems size m. 9x1



### Art. KB130

**Coppia tabelloni basket/minibasket con canestri da applicare ad impianto multifunzione Art. 130FA**  
 Pair of boards with baskets for transportable system Art. 130FA



### Art. 131F

**Set protezioni imbottite sagomate per impianto multifunzione Art. 130FA**  
 Soft protection set for transportable system Art. 130FA

**Art. 130FA**  
**Impianto multifunzione volley, minivolley, badminton, tennis trasportabile zavorrato con strutture verticali in acciaio verniciato metallizzato Ø mm. 80, basi in plastica riempibili da litri 105 con ruote**  
 Volley, minivolley, badminton, tennis transportable system with painted steel poles Ø 80 mm. 105 liter refillable plastic bases with wheels





pg.41

pg.42

## PALLAMANO - Handball

**Art. 7800G**  
Coppia porte pallamano  
in acciaio mm. 80x80  
(reti escluse)  
Pair of steel  
handball Goals

**Art. 7801G**  
Coppia porte pallamano  
in alluminio mm. 80x80  
(reti escluse)  
Pair of aluminium  
handball Goals

Le reti per porte  
pallamano  
corrispondono  
alle reti  
per porte calcetto  
m. 3x2  
Same nets as futsal  
goals 3x2 m.

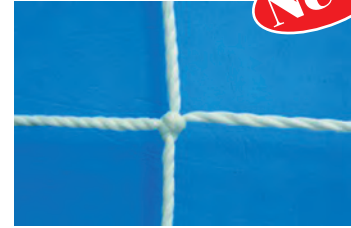

**New!**

**Art. PM113T**  
Coppia reti Pallamano m.3x2  
annodate in nylon text Ø mm.5  
con tenda ammortizzatrice  
Handball nets  
with shock-absorbing curtain



**Art. BA25 / BA0 / BA29 / BA30**  
Pallone Pallamano  
Trial in gomma supersoft  
junior / femminile  
Handball supersoft  
junior / size 2 in rubber



**Art. PTI.HB**  
Lavagna Pallamano  
bifacciale, magnetica  
e cancellabile cm. 35x22  
Handball tactical board



**Art. V29 / V30 / V49 / ULT49-3 / ULT30-3**  
**ULT303.15 / ULT29-3 / ULT24-3**  
Pallone Pallamano Trial in gomma  
mono e triplo strato mis. 0-1-1,5-2-3  
Trial Handball in rubber single and triple stratum  
size 0-1-1,5-2-3

**Special  
Price**



**Art. ULT34 / ULT35 / ULT36-3 / ULT37-3**  
Pallone Beach Handball Trial in gomma triplo strato  
mis. 00, 0, 2, 3  
Trial Beach Handball in rubber size 00, 0, 2, 3

**Art. ULTS29 / ULTD29**  
**ULTS30 / ULTD30**  
**ULTS49 / ULTD49**

Pallone Pallamano  
Trial in gomma  
potenziato  
Ø cm. 15/17/18,5  
gr. 375/500/550/630/  
700/750 (+50% / +100%)  
Rubber Trial Heavier Handball



**Art. SH1**  
Pallone Pallamano Trial Micro/Midi  
Handball per l'apprendimento  
dei fondamentali  
Trial Rubber Micro/Midi Handball  
helps in learning the basics



**Art. TRBH**  
Pallone Reaction Ball Trial  
doppio strato  
rimbalzo e traiettorie  
imprevedibili  
Trial Reaction Ball unpredictable  
rebounds for Handball

## TABELLONI ELETTRONICI BASKET, PALLAVOLO, MULTISPORT Electronic scoreboards for basketball, volleyball, multisport



### Art. F160

Tabellone portatile MULTISPORT da tavolo con tastiera di comando per BASKET, VOLLEY, CALCETTO, PALLANUOTO, PALLAMANO, KICK BOXING, PING PONG ed altro punteggi da 0 a 199 per lato set/bonus/falli da 0 a 9 per lato cronometro massimo 99 minuti e 59 secondi periodi da 0 a 9 - altezza cifre cm.9 dim. cm. 55x35x9,5  
Multisport Table Scoreboard (for BASKET, VOLLEY, FUTSAL, WATER POLO, HANDBALL, KICK BOXING, TABLE TENNIS)

● pg.37

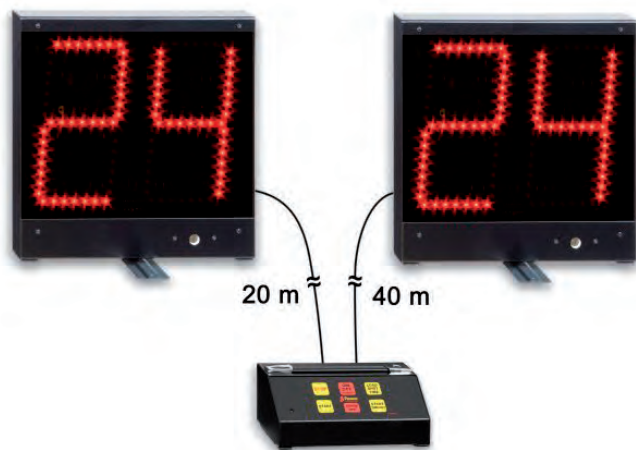

### Art. F270

Kit indicatori elettronici 24 secondi h. cifre cm.20 - dim. cm.29,2x30,4x4,4 cadauno completo di console munita di tastiera visualizzazione del tempo di tiro e del timeout segnalatore acustico di fine tempo, un cavo m.20 e un cavo m.40 in dotazione  
Kit 24 second indicators with console



### Art. F268-02

Kit indicatori elettronici 24-30 secondi wireless h. cifre cm.20 - dim. cm.28,5x32x10 cadauno completo di console Art. F308-01 con valigetta e ricevitore radio, visualizzazione del tempo di tiro segnalatore acustico di fine tempo  
Kit 24 second indicators wireless with console Art. F308-01 (with case) and radio receiver

● pg.38



**Art. F3045015**

Tabellone segnapunti MULTISPORT dimensioni cm.91x60x9,5  
peso Kg.10 - utilizzabile per BASKET, VOLLEY, CALCETTO,  
PALLAMANO, PALLANUOTO, TENNIS, PING PONG, BADMINTON  
altezza cifre cm.15 - visualizzazione di punteggi, cronometro, timeout, falli squadra, periodo, possesso palla  
console Art. F308-01 non inclusa, ricevitore radio incluso  
Electronic Board, dim. 91x60x9,5 cm.  
15 cm. high figures for various sports  
console Art. F308-01 not included, radio receiver included



pg.37

**Art. F308-01**

Console 700 per  
Art. F3045015 e Art. F3045025  
Display touchscreen utilizzabile per  
collegamento sia via cavo che via radio  
dim. cm.24,5x17x8,5  
alimentata da rete o con batteria al litio ricaricabile  
Console for Art. F3045015 and Art. F3045025  
with cable or radio system



**Art. F3045025**

Tabellone segnapunti MULTISPORT omologato FIBA livello 3 utilizzabile per  
BASKET, VOLLEY, CALCETTO, TENNIS, PING PONG, PALLAMANO, PALLANUOTO, BADMINTON  
altezza cifre cm.25 distanza di leggibilità m.110 - peso Kg.22 - dimensioni cm.140x83x9  
da utilizzare con console Art. F308-01 (non inclusa), ricevitore radio incluso  
Electronic Board, dim. 140x83x9 cm. - 25 cm. high figures for various sport  
console Art. F308-01 not included, radio receiver included

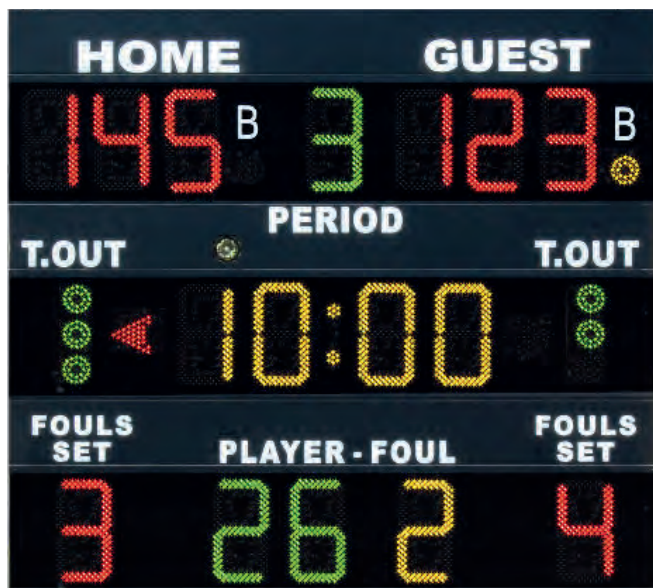

**Art. F242**

**Tabellone MULTISPORT FS-130**  
 dimensioni cm.200x180x9 - peso Kg.60  
 costruito secondo le disposizioni FIBA  
 utilizzabile per BASKET, VOLLEY, CALCETTO,  
 PALLAMANO, HOCKEY, TENNIS, PALLANUOTO  
 altezza cifre cm.30 tempo di gioco 99:59  
 punteggi di squadra (da 0 a 199) - periodo (0 - 9)  
 falli di squadra/set vinti (da 0 a 9) - bonus  
 (1 punto luminoso per squadra)  
 timeout (3 punti luminosi per squadra)  
 possesso/servizio/turno: frecce indicatrici  
 indicazione ultimo fallo avvenuto  
 (numero di maglia del giocatore e numero del fallo)  
 Console Art. F308-01 non inclusa, ricevitore radio  
 Art. F265-20 non incluso

Electronic Board, dim. 200x180x9 cm.  
 30 cm. high figures for various sport  
 Console Art. F308-01 not included,  
 radio receiver Art. F265-20 not included

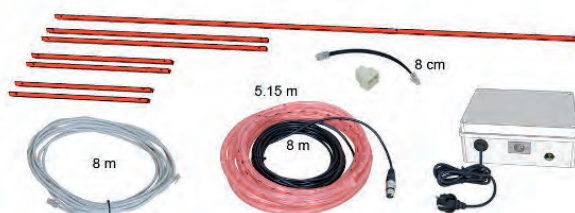
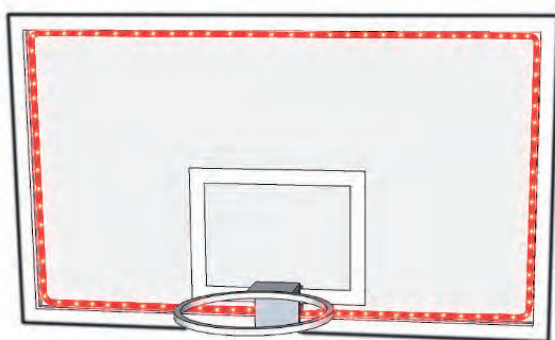

**Art. F253-21**

**Kit cornice luminosa e centralina di comando per tabellone basket Ledstrip cm.515**  
 Kit light frame and control unit for basketball board Ledstrip 515 cm.



**Art. F308-01**

Console 700 per Art. F242  
 Display touchscreen - utilizzabile per collegamento sia via cavo che via radio  
 dim. cm.24,5x17x8,5  
 alimentata da rete  
 o con batteria al litio ricaricabile  
 Console for Art. F242  
 with cable or radio system

pg.38



**Art. F258-51**

**Tabellone elettronico indicatore 24 secondi e tempo di gioco FS-24s-1**  
 dim. cm.70,5x60x11,5 h. cifre cm.14 e cm.30 - da collegare con  
 Art. F253-21, completo di cavo m.50 per collegamento alla console  
 Art. F308-01 - protetto contro gli urti della palla - *N.B. Per un impianto Basket completo occorrono n. 2 Art. F253-21 + n. 2 Art. F258-51*  
 24 second indicator board



**Art. F265-20**

**Ricevitore radio per collegamento del tabellone indicatore 24 secondi**  
 Art. F258-51 alla console Art. F308-01  
*N.B. Per un impianto Basket completo occorrono n. 2 Art. F253-21 + n. 2 Art. F258-51 + n. 2 Art. F265-20*  
 Radio receiver connecting  
 Art. F258-51 to Art. F308-01



**TENNIS**

**Art. 8820G**  
Coppia Pali Tennis in acciaio verniciato a sezione quadra con bussole da interrare e tendirete  
Tennis Posts in painted steel with underground sockets

**Art. 1058**  
Coppia Pali Tennis da fissare al pavimento in acciaio verniciato a sezione quadra e tendirete in bronzo ad arganello  
Tennis Posts in painted steel for ground fixing

**Art. 1056**  
Coppia Pali Tennis in acciaio zincato e verniciato a polvere sezione quadra con bussole da interrare e tendirete in bronzo ad arganello  
Tennis Posts in galvanized and painted steel with underground sockets

**Art. 1056ZA**  
Come Art. 1056 ma verniciato acrilico liquido  
Same as Art. 1056 but painted liquid acrylic

**Art. 1059**  
Coppia Pali Tennis da fissare al pavimento in alluminio e tendirete in bronzo ad arganello  
Tennis Posts in aluminium for ground fixing

pg.42

**Art. 8819G**  
Coppia Pali Tennis in alluminio con bussole da interrare e tendirete  
Tennis Posts in aluminium with underground sockets

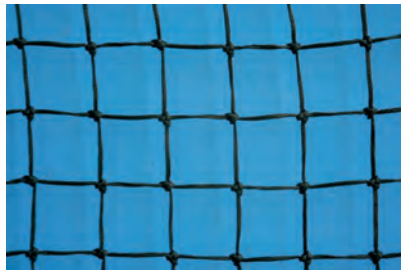

**Art. T030**  
Rete Tennis annodata m.12,80x1 - sp. mm. 2,5 (centro rete non incluso)  
Tennis knotted net (Art. RT1 not included)

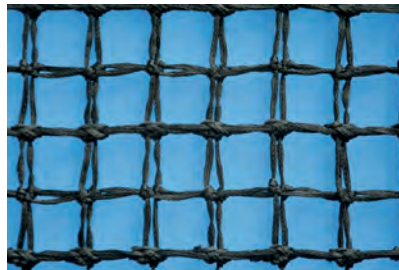

**Art. T050**  
Rete Tennis annodata m.12,80x1 super pesante da gara - spessore mm. 3,5 (centro rete Art. RT1 non incluso)  
Tennis knotted match net (Art. RT1 not included)

**Art. RT1**  
Centro rete  
Net central holder



**Art. G8835**  
Seggiolone verniciato per arbitro  
Painted referee's Chair



**Art. TE10030**  
Impianto Junior Tennis cm. 500x100 in acciaio trasportabile (rete esclusa)  
Transportable junior Tennis posts in steel (net not included)

**Art. TE10031**  
Rete per impianto  
Art. TE10030  
Net for Art. TE10030



**Art. S04862**  
Impianto Tennis in acciaio zincato trasportabile (rete e zavorra escluse)  
Transportable Tennis posts in galvanized steel (net and weights not included)



**Art. S04868**  
Coppia paletti per singolo in acciaio zincato  
Pair of steel poles for single



**Art. RTAD / RTB912 / RTB58**  
**Racchetta Tennis Dunlop in lega**  
**27" (adulti) - 25" (9/12 anni) - 23" (5/8 anni)**  
 Tennis rackets



**Art. AGDP**  
**Tubo 3 palle Tennis**  
**Dunlop**  
**depressurizzate**  
**(rimbalzo ridotto**  
**del 50% per scuole**  
**tennis)**  
 Set 3 depressurized  
 Tennis balls

pg.42

pg.43



**Art. 44.045 Over Grip**



**Art. E6620**  
**Paio Polsini**  
**tergisudore**  
**altezza cm. 7**  
 Pair of  
 Wrist bands



**Art. E6610**  
**Fascia**  
**tergisudore**  
**altezza cm. 5**  
 Headband



**Art. T4D**  
**Tubo 4 Palle Tennis**  
**Head Championship**  
 Set 4 Tennis Balls



**Art. T4DAC**  
**Tubo 4 Palle Tennis**  
**Dunlop Fort All Court**  
 Set 4 Tennis Balls

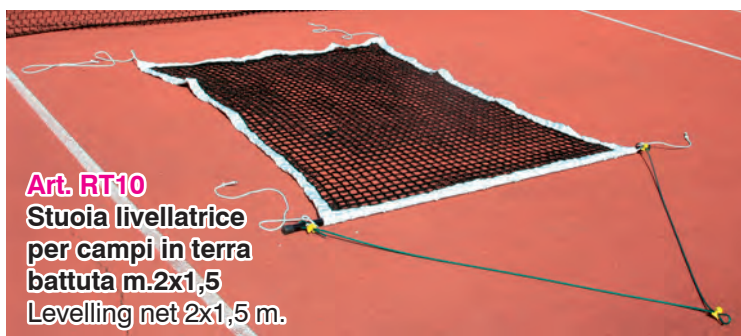

**Art. RT10**  
**Stuoia livellatrice**  
**per campi in terra**  
**battuta m.2x1,5**  
 Levelling net 2x1,5 m.



**Art. 07861 Set 3 palline tennis**  
**in gommapiuma**  
 Set 3 foam rubber tennis balls



**Art. TE220.40 Macchina**  
**lancia palline**  
**velocità max 130 km/h**  
**velocità min 32 km/h**  
**intervalli di lancio**  
**da 2 a 15 secondi**  
 Ball throwing machine



**Art. TE51.04**  
**Rullo in acciaio**  
**con racla**  
 Levelling roller

## BEACH TENNIS - PADEL - PICKLEBALL



**Art. 48018**  
Racchetta Beach Tennis in resina  
(il colore e la grafica possono variare)  
Beach Tennis racket

pg.42 pg.43



**Art. PT41**  
Pallina Beach Tennis  
Beach Tennis ball



**Art. TPAPD**  
Tubo 3 Palle Padel  
Dunlop Team  
(o modello simile)  
Set 3 Padel Balls



**Art. RPDH**  
Racchetta Padel  
XQMAX  
Hurricane/Prox  
(o modello simile)  
Padel Racket



**Art. P210**  
Rete Beach Tennis  
m.8,50x1  
con fettuccia  
sull'intero perimetro  
Beach Tennis net



**Art. T043**  
Rete Padel m.10x0,92  
Padel net



**Art. P121**  
Rete Pickleball m.7x0,9  
Pickleball net

**Art. PBRCK**



**Art. PBRCK** SET 2 RACCHETTE Pickleball, 6 palline, custodia

**Art. PBPLI/  
PBPLO**



**Art. PBPLI** SET 6 PALLINE Pickleball indoor 26 fori

**Art. PBPLO** SET 6 PALLINE Pickleball outdoor 40 fori

**Art. PBSET** SET Pickleball con rete portatile, 4 racchette, 6 palline, set righe campo, custodie



**Art. PBSET**

**New!**

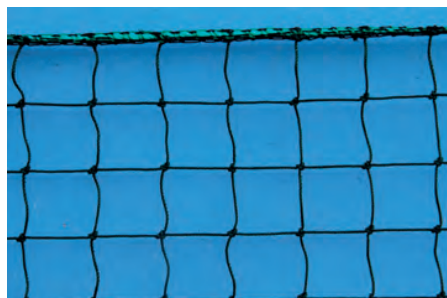

**Art. 0934N**  
Rete protezione  
polietilene verde annodata  
maglia mm. 45x45 sp. mm. 2  
Protection Net green polyethylene  
mesh 45x45 mm.  
knotted, thick 2 mm.



**Art. 40/S - 41/S**  
Telo fondo campo Tennis  
densità 90% o 70% mt.18x2  
con banda di rinforzo  
Tennis perimeter net density  
90% or 70% dim. 18x2 meters

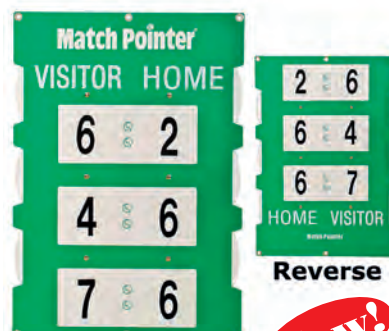

**Art. TE53090**  
Tabellone segnapunti Tennis  
cm. 46x65 h. cifre cm. 8  
completo di agganci  
per la recinzione  
Tennis scoreboard 46x65 cm.

**New!**

## TENNIS TAVOLO - Table Tennis

**Art. BT36302**  
**Racchetta**  
**Ping Pong**  
**Club 3 stelle**  
 3 star  
 table tennis bat



**Art. 83925A**  
**Racchetta**  
**Ping Pong**  
**Dunlop**  
**Evolution 1000**  
 (o modello simile)  
 Dunlop  
 table tennis bat

pg.43 pg.44



**Art. BT35101**  
**Confezione 6 Palline**  
**Ping Pong 3 stelle**  
 Set of 6 table tennis balls  
 3 stars

**Art. 568001**  
**Racchetta Ping Pong**  
**Dunlop Nitro**  
 (o modello simile)  
 Dunlop table tennis bat



**Art. 2C4118C**  
**Confezione 100 Palline**  
**1 stella colore bianco**  
 Set of 100 table tennis balls  
 1 star



**Art. 48441**  
**Confezione 6 Palline**  
**Dunlop Championship**  
**1 stella**  
 Set of 6 table tennis balls  
 1 star



**Art. 17362**  
**Confezione 3 Palline**  
**Stiga 3 stelle Perform**  
 Set of 3 Stiga  
 table tennis  
 balls 3 stars



**Art. PP50**  
**Rete in polietilene**  
 Table Tennis Net



**Art. E5019**  
**Rete Ping Pong**  
**regolabile portatile universale**  
 Table tennis net adjustable length

**Art. 48448**  
**Set rete con paletti**  
 Table Tennis Net  
 with holder



**Art. PPP30**  
**Segnapunti per Ping Pong**  
**(numeri da 0 a 30 non divisi)**  
 Table tennis scoreboard





**Art. C-163I**  
Tennis tavolo  
modello **PROGRESS** da interno  
Indoor Table Tennis PROGRESS

**Art. C-163E**  
Tennis tavolo  
modello **PROGRESS** da esterno  
Outdoor Table Tennis PROGRESS



**Art. C-277I**  
Tennis tavolo  
modello **ADVANCE** da interno  
Indoor Table Tennis ADVANCE

● pg.43



**Tutti i tavoli sono pieghevoli  
e su ruote**  
All models are foldable  
and on wheels



## RUGBY

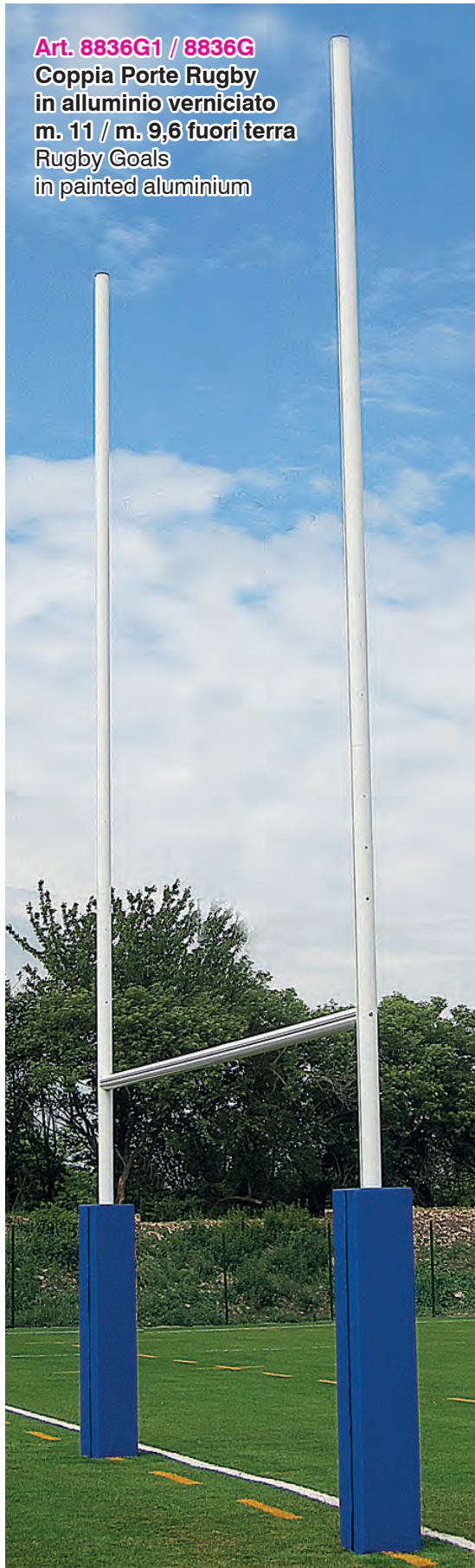

**Art. 8836G1 / 8836G**  
**Coppia Porte Rugby**  
**in alluminio verniciato**  
**m. 11 / m. 9,6 fuori terra**  
**Rugby Goals**  
**in painted aluminium**

**Art. 993156 / 993157 / 993162**  
**Protezione imbottita per palo porta rugby**  
**h. cm. 200, modello**  
**quadrato oppure tondo**  
**Soft Protection for rugby goal post, square**  
**and round shape, height 200 cm.**



**Art. V71**  
**Pallone mini-rugby Trial**  
**in gomma monostrato**  
**gr. 350 dim. cm.15/27**  
**Trial rubber mini-rugby Ball**  
**single stratum**



**Art. ULT71**  
**Pallone mini-rugby Trial**  
**in gomma doppio strato**  
**gr. 350 dim. cm.15/27**  
**Trial rubber mini-rugby Ball**  
**double stratum**

pg.45



**Art. ULT70**  
**Pallone rugby Trial**  
**in gomma doppio strato**  
**gr. 450 dim. cm.19/28**  
**Trial rubber rugby Ball**  
**double stratum**

**Art. W.MVP**  
**Pallone football americano**  
**in pelle sintetica**  
**Wilson MVP ball**



**Art. 993164**  
**Protezione copri bandierina**  
**cm.10x10x100h.**  
**Protection for rugby flag pole**  
**10x10x100h. cm.**

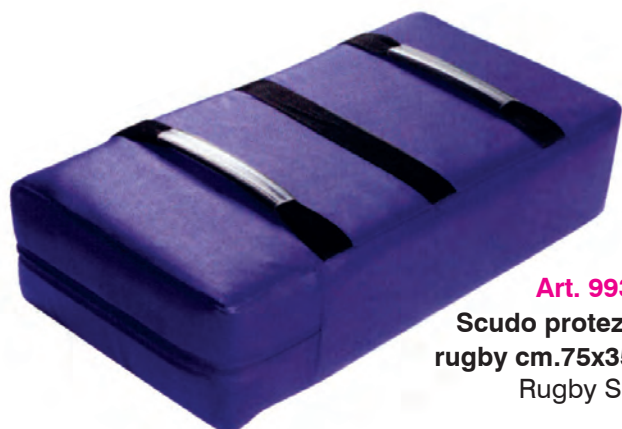

**Art. 993032**  
**Scudo protezione**  
**rugby cm.75x35x15**  
 Rugby Shield



**Art. 6M18**  
**Confezione 100 Tacchetti rugby**  
**mm.18 in alluminio**  
 Rugby aluminium studs  
 18 mm. 100 piece pack

● pg.45



**Art. 993151 / 993153JR**  
**Sacco placcaggio rugby h. cm.140 oppure**  
**cm.120, diametro cm. 45 oppure cm. 35,**  
**con 3 maniglie**  
 Sac for tackling height 140 or 120 cm.  
 diameter 45 or 35 cm. with 3 handles



**Art. PTI.RU**  
**Lavagna Rugby bifacciale**  
**magnetica e cancellabile**  
**cm. 35x22**  
 Rugby tactical board  
 35x22 cm.



**Art. PTI.FA**  
**Lavagna Football**  
**Americano bifacciale**  
**magnetica e cancellabile**  
**cm. 35x22**  
 American Football  
 tactical board  
 35x22 cm.

**Art. CFFST**  
**Cintura Flag Football flag-a-tag**  
**colori: rosso, blu, giallo, verde**  
 Flag Football flag-a-tag  
 colors: red, blue, yellow, green



## PISCINA - Swimming Pool



**Art. E1901**  
Cuffia in poliester  
(bicolore solo taglia adulto)  
Polyester cap



**Art. E1903**  
Cuffia in lycra plus  
Lycra cap



**Art. E1127**  
Cuffia in silicone  
Silicone cap



**Art. E2607**  
Stringinaso con  
cuscinetti in silicone  
Silicone nose-clip



**Art. E2608**  
Tappi auricolari in silicone  
automodellanti - Set da 4 pezzi  
Silicone auricular plugs



**Art. E2620**  
Occhialini  
da piscina Junior  
Junior glasses



**Art. E2626**  
Occhialini  
da piscina adulto antifog  
monococca morbida  
Senior antifog glasses



**Art. E2618**  
Occhialini da piscina adulto antifog  
monococca morbida  
custodia con cerniera  
Senior antifog glasses  
case with zip



**Art. E2622**  
Occhiale maschera  
antifog monococca morbida  
con custodia rigida  
Mask glasses antifog with case

pg.44

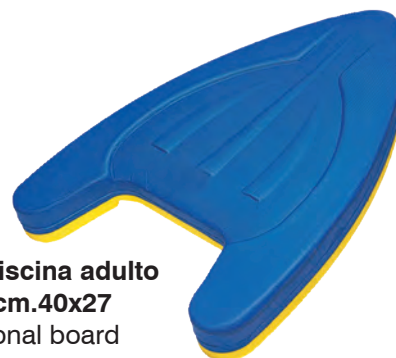

**Art. E2639**  
Tavoletta per piscina adulto  
professionale cm.40x27  
Senior professional board



**Art. E2641**  
Ostacolatore monoblocco  
cm.15x22x7,5  
Swim hinder



**Art. E2650**  
Paio palette palmari forate  
cm.21x16 (misura S, M, L)  
Pair of perforated palm palettes



**Art. E2660**  
Copriscarpe in PVC  
set da 2000 pezzi  
misura unica  
PVC shoe covers





**Art. E848**  
**Marsupio per nuoto potenziato (ad esaurimento)**  
 Swimming pouch (until available)

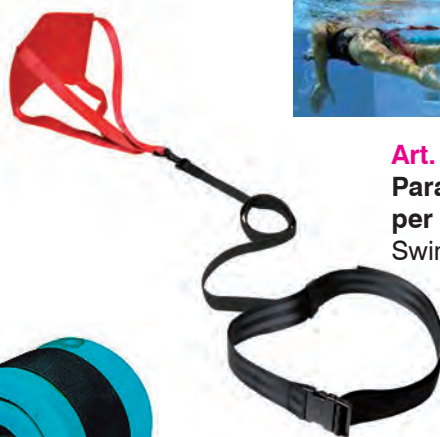

**Art. E845**  
**Paracadute per nuoto potenziato**  
 Swimming parachute



**Art. E482**  
**Paio polsiere/cavigliere per aquagym mis. cm. 62x11x2**  
 Water aerobics wrist/ankle supports



**Art. E483**  
**Paio manubri per aquagym cm.30 - diam. cm.14**  
 Water aerobics dumbbells

pg.44



**Art. E488**  
**Cintura per aquagym cm.72x24x4**  
 Water aerobics belt



**Art. E479/3**  
**Zattera in espanso forata dim. cm.200x100x3**  
 Pierced mat

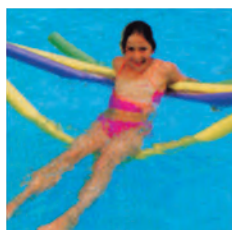

**Art. E470**  
**Cilindro in materiale espanso per aquagym cm. 160 ø cm. 7**  
 Water aerobics bar



**Art. E480/1**  
**Connettore per cilindro mis. cm.14 - 2 fori**  
 Bar connector



**Art. E2637/0**  
**Paio manicotti arrotolabili doppia valvola (3/6 anni)**  
 Brackets

**New!**



**Art. CMSAG**  
**Step per aquagym con ventose cm.67x35x17**  
 Water aerobics step 67x35x17 cm.

## PALLANUOTO - Waterpolo

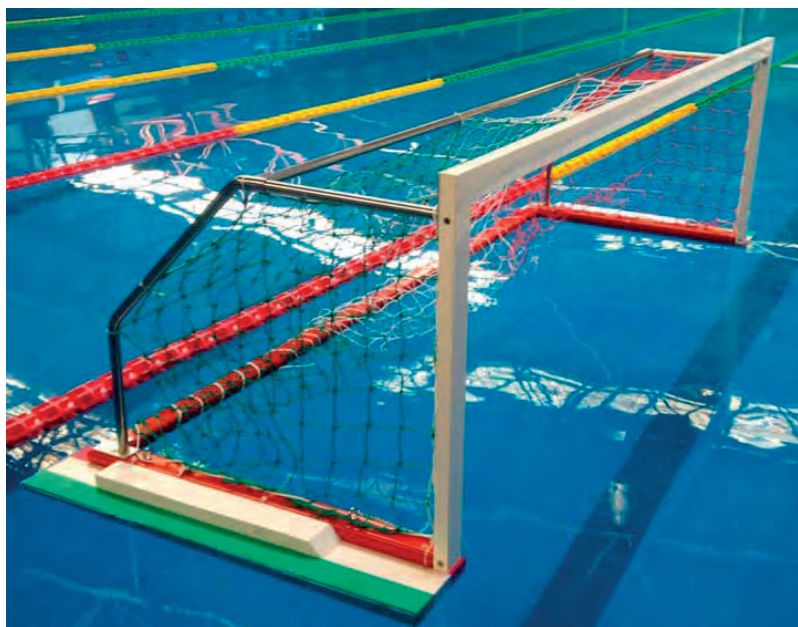

### Art. PPNR

#### Coppia Porte da pallanuoto per partite ufficiali (reti incluse)

Pair of Waterpolo Goals for official matches (nets included)

- Realizzate a norma F.I.N.A.
- Luce interna specchio di porta m.3x0,90
- Ingombro totale m.3,50x0,975x1,25
- Specchio di porta tubolare alluminio mm.75x40x1,85 di colore bianco
- Base tubolare alluminio mm.80x40x3 colore rosso
- Accessori acciaio inox AISI 316
- Galleggianti schiuma espansa a cellule chiuse densità 350% - Peso kg.30

### Art. 175P

#### Coppia reti per porte pallanuoto

Waterpolo Nets

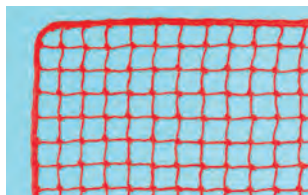

● pg.44



### Art. AQPP

#### Coppia Miniporte da pallanuoto in PVC m. 1,5x0,8 complete di reti

Pair of Waterpolo PVC Mini-goals 1,5x0,8 m. nets included



### Art. E6890

#### Pallone pallanuoto

Waterpolo Ball



### Art. 30415

#### Set 13 cuffie pallanuoto con numero colore bianco o blu

Set of 13 Waterpolo caps with numbers

## BADMINTON

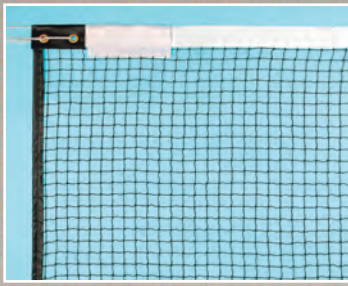

**Art. P160**  
**Rete**  
**Badminton**  
**cm. 610x70**  
Badminton Net

**V7700**  
**Impianto Badminton**  
**professionale in acciaio verniciato**  
**zavorrato, su ruote, con tendirete**  
**(rete esclusa)**  
Pro Badminton set (net not included)



**Art. BT34327**  
**Racchetta Badminton in acciaio/alluminio**  
Badminton Racket in steel/aluminium

pg.45



**Art. ASTF**  
**Racchetta Badminton Torro Fighter Club**  
**in acciaio/alluminio**  
Badminton Racket Torro Fighter Club  
in steel/aluminium



**Art. BT33106**  
**Confezione**  
**6 Volani**  
**Badminton**  
**interamente**  
**in plastica**  
Plastic  
Shuttlecock  
6 piece pack



**Art. AS85**  
**Confezione**  
**6 Volani**  
**Badminton**  
**con capsula**  
**in sughero**  
Cork tip  
Shuttlecock  
6 piece pack



**Art. 013.SP**  
**Impianto Mini Badminton cm. 450x170h. con rete e sacca**  
Mini Badminton set 4,5x1,7h. meter with net and bag

## BOXE



**Art. 992030**  
**Sacco Boxe in vinile Kg.30**  
Vinyl boxing bag kg.30



**Art. 992040**  
**Sacco Boxe in vinile Kg.40**  
Vinyl boxing bag kg.40



**Art. 992050**  
**Sacco Boxe in vinile Kg.50**  
Vinyl boxing bag kg.50



**Art. C3003S**  
**Gancio a molla**  
**ammortizzatore per**  
**sacco boxe**  
Spring for boxing bag



**Art. 993004**  
**Supporto a muro**  
**per sacco boxe**  
Iron wall support for  
boxing bag



**Art. 992840**  
**Sacco Boxe basculante**  
**h. cm. 170 zavorrato con**  
**sacchi di sabbia (inclusi)**  
Self-straightening boxing bag  
height 170 cm.



**Art. 992804**  
**Sacco Fit Boxe con pedana**  
**riempibile con acqua o sabbia,**  
**altezza regolabile (max cm. 220)**  
Freestanding Fit Boxing bag  
adjustable height



**Art. F350**  
**Kit pera**  
**su mensola**  
Pear for boxing

pg.53



**Art. 42233A**  
**Casco Boxe**  
misure S, M, L, XL  
Boxing helmet



**Art. 44613A**  
**Set protezioni**  
parastinco +  
parapiede  
misure S, M, L, XL  
Shin/foot protections

pg.53



**Art. 17211**  
**Coppia Fasce Boxe**  
Boxing bandages



**Art. 54613A**  
**Guanti da Sacco in PU**  
taglie S, M, L, XL  
Bag gloves



**Art. 21796**  
**Guanti Fit Boxe**  
taglie S, M, L, XL  
Fit Boxing gloves



**Art. 74613A**  
**Guanti MMA in PU**  
taglie S, M, L, XL  
MMA gloves

pg.53



**Art. 84613A**  
**Guanti Boxe**  
per combattimento  
non omologati  
8/10/12 oz.  
Boxing gloves



**Art. GN083**  
**Guanti Boxe**  
Leone Flash 10 oz.  
Leone Boxing  
gloves

## HOCKEY



pg.44

### Art. S05134

**Set Unihockey composto  
da 6+6 bastoni e 3 palline**

Set Unihockey made of 6+6 sticks and 3 balls



### Art. PUH01

**Pallina Unihockey**

Unihockey ball

### Art. H1

**Coppia RETI per porte da Hockey pista  
(indoor) in polipropilene maglia mm.45  
cm.300x200x100x100**

Pair of Track Hockey Goal nets

### Art. H2

**Coppia RETI per porte da Hockey  
ghiaccio in polipropilene complete di rete  
di sbarramento, maglia  
mm.20 - cm.193x122x75x120**

Pair of Ice Hockey Goal nets

### Art. H3

**Coppia RETI per porte da Hockey  
prato in polipropilene complete di rete  
di sbarramento, maglia  
mm.45 - cm.366x214x90x122**

Pair of Field Hockey Goal nets

### Art. H4

**Coppia RETI per porte da Hockey rotelle in  
polipropilene complete di rete di sbarramento,  
maglia mm.20 - cm.185x122x74x110**

Pair of Roller Hockey Goal nets



### Art. F806

**Coppia porte Unihockey  
in acciaio verniciato con reti,  
dim. cm.150x110**

Pair of Unihockey Goals in painted steel 150x110 cm.

## BASEBALL



**Art. TMB01**  
**Mazza Baseball supersoft Trial**  
 lunghezza cm.71 diametro cm.4/5  
 peso gr.460  
 Supersoft Trial Baseball bat



**Art. S05152**  
**Mazza Baseball regolamentare in legno**  
 Wooden Baseball bat



**Art. S05156**  
**Palla Baseball rivestita in pelle sintetica**  
 Baseball ball



**Art. S05158**  
**Guantone Baseball in pelle sintetica**  
 misura senior  
 Senior Baseball glove

pg.45

**Art. PTI.BB**  
**Lavagna Baseball bifacciale, magnetica e cancellabile**  
 cm. 35x22  
 Baseball tactical board  
 35x22 cm.

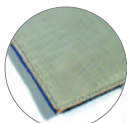

appoggio antiscivolo



**Art. P21006**  
**Set basi didattiche antiscivolo colorate**  
 Set of didactic anti-skid bases



imbottitura interna

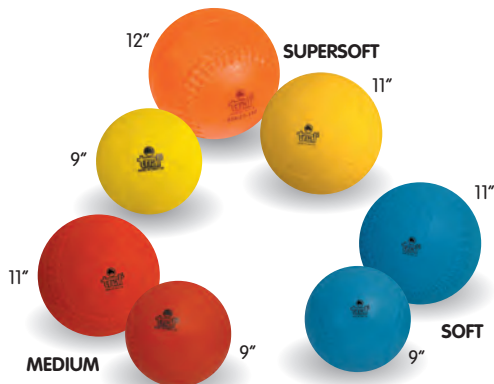

**Art. BSB.8**  
**Set 7 Palle Baseball/Softball Trial in gomma super soft**  
 diametri e grammature assortiti  
 Set of Trial Baseball/Softball balls



**Art. T21063**  
**Batting tee Trial supersoft**  
 altezza regolabile da cm. 65 a cm. 86  
 base diametro cm. 20,5  
 peso Kg. 3  
 Trial Batting tee adjustable height

## MATERASSI - TAPPETI - Mats



### Art. B2001/ ... /B2016

Materassi di caduta realizzati in gommapiuma di varie densità con fodera di rivestimento in PVC antimuffa, antibatterico, ignifugo Cl.2

(vedere listino per le dimensioni)

Mats of various dimensions and thickness

Materassi e fodere disponibili anche con fondo antiscivolo (dettagli sul listino prezzi)

Mats and covers also available with anti-skid bottom (details on price list)

pg.46

pg.47

### Art. B2033/ ... /B2047

Fodere di ricambio in PVC antimuffa, antibatterico, ignifugo Cl.2

(vedere listino per le dimensioni)

Spare covers for mats various dimensions



### Particolare Art. B2014/ B2015/B2016

(i materassi cm.200x400 sono costituiti da due metà tagliate a 45° e tenute insieme da bande in velcro)

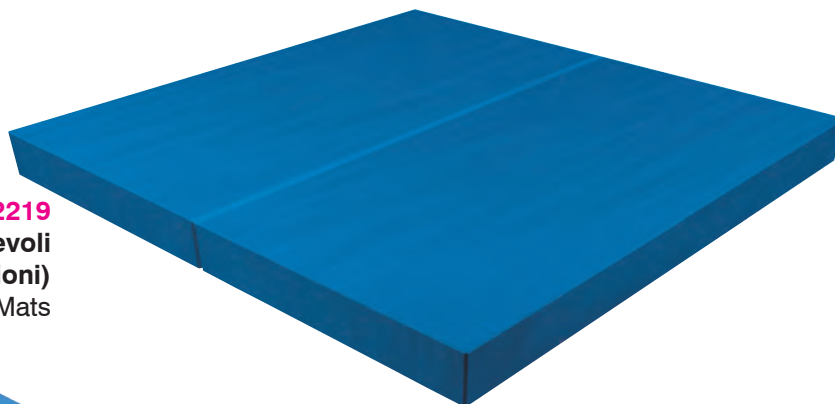

### Art. B2214/ ... /B2219

Materassi di caduta pieghevoli (vedere listino per le dimensioni)

Foldable Mats



Più rigidi e compatti dei materassi in gommapiuma  
Harder than foam rubber mats

### Art. B2228/ ... /B2231

Tappeti Gym Mat dim. cm.200x100 spessore cm.3-4-5-6 ad alta densità in polietilene a cellule chiuse per uscita attrezzi  
High density Gym Mats

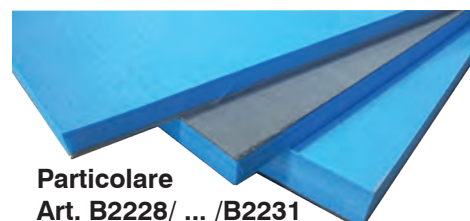

Particolare Art. B2228/ ... /B2231



**Art. S00676**  
**Carrello porta materassi**  
**cm. 200x100**  
**in acciaio verniciato**  
**mobile su ruote**  
Mat Trolley in painted steel size  
200x100 cm. on wheels



pg.47



**Art. S00678**  
**Carrello porta materassi**  
**in verticale cm. 250x105**  
**in acciaio verniciato**  
**mobile su ruote**  
**(elastici inclusi)**  
Vertical mat Trolley in painted  
steel size 250x105 cm.  
on wheels  
(elastics included)



**Art. TEST.M**  
**Tappeto Mat Test cm.100x370**  
**con scala centimetrata da 0 a cm. 300**  
Mat Test 100x370 cm.

**Per allenamento tuffi portieri ed acrobazie giocatori**  
For GK dive and players' acrobatic shooting training

pg.46

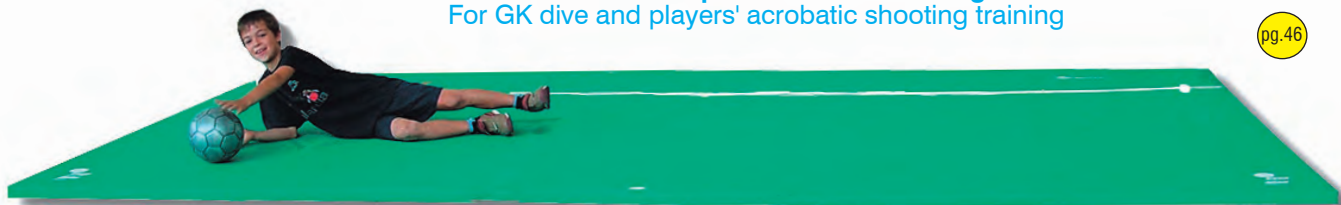

**Art. BGAP13**  
**Tappeto ammortizzante pieghevole dimensioni cm. 200x450 spessore cm. 3,5**  
**superficie in vinile, fondo antiscivolo, imbottitura in gommapiuma densità 40 Kg/mc**  
Foldable soft mat for goalkeeper and players' safe dives - size 200x450 cm. 3,5 cm. thick

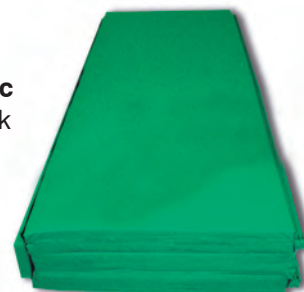

## ARTI MARZIALI - Martial Arts



**Art. 24772**  
Divisa judo con cintura  
misure da 00 (cm.120)  
a 7 (cm.200)  
Judo strip with belt

pg.53



**Art. 24773**  
Divisa karate con cintura  
misure da 00 (cm.120)  
a 7 (cm.200)  
Karate strip with belt



**Art. 23271**  
Cintura judo/karate 100% cotone  
colori: nero, blu, arancio, marrone,  
verde, giallo, rosso  
misure da 1 a 7  
Judo/Karate belt



**Art. 23271.B**  
Cintura judo/karate 100% cotone  
bicolore: bianco/giallo, giallo/arancio,  
arancio/verde, verde/blu,  
blu/marrone - misure da 1 a 7  
Bicoloured Judo/Karate belt

**Art. F150**  
Fight Timer da parete  
cm.56x19x4 - kg.1,6  
Fight Timer



## TATAMI

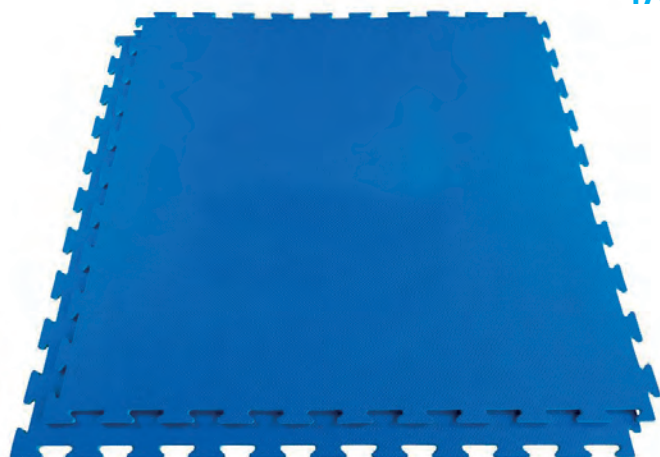

### Art. R10X

TATAMI ad incastro in EVA cm.100x100x1  
colore blu con 4 bordi  
superficie lavabile, antiscivolo  
EVA Tatami soft flooring 100x100x1 cm.

pg.53

pg.54

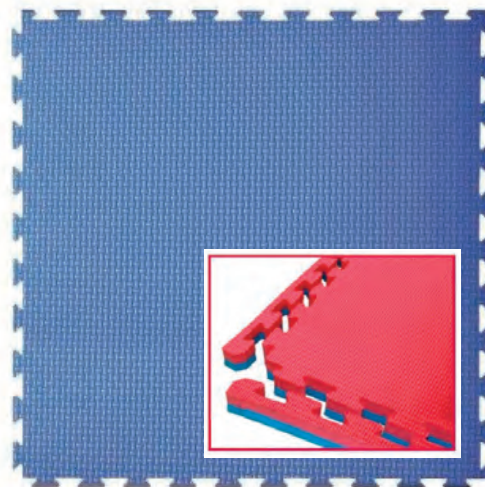

### Art. MAT02 / MAT04

TATAMI ad incastro cm.100x100x2  
o cm.100x100x4 rosso/blu con 4 bordi  
superficie lavabile, antiscivolo, antifunghi,  
antibatterica, anallergica, certificato EN71  
Tatami soft flooring 100x100x2 cm./100x100x4 cm.

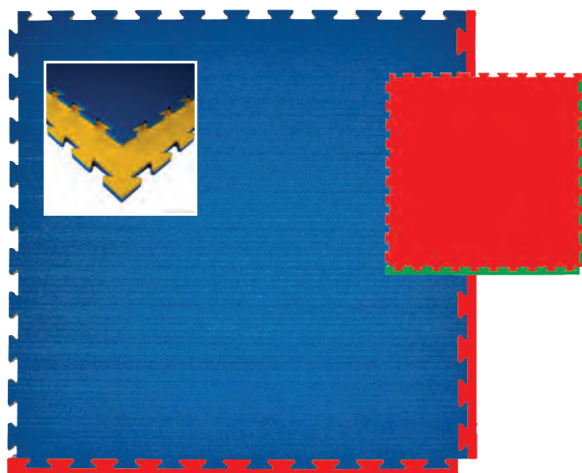

### Art. TX-K20

TATAMI Karate K20  
cm. 100x100x2 ad incastro, reversibile  
in polietilene espanso reticolato  
incluso bordo protettivo perimetrale  
colori: verde/rosso, rosso/blu, giallo/blu  
**(ordine minimo 8 pezzi)**  
TATAMI K20 100x100x2 cm.  
reversible, perimetric frame included  
colors: red/green, red/blue, yellow/blue  
(minimum order 8 pieces)

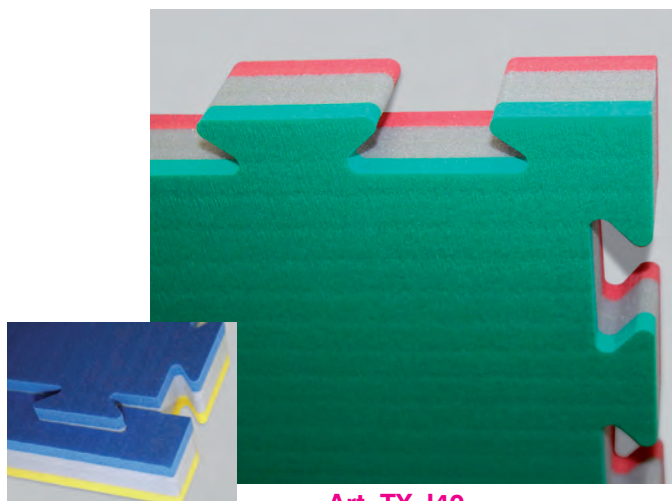

### Art. TX-J40

TATAMI Judo J40  
cm. 100x100x4 ad incastro, reversibile  
in polietilene espanso reticolato  
incluso bordo protettivo perimetrale  
colori: verde/bianco/rosso, giallo/bianco/blu  
**(ordine minimo 4 pezzi)**  
TATAMI J40 100x100x4 cm. reversible,  
perimetric frame included  
colors: red/white/green, yellow/white/blue  
(minimum order 4 pieces)



### Art. TX-2010

TATAMI tradizionale  
cm. 200x100x4 in PU  
densità 230 Kg/mc  
rivestito in PVC  
con fondo antiscivolo  
colori: blu, verde, rosso, giallo  
**(ordine minimo 4 pezzi)**  
TATAMI 200x100x4 cm.  
in PU density 230 Kg/mc  
cover with anti-skid PVC stratum  
colors: blue, green, red, yellow  
(minimum order 4 pieces)

## PROTEZIONI MURARIE E PER COLONNA - Wall protections



PREVENTIVO SU RICHIESTA  
PRICES ON REQUEST

### Art. B2085 / B2066

Protezioni murarie e per colonna in vari spessori sagomate su misura in EVA oppure in PE ad alta densità rivestito in PVC fissaggio tramite occhiellature perimetrali, velcro oppure colla per interno ed esterno

Customized wall and column protections various thickness for indoor and outdoor



pg.46

### Art. PPVCI

Protezione paraspigolo in PVC ignifugo Cl.1 lunghezza cm. 200, spessore mm. 2 larghezza cm. 3,5+3,5 in vari colori  
PVC edge protection length 200 cm. width 3,5+3,5 cm. 2 mm. thick

Si taglia facilmente alla misura desiderata e si applica rapidamente mediante normale silicone  
it can be easily cut to the desired size and installed quickly with standard silicone

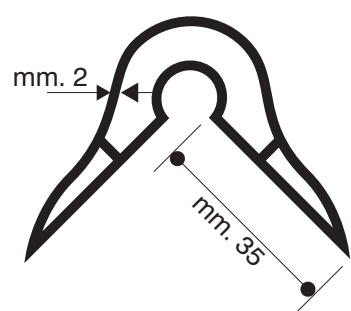

## GINNASTICA - Gymnastic



**Art. S00352**

**Armadio porta attrezzi  
a 4 ripiani in lamiera  
con vano portavalori  
dimensioni cm. 100x45x200h**  
Equipment locker with safe-deposit box



**Art. S00354**

**Armadio porta attrezzi a 4 ripiani  
in lamiera dimensioni cm. 100x45x200h**  
Equipment locker

pg.48



**Art. S00356**

**Armadio porta attrezzi  
in lamiera dimensioni  
cm. 120x45x200h  
a 4 ripiani  
e porte scorrevoli**  
Equipment locker with  
sliding doors

pg.48

**Art. S00362**  
**Mobile porta attrezzi su ruote**  
Equipment trolley on wheels

pg.23

**Art. F406**  
**Armadio porta  
attrezzi in acciaio  
zincato a pareti  
smontabili,  
con ruote  
dimensioni  
cm. 156x76x163h**  
Equipment locker in  
galvanized steel  
on wheels





**Art. CAGL**  
Coppia anelli in legno di faggio  
con cinghie nylon regolabili  
Pair of wooden rings with adjustable nylon belts

pg.48

**Art. S0002**  
Coppia anelli  
in legno lamellare  
Pair of wooden rings



**Art. S00018**  
Confezione da 8 pani  
magnesio gr. 55  
Chalk blocks



pg.48



**Art.S00512**  
Mensola porta clavette  
Club wall holder



**Art. E8000**  
Paio scarpette in pelle  
per ginnastica ritmica  
colore nero o bianco  
taglie da 26 a 46  
Pair of shoes for rhythmic gym  
color black or white

**Art. P00510/S00502/S00506**  
Coppia clavette in nylon,  
in legno a collo lungo e collo corto  
Wooden and plastic clubs

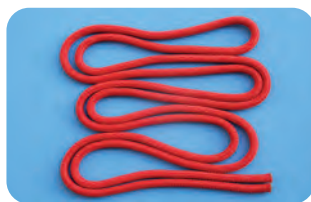

**Art. CS5**  
Corda salto  
per ritmica  
m. 3  
Jumping rope



**Art. P01210**  
Nastro per ginnastica  
ritmica m. 6  
Rhythmic  
gym streamer

pg.48



**Art. CS7**  
Corda salto  
per ritmica  
m. 3 piombata  
Weighted jumping  
rope



**Art. S01482**  
Tamburello  
completo  
di batacchio  
Rhythmic  
gym drum

pg.49

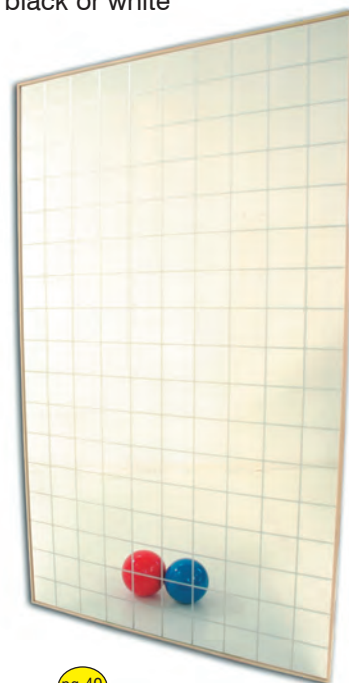

**Art. S01624**  
Specchio quadrettato  
con cornice  
in legno da fissare a parete  
misure cm.200x100  
Wall mirror with wooden frame



**Art. S01606**  
**Supporto per sbarra regolabile da fissare a parete**  
 Support for bar to be fixed on the wall

pg.49



**Art. S01608**  
**Supporto per sbarra regolabile da fissare a terra**  
 Support for bar to be fixed on the floor



**Art. S00304**  
**Coppia ceppi Baumann in legno**  
 Pair of Baumann blocks in wood

pg.48



**Art. S00302**  
**Coppia appoggi Baumann in legno**  
 Pair of Baumann supports in wood

**Art. S01602**  
**Sbarra per danza in legno**  
 (pezzo unico fino a 4 metri)  
 Wooden bar



**Art. 1156TE**  
**Supporto per sbarra regolabile da cm. 78 a cm. 140 in acciaio con base autoportante economica**  
 Cheap freestanding support for bar



**Art. S01052 / S01054 / S01060 / S01062**  
**Scale ortopediche dritte o curve, a parete o trasportabili, lunghezza m. 3**  
 Orthopaedic ladders 3 meter long

pg.49



**Art. S00772/S00774**  
**Fune per salita**  
 lunghezza m. 5/6  
 Climbing Rope length 5/6 m.

pg.48



**Art. S00754 / S00756**  
**Palchi di salita**  
 (dettagli sul listino prezzi)  
 Climbing apparatus

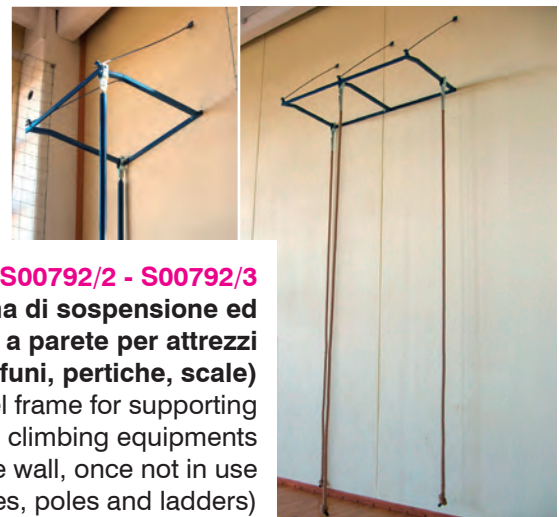

**Art. S00792/2 - S00792/3**  
**Sistema di sospensione ed accostamento a parete per attrezzi da arrampicata (funi, pertiche, scale)**  
 Varnished steel frame for supporting and sliding climbing equipments to the wall, once not in use (ropes, poles and ladders)



pg.48

pg.49



**Art. S00060 / S00064**  
**Trave di equilibrio in alluminio rivestito lunghezza mt.5 ad altezza regolabile (a norme F.I.G.) oppure ad altezza fissa**  
 Balance beam 5 meters adjustable height 50-120 cm. or fixed height

**Art. S00056 / S00058 / S00052 / S00054**  
**Assi di equilibrio ad altezza fissa e graduabile**  
 Balance beams adjustable and fixed height



pg.49



**Art. S00204 / S00206 / S00208 / S00210**  
**Pedane elastiche con piano di battuta in legno, ricoperto in gomma, ricoperto in moquette o a doppio molleggio**  
 Springboards



**Art. S00104**  
**Cavallo regolamentare per volteggio rivestito in pelle sintetica altezza regolabile**  
 Vaulting buck adjustable height

pg.48



**Art. V1168**  
**Cavallina regolamentare rivestita in similpelle altezza regolabile da cm. 90 a cm.130**  
 Vaulting buck adjustable height



pg.49

**Art. S00218 / S00220**  
**Tappeto arrotolabile per pedana corpo libero in poliuretano e moquette, rotolo da m. 15/25 larghezza cm. 100/200**  
 Gymnastic moquette floor, roll 15/25 m. long 100/200 cm. wide



pg.14

**Art. S00914/S00918/S00920**  
**Panche svedesi**  
 Swedish benches





**Art. S00252**  
**Sbarra orizzontale**  
**per volteggi regolabile in**  
**altezza, fissaggio**  
**a terra con tiranti**  
Vaulting bar adjustable height



**Art. S00160**  
**Parallela Scolastica a losanga**  
**ad altezza fissa, staggi in legno lamellare**  
School training parallel bars fixed height

pg.49



**Art. S00156**  
**Parallela Asimmetrica Femminile in acciaio verniciato**  
**su basamento pesante, montanti graduabili,**  
**staggi in legno lamellare regolabili in altezza e larghezza**  
Asymmetrical parallel bars adjustable height



**Art.S00152**  
**Parallela Maschile in acciaio verniciato**  
**su basamento pesante, montanti graduabili,**  
**staggi in legno lamellare**  
**regolabili in altezza e larghezza**  
Parallel bars adjustable height

## ATLETICA - Track & Field



**Art. PBS-SI**

**Blocco di partenza da allenamento Polanik in acciaio zincato**  
Starting Blocks Polanik in galvanized steel

pg.49

pg.50

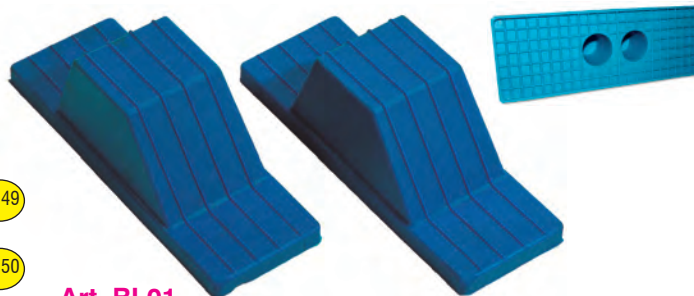

**Art. BL01**

**Paio Blocchi di partenza in gomma per palestra**  
Pair of gym Starting Blocks in rubber for beginners



**Art. S02010/PPA38**

**Testimoni per staffetta in PVC o omologati in alluminio**  
PVC or aluminium relay baton



**Art. TYVS**

**Pettorali in tyvek per gare atletica cm.21x16h personalizzabili**  
Numbers for competitions



**Art. F601**

**Ostacolo per Atletica in ferro zincato graduabile cm. 50-60-76,2**

Adjustable height hurdle in galvanized steel



**Art. S02126**

**Pistola a tamburo per starter**  
Starter's revolver gun



**Art. S02112**

**Megafono a transistor portatile**  
Handy megaphone



**Art. F602**

**Ostacolo per Atletica in ferro zincato graduabile cm. 76,2-84-91,4**

Adjustable height hurdle in galvanized steel

pg.50

**Art. PP1736A**

**Ostacolo per Atletica Polanik olimpionico da competizione in alluminio anodizzato omologato W.A.**  
Adjustable height olympic hurdle in anodized aluminium according to W.A. standards



**Art. S02064**

**Ostacolo per Atletica in acciaio zincato graduabile cm. 76,2-84-91,4-100-106,7**  
Adjustable height hurdle in galvanized steel



**Art. 6502U**

**Ostacolo per Atletica Nordicsport olimpionico da competizione in acciaio/alluminio omologato W.A.**  
Adjustable height olympic hurdle in steel/aluminium according to W.A. standards



**Art. S02552**  
Coppia ritti salto in alto scolastici altezza cm.200  
Scholastic High Jump height 200 cm.



**Art. S02554**  
Coppia ritti salto in alto scolastici in acciaio zincato altezza cm.230  
Scholastic High Jump height 230 cm.



**Art. S02556**  
Coppia ritti salto in alto in acciaio zincato periscopici h. cm.250  
High Jump height 250 cm.



**Art. S02558**  
Coppia ritti salto in alto in acciaio zincato periscopici da competizione h. cm.260  
Competition High Jump height 260 cm.

(pg.52)



**Art. S02584**  
Piattaforma zincata di sostegno e sollevamento zona di caduta  
Galvanized steel support platform for landing mats

**Art. B2080/B2081**  
Zone di caduta salto in alto  
High Jump landing mats



**Art. S02566**  
Asta segnalimite per salto in alto in PTE  
High Jump crossbar with soft PTE cylinders



**Art. PVS-CPTA**  
Coppia ritti per salto con l'asta in alluminio graduabili fino a cm. 650  
Pair of aluminium pole vault stands

**Art. B2077/B2078**  
Zone di caduta salto con l'asta  
Pole vault landing mats



**Art. S02570**  
Asticella segnalimite per salto in alto m. 4 in vetroresina  
High Jump fiberglass crossbar



**Art. TT09/ ... /VT15**  
**Palle lancio**  
**in gomma Trial**  
**varie grammature**  
 Trial rubber throwing balls



**Art. VDL5/ ... /VDL72**  
**Palle getto anelastiche**  
**in gomma Trial**  
**per indoor**  
**varie grammature**  
 Trial rubber shot balls  
 for indoor



**Art. S02486/ ... /S02496**  
**Palle getto in metallo verniciato**  
**tarate, varie grammature**  
 Metal shot balls



pg.51

**Art. S02510**  
**Pedana per lancio del peso**  
**in acciaio zincato**  
 Galvanized steel shot put throwing circle

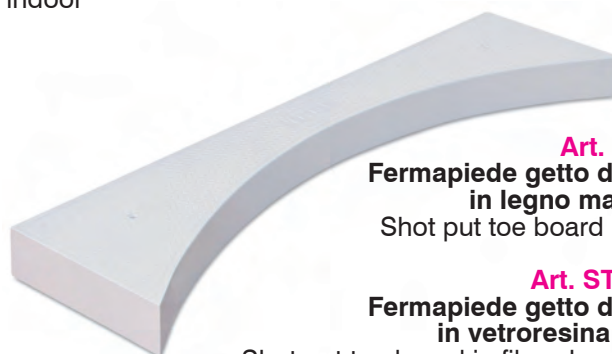

**Art. S02512**  
**Fermapiede getto del peso**  
**in legno massiccio**  
 Shot put toe board in wood

**Art. STB-F100**  
**Fermapiede getto del peso**  
**in vetroresina I.A.A.F.**  
 Shot put toe board in fiberglass I.A.A.F.



**Art. CT6**  
**Chiodo per scarpa**  
**in acciaio mm.6 modello**  
**Albero di Natale**  
**(per corsa campestre)**  
 Shoe steel stud 6 mm.



**Art. P15020**  
**Pedana Lancio in neoprene espanso**  
**per allenamento lancio del disco, giavellotto,**  
**peso, martello e salto in lungo**  
 Training toe board



pg.50

**Art. P6 / P9 / P12**  
**Chiodo per scarpa in acciaio**  
**mm.6 - mm.9 - mm.12**  
**modello Pyramid**  
**(per pista)**  
 Shoe steel stud 6 - 9 - 12 mm.



pg.52

**Art. LM0.5/ ... /LM5**  
**Martelli sicuri supersoft**  
**in gomma Trial**  
**varie grammature**  
 Supersoft Trial hammers



**Art. PM2/ ... /PM10**  
**Martelli in acciaio da allenamento Polanik**  
 Polanik steel hammers



**Art. DSK1/ ... /DSK2**  
**Dischi in gomma Trial varie grammature**  
 Discus in rubber Trial

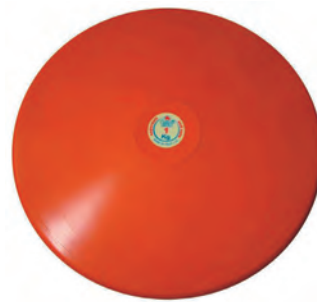

**Dischi Jet speciali per avviamento al lancio con peso distribuito sulla parte esterna per favorire la penetrazione nell'aria**  
 Special Jet discus with weight distributed mainly on the external perimeter in order to increase air penetration

**Art. JET03 / JET05 / JET1**  
**Dischi Jet in gomma Trial**  
 Kg. 0,3/0,5/1  
 Jet discus in rubber Trial

pg.50



**Art. DT0.4/ ... /DT1**  
**Dischi Trial a 3 impugnature in gomma approvati I.A.A.F. per attività scolastica**  
 Trial discus approved by I.A.A.F. for school training

**Art. W4T/ ... /W10T**  
**Giavellotti Polanik in lega leggera con puntale in acciaio varie grammature**  
 Polanik Javelins in light alloy with steel edge in various weights



**Art. TPD075/ ... /TPD3**  
**Dischi in plastica bordati in acciaio Polanik**  
 Polanik discus in plastic-steel

**Art. CPD1/ ... /CPD2**  
**Dischi in plastica bordati in acciaio Polanik - omologati I.A.A.F.**  
 I.A.A.F. Polanik discus in plastic-steel



**Art. TRTJ**  
**Turbo Jav per avviamento al lancio**  
 Turbo Jav for throwing introduction

**Art. P15262**  
**Junior Jav in polietilene espanso**  
 cm. 88 gr. 50  
 Junior Jav

**Art. JAL-C400/ ... / JAL-C800**  
**Giavellotti Vinex in lega leggera con puntale in acciaio varie grammature**  
 Vinex Javelins in light alloy with steel edge in various weights

pg.50

pg.51



**Art. VMH**  
**Vortex per avviamento al lancio del giavellotto e per football americano**  
 Vortex for throwing introduction



**Art. VMH.J**  
**Mini Vortex gr. 40 lunghezza cm. 17**  
 Mini Vortex

**PILATES**



**Art. EVA.P**  
**Mattoncino pilates in eva**  
 cm.22,5x15x7,5h  
 Block for pilates



**Art. MPS30**  
**Mattoncino pilates gonfiabile**  
 Trial soft gr. 300 cm.12x24x3,5h  
 Inflatable block for pilates

**Art. MPS50**  
**Mattoncino pilates gonfiabile**  
 Trial soft gr. 500 cm.11,3x24x5,5h  
 Inflatable block for pilates



pg.54



**Art. AHF-065/AHF-066**  
**Sfera tonificante**  
 verde kg.1 / viola kg.1,5  
 Toning balls



**Art. AHF-045**  
**Palla per yoga**  
 ø cm.25  
 Yoga ball



**Art. BA4**  
**Palla tender per pilates**  
 ø cm.20 - gr. 180  
 super soffice e sicura  
 Trial rubber tender ball  
 for pilates



**Art. TR38**  
**Toning ring**  
 Toning ring



**Art. AHF-001**  
**Coppia sfere per massaggi**  
 verde ø cm.7,5  
 viola ø cm.9  
 Massage balls



**Art. AHF-020**  
**Power grip ball**  
 Power grip ball



pg.21

**Art. B55 / B75**  
**Relax Ball Trial**  
 ø cm.5,5 / 7,5  
 Relax Ball



**Art. FY9512**  
**Fitball roller**  
 gonfiabile  
 ø cm.18  
 Fitball roller inflatable



**Art. 995025**  
**Cilindro pieno**  
 Foam roll  
 lunghezza cm. 90  
 ø cm.15  
 Foam roll not  
 inflatable



**Art. 995025BIS**  
**Mezzo cilindro**  
 pieno Foam roll  
 lunghezza cm. 90  
 altezza cm.7,5  
 Half Foam roll  
 not inflatable



**Art. AHF-044**  
**Rullo massaggio**  
 lunghezza cm.33  
 ø cm.14  
 Massaging roll



**Art. AHF-111**  
**Rullo massaggio**  
 con impugnature  
 cm.53 ø cm.4,5  
 Massaging roll



pg.23



**Art. TBSA/TBSB**  
**Palla Boa** autobilanciante in gomma Trial  
 oscilla ma torna al suo posto senza rotolare,  
 stabile, ideale per correggere la postura,  
 monocolore per adulti/bicolore per bambini  
 Trial rubber Boa Ball swings but comes back  
 to its original position - very good for postural  
 therapy for adults and children

## PALLAPUGNO - BOCCE - TAMBURELLI



pg.54

**Art. BA1**  
Air Ball Trial Ø cm. 12 gr. 100  
morbida e rimbalzante  
(ideale anche per pallapugno)  
Trial Air Ball



**Art. M05010**  
Pallapugno FIPAP  
Ø cm. 14 gr. 65  
FIPAP pallapugno



**Art. ST14**  
Palla Canguro Ø cm. 45  
Trial Cangaroo Ball



**Art. ST15**  
Palla Canguro Ø cm. 55  
Trial Cangaroo Ball



**Art. ST16**  
Palla Canguro Ø cm. 65  
Trial Cangaroo Ball



**Art. ASKB**  
Set 8 bocce in  
legno laccato Ø mm. 100  
con pallino Ø mm. 40  
Set 8 wooden bowls

**Art. BTST12**  
Set 6+6 bocce supersoft  
con pallino e borsa  
Set of 12 supersoft  
bowls with bag

pg.54



**Art. P18110**  
Tamburello indoor  
Ø cm. 26  
(fino a 13 anni)  
omologato FIPT  
FIPT indoor  
tamburello Ø cm. 26



**Art. P18111**  
Tamburello indoor  
Ø cm. 28  
omologato FIPT  
FIPT indoor tamburello  
Ø cm. 28



**Art. S00552 / S00556**  
Fune per tiro alla fune  
lunghezza m. 15 / m. 25  
con indicazioni colorate  
Rope for tug of war  
length 15 m. / 25 m.



**Art. PT41**  
Pallina per tamburello  
depressurizzata  
indoor Ø cm. 6,5 gr. 40  
Tamburello indoor  
depressurized ball

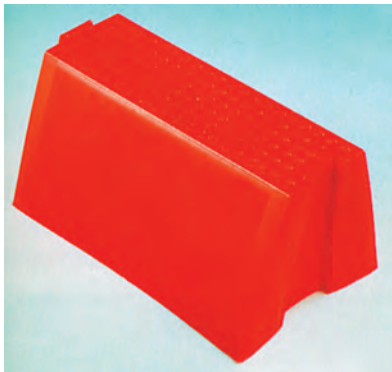

**Art. I-059**  
**Set 10 mattoncini dritti**  
**cm. 25x16x13h**  
 Set of 10 straight bricks

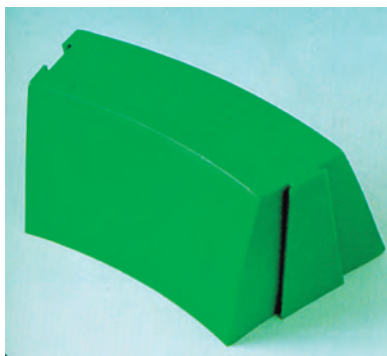

**Art. I-060**  
**Set 10 mattoncini curvi**  
**cm. 22x16x13h**  
 Set of 10 curved bricks

pg.54

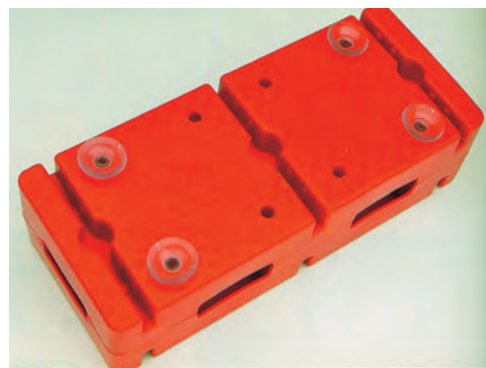

**Art. I-098**  
**Blocco percorso**  
**cm. 30x15x10h**  
 Block for route

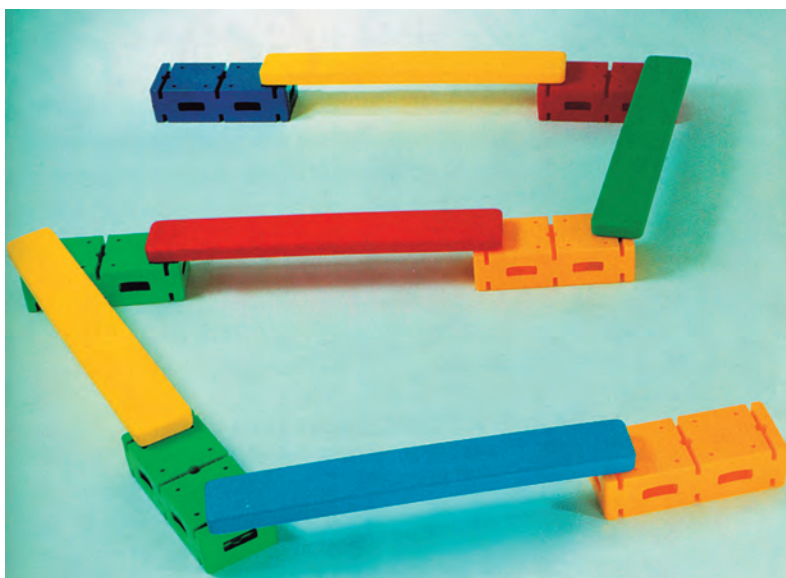

**Art. I-061**  
**Percorso equilibrio composto da 5 assi + 6 mattoncini + 24 ventose**  
 Balance route



**PALLA  
 AVVELENATA  
 Dodgeball**



**Art. TDB16**  
**Palla per Dodgeball diametro cm. 16**  
**peso gr. 210 colore arancio fluo**  
 Dodgeball Ø 16 cm.

pg.54

**Art. TDB20**  
**Palla per Dodgeball diametro cm. 20**  
**peso gr. 230 colore giallo fluo**  
 Dodgeball Ø 20 cm.

**Special  
 Price**





**SKATEBOARD - PATTINI - MONOPATTINI - FRISBEE**



**Art. SKM2401** Skateboard Junior cm. 61  
Junior Skateboard 61 cm.



**Art. SKM3103** Skateboard Senior cm. 77,5  
Skateboard 77,5 cm.



**Art. F4-400**  
Casco Skate  
taglie S, M, L  
Skate helmet

ad esaurimento  
until available



pg.54

**Art. GDA20**  
Bersaglio elettronico  
per il gioco delle  
freccette (incluse 6  
freccette e 40 punte di  
ricambio)  
Darts electronic target  
(including 6 darts and 40  
spare tips)



ad esaurimento  
until available

**Art. 681171**  
Set 3 protezioni Junior  
Junior protections

**Art. 132171**  
Set 3 protezioni Senior  
(misura S, M, L)  
Senior protections



**Art. SKJP-G**  
Pattino in line  
allungabile Junior  
taglie: 30/33 - 34/37 - 38/41  
In line skate adjustable size

ad esaurimento  
until available



**Art. ML9200**  
Monopattino  
pieghevole,  
ruote Ø mm. 200  
peso massimo  
utilizzatore kg. 100  
Scooter

pg.54

ad esaurimento  
until available



**Art. ML8125**  
Monopattino  
pieghevole,  
ruote Ø mm. 125  
peso massimo  
utilizzatore kg. 50  
Junior Scooter



pg.54

**Art. AHF-084**  
Bastoncini  
Nordic  
Walking  
con altezza  
regolabile da  
65 a 135 cm.  
(3 tipi di punte  
incluse)  
Nordic Walking  
sticks with adjustable  
height from  
65 to 135 cm.  
(3 types of tips included)



**Art. FRPPR**  
Frisbee  
Ø cm. 27  
gr. 110  
Frisbee

## INDICE ALFABETICO

Archi di precisione - Precision Arcs .....	pag.	47
Arredi spogliatoio ed infermeria - Locker and infirmary room .....	pag.	168-173
Arti marziali, Boxe - Boxing, Martial Arts .....	pag.	212-213;218
Atletica - Track and Field .....	pag.	226-229
Attrezzi speciali, Scalette e Bande elastiche - Special Training tools, Speed Ladders and Elastic Bands .....	pag.	72-88
Badminton .....	pag.	211
Bandierine e accessori per arbitro - Flags and referee's accessories.....	pag.	118-123
Barriera filtrante, Barriera con finestre - Reflex Training Device, Window Barrier.....	pag.	50
Basket .....	pag.	177-184
Beach Soccer .....	pag.	175
Beach Volley .....	pag.	192-193
Borse - Bags .....	pag.	136-137
Casacche, Pantaloncini, Calze - Mesh shirts, Shorts, Socks .....	pag.	100-101
Contenitori Portapalloni - Baskets for balls.....	pag.	135
Cross Training, Reti per calci di precisione - Cross Training, Precision shooting nets.....	pag.	152-153
Delimitatori e Birilli - Markers and Cones .....	pag.	30-34
Deviatori di traiettoria, Ball Playning - Deviators, Ball Playning .....	pag.	61-63
Fitness Equipment.....	pag.	90-98
Forche - Heading Trellises .....	pag.	48-49
Ghiaccio, Tape, Creme, Oli - Ice, Tape, Creams, Oils.....	pag.	114-115
Ginnastica - Gymnastic .....	pag.	221-225
Hockey, Baseball .....	pag.	214-215
Impianti Multifunzione - Multi purpose systems .....	pag.	196
Kit Calcio Tennis - Soccer Tennis kits.....	pag.	44-46
Kit tecnico Scuola Calcio - Soccer School kit.....	pag.	89
Lavagne Tattiche - Tactical Boards.....	pag.	110-113
Materassi, Protezioni Murarie - Mats, Wall Protections.....	pag.	216-217;220
Materassini, Borracce - Mats, Water Bottles .....	pag.	109;116-117
Minivolley, Superminivolley .....	pag.	191
Muri e Telai con rete - Rebounders and Iron Frames with net .....	pag.	51-60
Numeri Termosaldabili - Numbers for uniforms .....	pag.	108
Ostacoli ad altezza fissa e regolabile - Hurdles fixed and adjustable heights.....	pag.	29;35-43
Paletti Slalom - Slalom Poles.....	pag.	25-28
Pallamano - Handball .....	pag.	197
Palle Mediche, Ritmiche e Psicomotorie - Medicine, Rhythmic and Gym Balls.....	pag.	130-133
Palloni in pelle ed in gomma - Leather and rubber Balls .....	pag.	126-129
Panchine Allenatori - Trainers' Dug-outs.....	pag.	155-161
Parastinchi, Fasce Capitano, Guanti Portiere - Shinguards, Captain Armbands, GK Gloves .....	pag.	106-107
Pilates, Didattica Scolastica, Pattini e Skateboard - Pilates, School Products, Skates .....	pag.	230-233
Piscina, Pallanuoto - Swimming Pool, Waterpolo .....	pag.	208-210
Pompe, Compressore, Cronometro e Rotelle Metriche - Pumps, Inflator, Chronometer, Measuring Tapes .....	pag.	124-125
Porte regolamentari, ridotte, miniporte, porte bifrontali - Official goals, reduced goals, minigoals, 2 side goals .pag.	pag.	138-147
Protezioni - Protections.....	pag.	194-195
Reti di Protezione - Protection Nets.....	pag.	154
Reti regolamentari e ridotte - Nets all sizes.....	pag.	148-151
Rugby.....	pag.	206-207
Sagome e Barriere - Mannequins and Barriers.....	pag.	12-24
Sedute per gradinate e Tribune modulari per interno ed esterno - Stadium seats and Stands .....	pag.	165-167
Segnalatori manuali ed elettronici per cambio giocatori - Substitution Boards .....	pag.	122-123
Strutture instabili e Tavole Propriocettive, Plinti - Equilibrium Boards.....	pag.	64-70
Tabelloni elettronici segnapunti - Electronic scoreboards.....	pag.	198-200
Tacchetti ed accessori per scarpe, Lavascarpe - Studs and shoe accessories, Shoe Washing Device.....	pag.	102-105
Tavoli calcetto - Soccer tables .....	pag.	176
Tennis Tavolo - Table Tennis .....	pag.	204-205
Tennis, Beach Tennis, Padel, Pickleball .....	pag.	201-203
Trampolini - Trampolines .....	pag.	71
Tunnel uscita spogliatoi - Stadium Tunnels.....	pag.	174
Vernice Segnacampo, Carrelli traccialinee - Ecological Paint, Line Markers.....	pag.	162-164
Volley.....	pag.	185-190



NEW VIDEOS ON  
WWW.BARRETSport.COM



**BARRET**®

ATTREZZATURE PER L'ALLENAMENTO DEI CAMPIONI  
TRAINING TOOLS FOR CHAMPIONS



## BARRET SRL

Via Marie Curie, 6/8  
Zona Ind.le S. Pietro in Palazzi  
57023 Cecina (LI) - Italy  
tel. (+39) 0586 661215  
fax (+39) 0586 662417  
info@barretsport.com  
www.barretsport.com

